



Engineering progress
Enhancing lives

RAUTHERMEX and RAUVITHERM Pre-insulated pipe systems

Technical Information



Contents

01	Information and safety instructions	5
02	Introduction	7
02.01	The future of heat supply	8
02.02	REHAU heat supply systems	9
02.03	Solutions for heat supply	10
03	Material properties	11
03.01	Carrier pipes	11
03.01.01	District heating: PE-Xa SDR 11 carrier pipe	12
03.01.02	District heating for increased pressure resistance: PE-Xa SDR 7.4 carrier pipe	13
03.01.03	Drinking water: PE-Xa SDR 7.4 – Universal pipe RAUTITAN flex	13
03.01.04	Continuous quality control	14
03.02	RAUTHERMEX SDR 11/SDR 7.4	15
03.02.01	Pipe insulation	15
03.02.02	Outer jacket	16
03.02.03	Dimensions	16
03.03	RAUVITHERM SDR 11	18
03.03.01	Pipe insulation	18
03.03.02	Outer jacket	19
03.03.03	Dimensions	19
04	Jointing technology and secondary insulation	20
04.01	Compression sleeve jointing technology	20
04.02	FUSAPEX jointing technology	24
04.03	Screw/compression connections	26
04.04	Clip shroud system for RAUTHERMEX	27
04.05	Heat-shrink shroud system for RAUVITHERM and RAUTHERMEX	28
04.06	Shroud foam for secondary insulation	30
04.07	Custom accessories	31
04.07.01	REHAU NEXUS	31
04.07.02	Y-pipe	33
04.07.03	Pre-insulated shut-off valve	35
04.07.04	Pre-insulated T-branches 125–160 (steel)	36
05	Building connection and wall entry	37
05.01	Wall penetrations	38
05.02	Core drill holes	39
05.02.01	Wall seal and expanding mortar	39
05.02.02	Sealing flange	40
05.03	Sealing with roughened pipe insert	42
05.04	Sealing with REHAU wall entry set	42
05.05	Building entries	43
05.05.01	Prefabricated lead-in bend (rigid)	43
05.05.02	Duct assisted building entries	44
05.06	End caps	45
05.07	Expansion/fix point clamps	46

06	Designing and dimensioning heat networks	47
06.01	Types of heat networks	48
06.02	Connection options	49
06.03	Network sizing	50
06.03.01	Understanding the heat requirement	51
06.03.02	Clarification of the heat supply and buffer store concept	51
06.03.03	Establishing the pipe route and location of the energy centre	52
06.03.04	Determining load diversity	52
06.03.05	Sizing of the heat source and buffer store	54
06.03.06	Establishing the required velocity/temperature drops	55
06.03.07	Pre-dimensioning the heat network pipes / identifying the critical path	56
06.03.08	Final dimensioning	58
06.03.09	Pump sizing	59
06.04	Heat losses RAUTHERMEX and RAUVITHERM pipes	63
06.05	Temperature and pressure limits	66
06.06	Service life calculation with the Miner's rule	67
06.07	Connection questionnaire for a district heating network	68
06.08	Project questionnaire for a district heating network	68
07	Installation of the heat network	69
07.01	Transport and storage	69
07.02	Installation methods	71
07.02.01	General information	71
07.02.02	Open trench installation	72
07.02.03	Pull-through technique	72
07.02.04	Mole ploughing technique for RAUTHERMEX	73
07.02.05	Horizontal directional drilling for RAUTHERMEX	73
07.03	Trench dimensions and pipe spacing	75
07.03.01	Trench widths	75
07.03.02	Proximity to other services	76
07.03.03	Protecting the pipes in special installation situations	76
07.04	Flexibility	77
07.05	Bending radii and bending forces	77
07.05.01	Bending radii	77
07.05.02	Bending forces	78
07.06	Handling the pipes during installation	79
07.07	Special installation situations	82
07.08	Tapping into existing lines	83
07.08.01	Squeeze-off tool	83
07.08.02	NEXUS tapping saddle	84
07.09	Installation aids	84
07.09.01	Horizontal unwinding device	84
07.09.02	Vertical pipe decoiler	84
07.09.03	Pipe twisting tool (DUO pipes)	85
07.09.04	STRAITA installation aid	85
07.10	Average approximate times for installation and assembly in practice	86
08	Commissioning and operation	88
08.01	Requirements on heating water	88
08.01.01	General	88
08.01.02	Commissioning	89
08.01.03	Operation, maintenance, servicing	90
08.01.04	Water treatment	90
08.01.05	Water sample for external analysis in the laboratory	90
08.01.06	Central filter station	91
08.02	Pressure test	91
08.02.01	Principles of the pressure test	91
08.02.02	Pressure test with water	91
08.02.03	Pressure test certificate	92
	Standards and guidelines	94
	REHAU Service	96
	REHAU Sales Offices	102



This Technical Information "RAUTHERMEX and RAUVITHERM Pre-insulated pipe systems" is valid from February 2022.

With its publication, the previous Technical Information 817602 (date March 2014) and its supplement 817602-ERG (date January 2019) become invalid.

You will find our current technical documentation available for download at www.rehau.uk/districtheating.

This document is protected by copyright. The rights conferred therein are reserved, in particular those relating to the translation, reprinting, extraction of pictures, electronic transmissions, reproduction by photo-mechanical or similar means and storage on data processing equipment.

All dimensions and weights are guide values. Subject to errors and modifications.

01 Information and safety instructions

Validity

This Technical Information is valid for United Kingdom.

Navigation

You will find a detailed table of contents with hierarchical headings and corresponding page numbers at the start of this Technical Information.

Pictograms and logos



Safety information



Legal notice



Important information to observe



Your benefits



Information available online

Currentness of the Technical Information

To ensure your safety and the proper use of our products, please regularly check whether a more recent version of the Technical Information is available. You will find the issue date of your Technical Information on the bottom right-hand side of the back cover and on the inside of the title page. You can obtain the current Technical Information from your REHAU Sales Office, specialist wholesaler or you can download it from the internet at.

Intended use

The REHAU pipe systems must only be designed, installed and operated as described in this Technical Information or in the installation instructions associated with the individual components. Any other use is not in accordance with the specification and is therefore not permitted. For more detailed advice, please contact your REHAU Sales Office.

Use in line with specification means compliance with all of the information in this Technical Information as well as the assembly, operating and maintenance instructions. No liability can be accepted for any use which is not in line with the specifications or inadmissible alterations to the product or any consequences resulting from this.

Safety instructions and operating instructions

- For your own safety and the safety of other people, please read through all safety instructions and operating instructions carefully and completely before commencing installation.
- Keep the operating instructions safe and have them available.
- If you do not understand the safety instructions or the individual installation procedures, or if something is unclear, please contact your REHAU Sales Office.
- Failure to follow the safety instructions can result in damage to property, environment or personal injury.

Observe all national and international pipe laying, installation, accident prevention and safety regulations as well as the notes in this Technical Information when installing pipe systems.

Also observe the applicable laws, standards, guidelines and regulations (e.g. DIN, EN, ISO, DVGW, TRGI, VDE and VDI) as well as regulations on environmental protection, regulations of the Employer's Liability Insurance Association and specifications of the local public utilities companies. Please ensure that the guidelines, standards and regulations are the valid issue in each case.

The planning and installation instructions relate directly to the relevant REHAU product. At points, we will refer to generally applicable standards or regulations. More specific standards, regulations and instructions relating to the planning, installation and operation of drinking water or heating systems or systems for building services must also be observed and do not form part of this Technical Information.

Application areas which are not covered by this Technical Information (special applications) require consultation with our Technical Applications Department.

For more detailed advice, please contact your REHAU Sales Office.

Prerequisites for personnel

- Our systems must only be installed by authorised and trained persons.
- Only trained and authorised personnel may work on electrical installations or pipework components.

General precautions

- Keep your workplace clean and free of obstructions.
- Ensure that your work space has adequate lighting.
- Keep children, pets and unauthorised persons away from tools and installation areas. This applies in particular to renovations in occupied areas.
- Only use the components intended for your particular REHAU system. The application of components from other systems or the use of tools which do not come from the relevant REHAU installation system can result in accidents or other hazards.

Working clothes

- Wear safety glasses, appropriate working clothes, safety shoes, a protective helmet and, if you have long hair, a hairnet.
- Do not wear loose-fitting clothing or jewellery, as they may get caught in moving parts.

During installation

- Always read and follow the operating instructions for the REHAU installation tool you are using.
- Incorrect handling of tools can cause serious cut injuries, crushing or removal of limbs.
- Incorrect handling of tools can damage connecting components or cause leaks.
- The REHAU pipe cutters have a sharp blade. Store and handle them in such a way that there is no risk of injury from the REHAU pipe cutters.
- When shortening pipes, make sure to maintain the safety gap between the holding hand and the cutting tool.
- During the cutting procedure, never reach into the cutting area of the tool or touch moving parts.
- After the expanding procedure, the expanded pipe end returns to its original shape (memory effect). Do not place any foreign objects in the expanded pipe end during this phase.
- During the pressing procedure, never reach into the pressing zone of the tool or touch moving parts.
- Until the pressing procedure is complete, the fitting can fall out of the pipe. This is an injury hazard.
- During all maintenance or refitting work and when changing installation areas, always unplug the tool and make sure that it cannot be switched on unintentionally.

Operating parameters

- If the operating parameters are exceeded, this leads to overstressing of the pipes and connections. It is therefore not permitted to exceed the operating parameters.
- Compliance with the operating parameters is to be ensured through safety and control systems (e.g. pressure reducer, safety valves and similar).

System-specific safety warnings

- Deburr or remove edges on insulating sleeves in order to prevent possible injury.
- When working with PUR shroud foam (polyol and isocyanate components) the safety data sheets must be observed and chemicalresistant protective gloves and protective goggles worn at all times.
- A dust mask must be worn when sawing or sanding PUR rigid foam.
- When welding electrofusion couplers and foam moulding with PUR shroud foam, the component heats up.
- When working with tension belts to fix the pipes there is a crushing risk. Do not reach into the hazardous areas.

02 Introduction



Image credit: Naturstrom AG

Heating technology of tomorrow: Environmentally friendly, economical and efficient

With 23% of our total UK emissions coming from how we heat our buildings, clearly we need to move away from fossil fuels to reach net zero by 2050. With gas boilers being banned by 2025 for new build homes, developers are now already looking at alternative ways to heat our buildings. This is where district heating can play a major role.



District heating networks with REHAU polymer pipe systems offer a series of advantages over systems with steel pipes. You can find out more at: www.rehau.uk/districtheating.

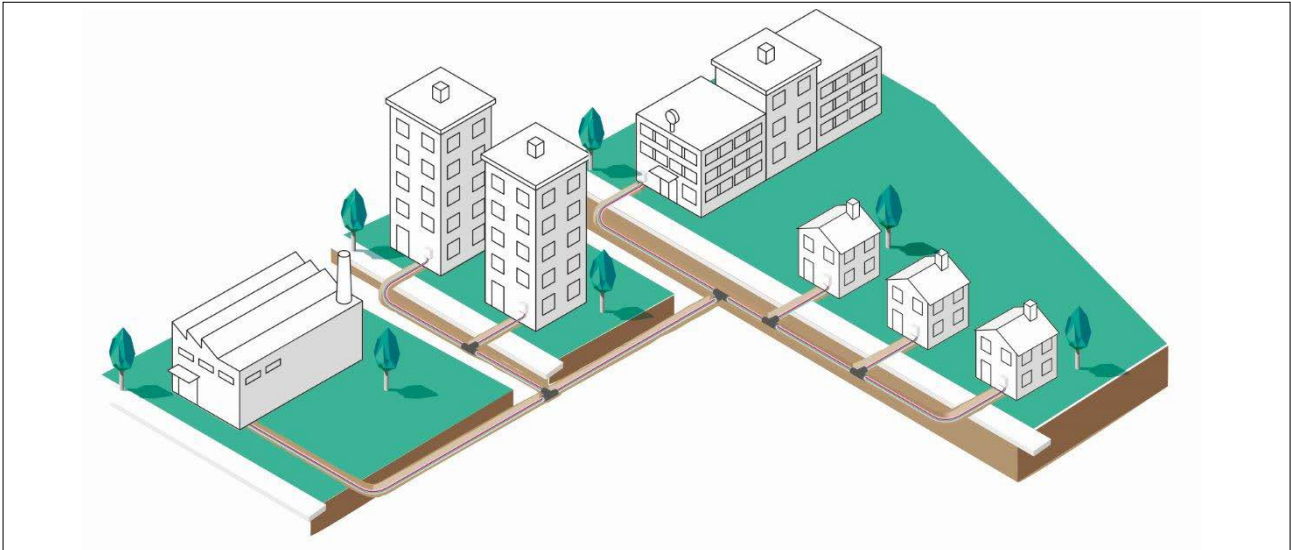

02.01 The future of heat supply

What is district heating?

District Heating is the concept of one large energy centre to provide the heat demand for a number of properties, residential, commercial or multi occupancy. The Energy Centre can use a variety of heat sources. Historically many projects used fossil fuels such as gas or gas CHP. New low carbon schemes are using heat sources such as waste heat or renewable energy sources such as air, ground or water source heat pumps, biomass or anaerobic digestion.

The hot water travels through an underground insulated pipe network to a heat interface unit (HIU) located in each building, this provides heating and hot water to each building and allows individual temperature control to each building. The cold water then returns back to the energy centre to be heated and circulated again. The heat can be distributed within the building via underfloor heating or radiators.



More and always up-to-date information on the topics

- Case studies
- Cost effectiveness
- Services
- Flexibility
- Events
- Safety
- Network efficiency

as well as other documents (installation instructions, price lists, etc.) are available online in electronic form at www.rehau.uk/districtheating.

The future is energy networks

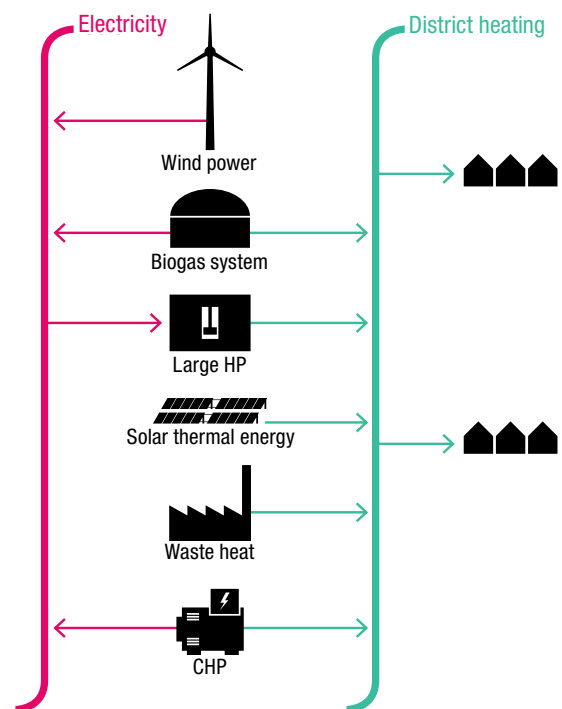

02.02 REHAU heat supply systems

This future of sustainable heat supply can be realised with the district heating network solutions from REHAU. The Technical Information applies for the design, installation and use of the pre-insulated pipe systems RAUVITHERM and RAUTHERMEX.

Applications:

- District heating supply
- Drinking and hot water supply
- Cooling technology
- Industry and agriculture
- Connection of air-to-water heat pumps
- Ground-source connecting pipes

System components:



Fig. 02-1 RAUTHERMEX



Fig. 02-2 RAUVITHERM



Fig. 02-3 Compression sleeve technology



Fig. 02-4 FUSAPEX welding technology



Fig. 02-5 Clip shroud system



Fig. 02-6 Heat-shrink shroud system



Fig. 02-7 NEXUS live tapping saddle



Fig. 02-8 Solutions for house connections, e.g. wall sealing flange

02.03 Solutions for heat supply

RAUVITHERM – The flexible solution

Thanks to several soft insulating foam layers and the corrugated, robust outer jacket, RAUVITHERM is a pipe system that is highly flexible and very robust at the same time. This also enables extremely complex connections in heat networks as well as connections in cramped space conditions.



RAUVITHERM non-bonded pipe system

System properties

- Fully sealed slip pipe system achieved by welding of the solid jacket and top layer of insulation
- Corrugated outer jacket ensures flexibility with low bending forces and small bending radii
- Robust, solid jacket suitable for construction sites
- High thermal insulation due to the multi-layer composition and low thermal conductivity of the insulating layers
- High operating safety thanks to the corrosion resistance of the materials used
- Pipe coil lengths of up to 300 m reduce the use of couplers and guarantee high laying speed
- Complete pipe and fittings product range:
 - UNO pipes (up to 160 mm pipe diameter)
 - DUO pipes (up to 2 x 63 mm pipe diameter)

RAUTHERMEX – The energy-efficient solution

The excellent thermal insulation properties of the polyurethane foam insulation and the corrugated outer jacket make RAUTHERMEX a pipe system that keeps heat losses in operation particularly low, without lacking a high degree of flexibility.



RAUTHERMEX bonded pipe system

System properties

- Highest thermal insulation in its class due to the special process technology, fine-pored PU foam and additional insulation thickness option (plus dimension)
- pipe coil lengths up to 570 m allow very long stretches with no couplings
- No expansion bellows or compensators required during installation
- Durable due to corrosion-free materials, water-tight secondary insulation and fully bonded pipe system
- Complete pipe and fittings product range:
 - UNO pipes (up to 160 mm pipe diameter)
 - DUO pipes (up to 2 x 75 mm pipe diameter)

03 Material properties

03.01 Carrier pipes

The water-bearing carrier pipe in RAUVITHERM and RAUTHERMEX is made from high pressure cross-linked polyethylene PE-Xa. The carrier pipes are cross-linked via the addition of peroxide under high pressure and at a high temperature. During this process the macromolecules combine to form a three-dimensional, stable network. PE-Xa pipes are produced to DIN 16892/DIN 16893 and DIN EN ISO 15875 in the pressure levels SDR 11 or SDR 7.4 (in accordance with the DVGW standard W 544, W 270 and BGA KTW). The REHAU carrier pipes for the district heating application also fulfil the requirements of DIN EN 15632 1–3.



- Very high chemical resistance (DIN 8075 Supplementary sheet 1)
- Very low roughness ($k = 0.007$ mm)
- Permanently low pressure loss
- Long-term corrosion resistance
- High shape retention
- Temperature resistance, even in the event of failure
- High pressure resistance
- Robust and flexible at the same time
- Excellent resistance to point loads

Technical data – carrier pipes

Designation	Value	Standard	
Density ρ	0.94 g/cm ³	ISO 1183	
Mean coefficient of linear thermal expansion (0 °C–70 °C)	$1.5 \cdot 10^{-4}/K$	–	
Thermal conductivity λ	0.35 W/m·K	Based on ASTM C 1113	
Modulus of elasticity E	at 20 °C	600 N/mm ²	ISO 527
	at 80 °C	200 N/mm ²	ISO 527
Surface resistance	$10^{12} \Omega$	–	
Building material class	B2 (normal flammability)	DIN 4102	
Surface roughness coefficient k	0.007 mm	–	
Oxygen tightness	at 40 °C	0.16 mg/(m ² ·d)	DIN 4726
	at 80 °C	1.8 mg/(m ² ·d)	

Tab. 03-1 Material properties of PE-Xa carrier pipes



The term “SDR” stands for “Standard Dimension Ratio” and describes the ratio of the external diameter to the wall thickness of the pipe, see Fig. 03-1.

The SDR number therefore serves indirectly to determine the pressure resistance. The smaller the SDR number, the thicker and therefore more pressure-resistant is the pipe. SDR 11 and SDR 7.4 demonstrate a high pressure resistance.

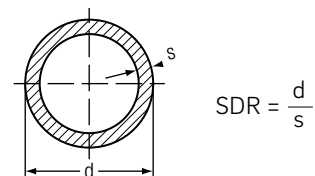

Fig. 03-1 SDR

- d External diameter [mm]
- s Wall thickness [mm]

03.01.01 District heating: PE-Xa SDR 11 carrier pipe

The REHAU PE-Xa SDR 11 carrier pipes for heating application are particularly temperature-resistant and are mainly used in closed-circuit systems for the transport of heating water. For this reason, they have an additional oxygen diffusion barrier made of EVOH to DIN 4726. The pipes have a special stabilisation in order to meet the high temperature requirements of the heat network. The colour of these pipes is orange.



Fig. 03-2 SDR 11 carrier pipes for district heating

Pressure and temperature resistance

The SDR11 carrier pipes used in the RAUVITHERM and RAUTHERMEX pipe systems are manufactured and tested in accordance with the requirements of DIN EN 15632. The following table specifies the temperature and pressure limits that apply to these SDR 11 carrier pipes under the respective continuous temperatures and safety factors. The test requirements according to DIN EN 15632 that are significantly higher as compared to DIN 16892 and DIN 16893 are met through an improved thermal stabilisation in the material formula. Tab. 03-2 mentions the minimum service life for the area of application at operating temperatures from 50 °C to 95 °C. It uses the Arrhenius conversion model analogue to the procedure according to DIN 16892 and DIN 16893.

The table uses different safety factors (SF) based on the permissible operating pressure depending on the measured temperature:

- In normal operation at continuous temperatures ≤ 80 °C, SF_D = 1.5 is used.
- In normal operation at continuous temperatures > 80 °C, a reduced SF_D = 1.3 is used.

Operating temperature °C	Safety factor SF	Permissible operating pressure bar	Minimum service life years
50	1.5	8.7	100
55	1.5	8.2	100
60	1.5	7.8	100
65	1.5	7.3	100
70	1.5	6.9	95
75	1.5	6.6	55
80	1.5	6.3	32
85	1.3	6.9	19
90	1.3	6.3	11
95	1.3	6.3	7

Tab. 03-2 Max. operating pressure and minimum service life at continuous temperature for REHAU SDR 11 PE-Xa district heating pipes according to DIN EN 15632

Factory-insulated flexible pipe systems with carrier pipes made of PE-Xa need to meet a minimum service life requirement in accordance with DIN EN 15632 to be used in district heating networks. This standard demands a minimum service life of 30 years and 100 h in a so-called load profile at a nominal pressure of 6 bar taking into account the respective safety factors and operating times at the respective temperatures.

	Safety factor	Temperature	Time
Operating temperature T _D	SF _D = 1.5	80 °C	29 years
Max. operating temperature T _{max}	SF _{max} = 1.3	90 °C	7760 h
		95 °C	1000 h
Malfunction temperature T _{mal}	SF _{mal} = 1.0	100 °C	100 h

Tab. 03-3 Load profile for district heating

The REHAU district heating PE-Xa carrier pipes are tested in accordance with the requirements of DIN EN 15632 and are independently certified by the IMA Dresden.

In the case of varying pressures and temperatures the expected service life can be calculated using the "Miner's rule" according to DIN 13760 in conjunction with DIN EN ISO 9080 (see "06.06 Service life calculation with the Miner's rule" on page 67).

You can also request the expected service life for a specified load profile from our REHAU technical department. Please get in touch with your REHAU contact person for more information.

03.01.02 District heating for increased pressure resistance: PE-Xa SDR 7.4 carrier pipe

In addition to the SDR 11 carrier pipes, the REHAU RAUTHERMEX system also features SDR 7.4 carrier pipes with thicker walls. The carrier pipes from the "RAUTHERMEX strong for district heating SDR 7.4" system have the same thermal stabilisation as the SDR 11 carrier pipes described in the Section 03.01.01. Their higher wall thickness, however, increases their pressure resistance. Such pipes are mainly used when larger elevation differences occur.

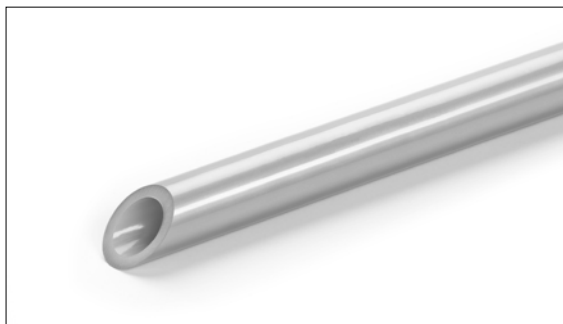

Fig. 03-3 SDR 7.4 carrier pipes: application – district heating

Information on temperature and pressure resistance is available upon request.



Fig. 03-4 RAUTHERMEX strong for district heating SDR 7.4

03.01.03 Drinking water: PE-Xa SDR 7.4 universal pipe RAUTITAN flex

The PE-Xa SDR 7.4 carrier pipe is used in many countries in a design approved for drinking water, for example, in a centralised domestic hot water supply in an open system. These pipes are different from the carrier pipes used in district heating in terms of their thermal stabilisation and their suitability for application in drinking water according to Section 03.01.01 and Section 03.01.02 and are specially designed for transporting drinking water/domestic hot water. They are used in the "RAUTHERMEX for plumbing SDR 7.4" system.

For the drinking water application, the standard requirements of DIN EN ISO 15875 apply that classify the use of the pipes in different application classes.

Application classes 1 and 2 apply to the supply of drinking water, whereby class 2 "Hot water supply (70 °C)" has higher requirement of temperature resistance. The standard demands the pipes to be durable for 50 years under the following operating conditions:

	Safety factor	Temperatures using the example of class 2	Time
Cold temperature T_{cold}	$SF_{cold} = 1.25$	–	–
Calculation temperature T_D	$SF_D = 1.5$	70 °C	49 years
Max. temperature T_{max}	$SF_{max} = 1.3$	80 °C	1 year
Malfunction temperature T_{mal}	$SF_{mal} = 1.0$	95 °C	100 h

Tab. 03-4 Load profile according to DIN EN ISO 15875 class 2



Fig. 03-5 RAUTHERMEX for plumbing SDR 7.4

The carrier pipes are certified in a system with the REHAU compression sleeve jointing technology in application class 2 according to DIN EN ISO 15875 up to a system pressure of 10 bar.

03.01.04 Continuous quality control

The quality of the REHAU carrier pipes is tested continuously by in-house accredited laboratories as well as external institutes.



Fig. 03-6 Point load test



Fig. 03-8 Burst pressure test



Fig. 03-7 Tensile test

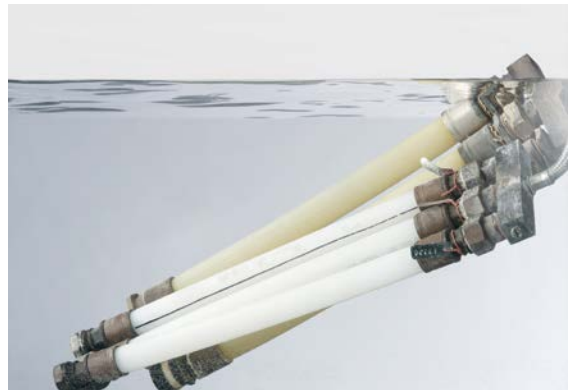

Fig. 03-9 Internal pressure creep test



03.02 RAUTHERMEX SDR 11/SDR 7.4



Fig. 03-10 RAUTHERMEX bonded pipe

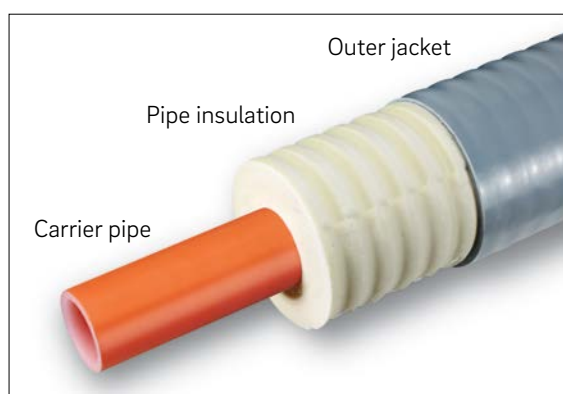

Fig. 03-11 RAUTHERMEX pipe – main components

03.02.01 Pipe insulation

The insulation of the RAUTHERMEX pipes consists of PU foam. For pipe coils, the insulation is continuous, for cut lengths and custom components intermittent. The PU foam is free from CFCs and HCFCs.

RAUTHERMEX ★

Thanks to the improved foam technology and foaming technology, the pipes in the RAUTHERMEX product range show an improvement of 7% to 8% in their thermal insulation properties compared to the previous version.

These pipes, which are made with the improved foaming technology, are marked with a ★ on the pipe outer jacket marking.

Technical data – pipe insulation

Property		RAUTHERMEX ★	RAUTHERMEX	RAUTHERMEX plumbing	Standard
Thermal conductivity $\lambda_{50, \text{initial}}$	W/m · K	≤ 0.0199	0.0260 for cut lengths and ready-made parts	≤ 0.0234	EN 15632
GWP (global warming potential)		1	0.5	1	–
ODP (ozone depletion potential)		0	0	0	–
Density ρ	kg/m ³	> 50	> 50	> 50	ISO 845
Resistance to pressure	MPa	0.15	0.2	0.3	ISO 844
Water absorption	%	≤ 10	≤ 10	≤ 10	EN 15632-1
Axial shear strength	kPa	≥ 90	≥ 90	≥ 90	EN 15632-2
Building material class		B2 (normal flammability)	B2 (normal flammability)	B2 (normal flammability)	DIN 4102

Tab. 03-5 Properties of pipe insulation RAUTHERMEX outer jacket

03.02.02 Outer jacket

RAUTHERMEX pipes have a corrugated outer jacket. The corrugation improves the structural properties, increases the flexibility and enables low bending radii. To increase the flexibility, the outer jacket of the RAUTHERMEX pipe is made from the flexible material PE-LLD.

For all pipes with an external diameter of 91–142, the corrugation of the outer jacket has been optimised with a greater wave height resulting in improved mechanical properties in terms of bending forces and bending radii.

Technical data – outer jacket

Designation	Value	Standard
Thermal conductivity λ	0.33 W/m·K	DIN 52612
Crystallite melting range	122 °C	ISO 11357-3
Density ρ	0.92 g/cm ³	ISO 1183
Modulus of elasticity E	325 N/mm ²	–
Building material class	B2 (normal flammability)	DIN 4102

Tab. 03-6 Properties of RAUTHERMEX outer jacket

03.02.03 Dimensions

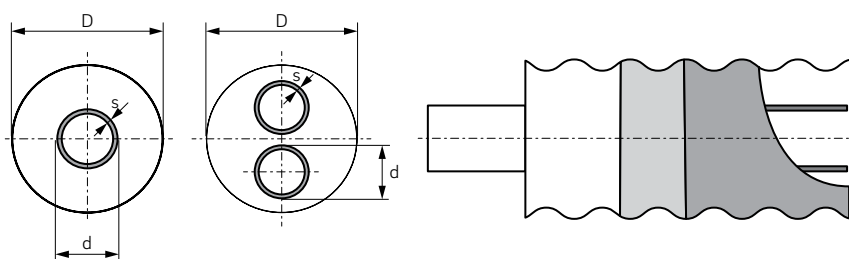

Fig. 03-12 RAUTHERMEX section

Type	d [mm]	s [mm]	D ²⁾ [mm]	Volume inner pipe [l/m]	Weight [kg/m]	Max. pipe coil length pipe coil Ø 2.8 m x 1.2 m [m]	RAUTHERMEX U-value ★ [W/m·K]
UNO 25/91	25	2.3	93	0.327	1.28	570	0.091
UNO 32/91	32	2.9	93	0.539	1.38	570	0.111
UNO 32/111 ¹⁾	32	2.9	113	0.539	1.69	400	0.096
UNO 40/91	40	3.7	93	0.835	1.48	570	0.138
UNO 40/126 ¹⁾	40	3.7	128	0.835	2.18	305	0.102
UNO 50/111	50	4.6	113	1.307	2.11	400	0.142
UNO 50/126 ¹⁾	50	4.6	128	1.307	2.64	305	0.126
UNO 63/126	63	5.8	128	2.075	2.86	305	0.162
UNO 63/142 ¹⁾	63	5.8	144	2.075	3.49	225	0.142
UNO 75/162	75	6.8	164	2.961	4.37	150	0.149
UNO 90/162	90	8.2	164	4.254	5.02	150	0.190
UNO 90/182 ¹⁾	90	8.2	185	4.254	5.61	86	0.162
UNO 110/162	110	10.0	164	6.362	5.78	150	0.274
UNO 110/182 ¹⁾	110	10.0	185	6.362	6.64	86	0.218
UNO 110/202 ¹⁾	110	10.0	206	6.362	7.29	75 ³⁾	0.186
UNO 125/182	125	11.4	185	8.203	7.20	86	0.281
UNO 125/202 ¹⁾	125	11.4	206	8.203	7.85	75 ³⁾	0.229
UNO 140/202	140	12.7	206	10.315	8.38	75 ³⁾	0.289
UNO 160/250	160	14.6	257	13.437	14.17	12 m cut lengths	0.303

Type	d	s	D ²⁾	Volume inner pipe	Weight	Max. pipe coil length pipe coil Ø 2.8 m x 1.2 m	RAUTHERMEX U-value ★
	[mm]	[mm]	[mm]	[l/m]	[kg/m]	[m]	[W/m·K]
DUO 20 + 20/111	20	1.9	113	2 x 0.206	1.50	400	0.107
DUO 25 + 25/111	25	2.3	113	2 x 0.327	1.85	400	0.129
DUO 32 + 32/111	32	2.9	113	2 x 0.539	2.11	400	0.169
DUO 32 + 32/126 ¹⁾	32	2.9	128	2 x 0.539	2.50	305	0.143
DUO 40 + 40/126	40	3.7	128	2 x 0.835	2.75	305	0.191
DUO 40 + 40/142 ¹⁾	40	3.7	144	2 x 0.835	3.32	225	0.159
DUO 50 + 50/162	50	4.6	164	2 x 1.307	4.25	150	0.178
DUO 50 + 50/182 ¹⁾	50	4.6	185	2 x 1.307	4.90	86	0.151
DUO 63 + 63/182	63	5.8	185	2 x 2.075	5.45	86	0.213
DUO 63 + 63/202 ¹⁾	63	5.8	206	2 x 2.075	5.90	75 ³⁾	0.178
DUO 75 + 75/202	75	6.8	206	2 x 2.961	6.70	75 ³⁾	0.243

¹⁾ Plus dimensions with higher insulation thickness.

²⁾ Maximum external diameter at the wave peak.

³⁾ If external diameter is 202 mm, the max. external diameter of the pipe coil is 2.9 m.

Tab. 03-7 Dimensions of RAUTHERMEX SDR 11

03.03 RAUVITHERM SDR 11



Fig. 03-13 RAUVITHERM pipe

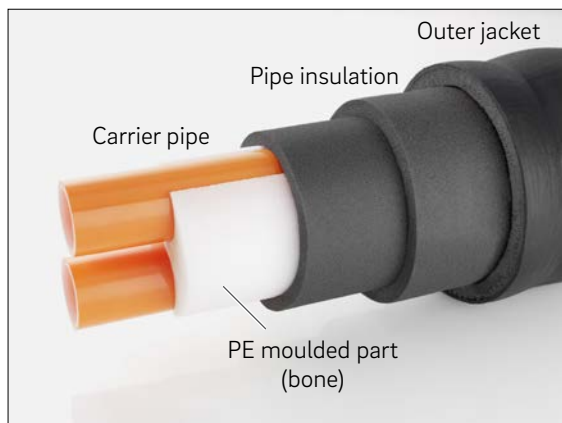

Fig. 03-14 RAUVITHERM pipe main components

03.03.01 Pipe insulation

The RAUVITHERM pipe SDR 11 is insulated with crosslinked PEX foam sheets and the DUO pipes additionally with a foamed PE moulded part (bones).



- Very fine-pored insulating foam structure
- Closed-cell factor $\geq 99\%$
- High water vapour transport coefficient

Technical data – pipe insulation

Designation	Value	Standard
Thermal conductivity $\lambda_{50, initial}$	$\leq 0.043-0.044$ W/m·K	EN 15632
Dense ρ insulating foam	≥ 30 kg/m ³	DIN 53420
Density ρ bone	≤ 45 kg/m ³	–
Compression hardness	0.073 N/mm ²	DIN 53577
Water absorption	$\leq 1\%$ Vol	DIN 53428
Long-term temperature resistance	≥ 95 °C	–

Tab. 03-8 Properties of RAUVITHERM pipe insulation

03.03.02 Outer jacket

The RAUVITHERM pipes have a corrugated outer jacket. The corrugation of the outer jacket improves the structural properties and the flexibility of the pipe.



- Extruded seamlessly on the PEX foam
- Highly robust, wall thickness ≥ 2 mm
- Fully bonded to DIN 15632-2

Technical data – outer jacket

Designation	Value	Standard
Thermal conductivity λ	0.09 W/m·K	DIN 52612
Crystallite melting range	125 °C	ISO 11357-3
Density ρ	0.65 g/cm ³	ISO 1183
Modulus of elasticity E	150 N/mm ²	–
Building material class	B2 (normal flammability)	DIN 4102

Tab. 03-9 Properties of RAUVITHERM outer jacket

03.03.03 Dimensions

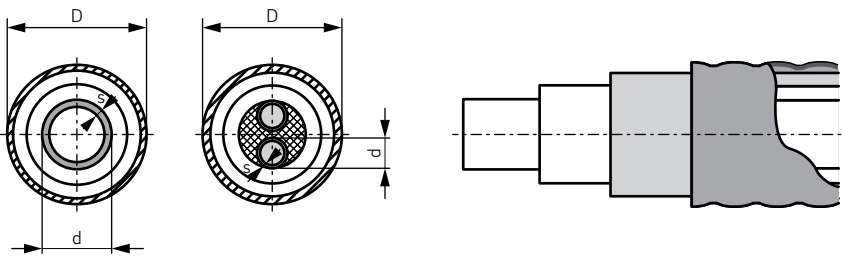

Fig. 03-15 RAUVITHERM section

Type	d [mm]	s [mm]	D [mm]	Volume inner pipe [l/m]	Weight [kg]	Wall thickness outer layer [mm]	Max. pipe coil length pipe coil \varnothing 3 m x 1.2 m [m]	U-value [W/m·K]
UNO 25/120	25	2.3	113	0.327	0.98	2.0	330	0.16
UNO 32/120	32	2.9	114	0.539	1.07	2.0	330	0.19
UNO 40/120	40	3.7	116	0.835	1.22	2.0	330	0.22
UNO 50/150	50	4.6	144	1.307	1.75	2.0	260	0.23
UNO 63/150	63	5.8	145	2.075	2.08	2.0	260	0.28
UNO 75/175	75	6.8	170	2.961	2.99	2.0	160	0.28
UNO 90/175	90	8.2	175	4.254	3.64	2.5	160	0.34
UNO 110/190	110	10.0	187	6.362	4.60	2.5	100	0.41
UNO 125/210	125	11.4	209	8.203	6.10	3.0	100	0.42
UNO 140/220	140	12.7	217	10.304	6.90	3.0	12	0.50
UNO160/240	160	14.6	237	13.437	9.30	3.0	12	0.55
DUO 25 + 25/150	25	2.3	144	2 x 0.327	1.66	2.0	260	0.25
DUO 32 + 32/150	32	2.9	146	2 x 0.539	1.87	2.0	260	0.26
DUO 40 + 40/150	40	3.7	148	2 x 0.835	2.24	2.0	260	0.32
DUO 50 + 50/175	50	4.6	177	2 x 1.307	3.31	2.5	160	0.34
DUO 63 + 63/210	63	5.8	208	2 x 2.075	4.77	3.0	100	0.38

Tab. 03-10 Dimensions of RAUVITHERM SDR 11

04 Jointing technology and secondary insulation

04.01 Compression sleeve jointing technology

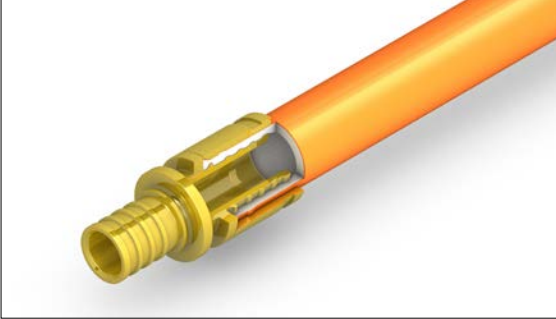

Fig. 04-1 Compression sleeve joint

The compression sleeve jointing technology is a method developed by REHAU and tried and tested over decades for the rapid, safe and permanently leaktight connection of PE-Xa pipes. It comprises simply a fitting and the compression sleeve. Additional sealing elements are not required, as the pipe itself acts as a seal. Four sealing ribs guarantee a completely secure connection, which also withstands the tough application conditions on construction sites. Specially designed ribs on the compression sleeves prevent the connection coming loose during operation.

The fittings are made from brass, red brass or steel. The compression sleeves are made from brass or red brass.



- Permanent connection on the construction site to AGFW FW420 that can be checked visually
- Practically no cross-section reduction, as carrier pipes are expanded to make the connection – pressure loss negligible as a result
- Quick and safe installation
- Can be pressurised immediately, no “tightening up” required
- Works under any weather conditions
- No additional sealing elements required, e.g. O-rings, hemp, etc.



Application options:

- Pressure level SDR 11 for the dimensions 20–160 mm
- Pressure level SDR 7.4 for the dimensions 20–63 mm

All of the fittings dimensions are listed in the current price list.



You will find the details about creating compression sleeve connections in the installation instructions at www.rehau.uk/districtheating.

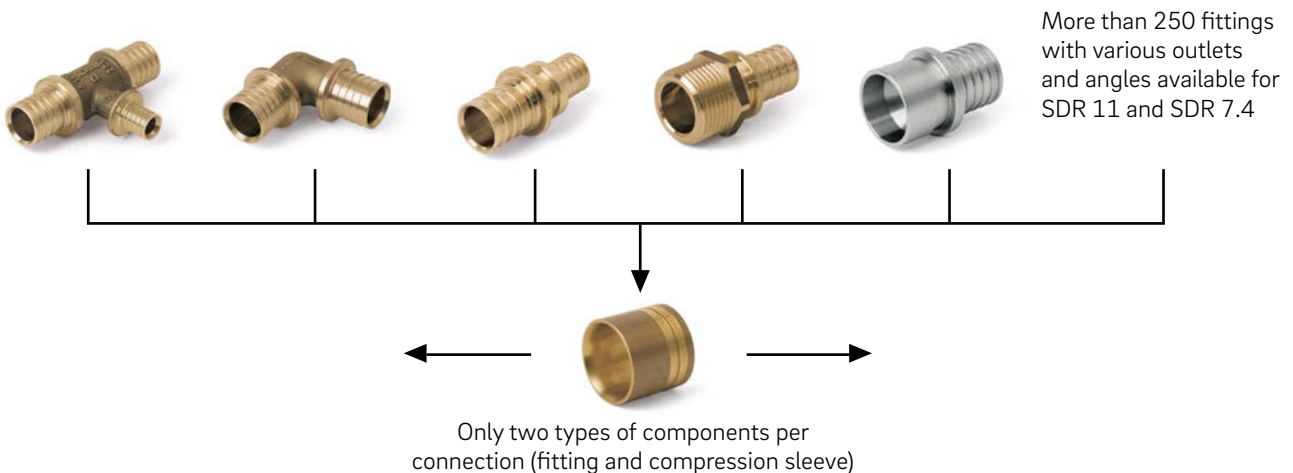

Fig. 04-2 Compression sleeve connection combinations

The REHAU compression sleeve jointing technology for water meets the highest demands in terms of connection quality and in particular the following requirements:

DVGW

- DVGW registration for pipe and jointing technology of (all dimensions).
- Permanently tight compression sleeve jointing technology in accordance with DIN EN 806, DIN 1988 and DVGW standard W 534 with DVGW registration.
- Suitable for areas of application with special hygiene requirements in accordance with DVGW standard W 270 (Microbial enhancement on materials to come into contact with drinking water).

DIN standards, laws, guidelines

- Universal pipes RAUTITAN Flex and the fittings RAUTITAN RX, RX+, LX and LX +G conform to the KTW guidelines (plastics and drinking water) of the German Environment Agency (Umweltbundesamt).
- RAUTITAN fittings used in the RAUTHERMEX plumbing system, which are intended for drinking water to flow through, are made of standard brass (system LX and LX +G) or red brass (RX or RX+). The RAUTITAN compression sleeve fittings supplied by REHAU for the drinking water installation conform to the currently valid version of DIN 50930-6 (Corrosion of metals – Corrosion of metallic materials under corrosion load by water inside of pipes, tanks and apparatus – Part 6: Influence of the composition of drinking water).



Fittings from the RAUTITAN PX range from PPSU or PVDF must not be used in the RAUTHERMEX plumbing pipes that are installed underground and/or have secondary insulation.

Drinking water requirements

The drinking water must comply with the currently valid limit values of the following rules and standards:

- DIN 2000
- German Drinking Water Ordinance ¹⁾
- European Union Council Directive 98/83/EC of 3 November 1998 on the quality of water intended for human consumption



The RAUTITAN LX fittings of REHAU in standard brass meet the requirements in accordance with DIN EN 1254-3. Nevertheless, it is generally considered that there is no ideal material for every application. Corrosion-inducing water qualities and certain mutual reactions within an installation (DIN EN 12502-1) can damage standard brass fittings.

1) The thresholds for maximum disinfectant concentrations specified in the Drinking Water Ordinance are not to be interpreted as permanent concentrations for continuous application. They represent the temporary maximum values defined under hygienic and toxicological aspects. The principle of minimisation in the Drinking Water Ordinance is extremely crucial, i.e. in principal, nothing is to be added to the water. Only if it is absolutely required to add a chemical in the case of contamination, the minimum required amount may be added.

Limitations of use of RAUTITAN LX and LX +G

The ratio of chloride and hydrogen carbonate contents can negatively influence the corrosiveness of water and cause a selective form of corrosion called "dezincification" in the RAUTITAN LX or LX +G fittings. In order to avoid corrosion effects when using RAUTITAN LX or LX +G in installations, the following maximum concentrations may not be exceeded:

- Chloride content (Cl_-) \leq 200 mg/l
- Sulphate content (SO_4^{2-}) \leq 250 mg/l
- Calcite solubility capacity calculated \leq 5 mg/l (met, as soon as pH value \geq 7.7)

In addition, the following Turner diagram (Fig. 04-4) is to be used to evaluate whether there are unfavourable water-side conditions.

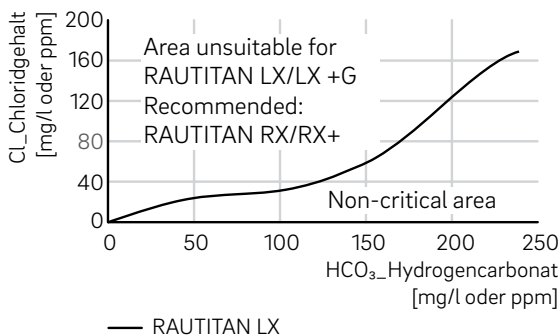

Fig. 04-3 Turner diagram
(source: Wieland Werke Deutschland)

In the case of water quality levels that are above the limit curve for RAUTITAN LX or local LX +G, dezincification must be anticipated. In this case, the RAUTITAN LX and LX +G fittings may not be used. The usability of alternative fitting materials is to be checked.

In such water supply areas, we recommend using the RAUTITAN RX or RX+ fittings in red brass.



The use of a water after-treatment system, such as water softening, will, in principle, lead to a change in the chemical corrosion behaviour of the water. To avoid corrosion damage due to incorrect use and operation of a water after-treatment system, we expressly recommend that you arrange for an expert, for example the system manufacturer, to check your individual situation in advance.

To evaluate the probability of corrosion, practical experience of the intended application area should also be called on for the distribution of the incoming water.

Within the area of responsibility of system planning, the factors and influencing variables mentioned above with regard to corrosion protection and stone formation for the specific application should be taken into consideration.

If necessary, our Technical Applications Department will provide assistance with the use of RAUTITAN.

If the quality of the water is outside the specifications of the regulations for drinking water, testing and approval by our Technical Applications Department will be required for installation of the RAUTITAN system.

Please contact your REHAU sales office about this.

RAUTOOL tools

The RAUTOOL tools from REHAU are available for making the REHAU compression sleeve connections. Depending on the area of application, manual, hydraulic or electrohydraulic designs are used:

RAUTOOL A light2 – battery hydraulic

Tool with battery-operated hydraulic unit (Fig. 04-4)

Range of application: Dimensions 20–40

RAUTOOL A-one – battery hydraulic

Tool with battery-operated hydraulic unit

Range of application: Dimensions 16–32

RAUTOOL A3 – battery hydraulic

Tool with battery-operated hydraulic unit

Range of application: Dimensions 20–40

RAUTOOL A5 – battery hydraulic

Tool with battery-operated hydraulic unit (Fig. 04-5)

Range of application: Dimensions 40–75

RAUTOOL G2 – electro-/battery hydraulic

Tool with hydraulic unit including Li-ion rechargeable battery and hydraulic hose (Fig. 04-6)

Range of application: Dimensions 50–63

Can be expanded up to dimension 40 as well as dimension 110 with the appropriate supplementary set

RAUTOOL G2 XL – electro-/battery hydraulic

Tool with hydraulic unit including Li-ion rechargeable battery and hydraulic hose (Fig. 04-7)

Range of application: Dimensions 120–160

With optional supplementary set of dimension 140

RAUTOOL Expand QC – electro-/battery hydraulic

Expander tool with battery-operated hydraulic device

Range of application: Dimensions 16–40

RAUTOOL Expand big – electro-/battery hydraulic

Expander tool with battery-operated hydraulic device

Range of application: Dimensions 40–75



Fig. 04-4 RAUTOOL A light2



Fig. 04-5 RAUTOOL A5



Fig. 04-6 RAUTOOL G2



Fig. 04-7 RAUTOOL G2 XL 125–160

04.02 FUSAPEX jointing technology



Fig. 04-8 FUSAPEX electrofusion couplers

The FUSAPEX electrofusion coupler is used for quick, easy and secure joining of RAUVITHERM and RAUTHERMEX SDR 11 carrier pipes for operating temperatures of -40 °C to +95 °C.



- Temperature-resistant from -40 °C to +95 °C
- Corrosion-resistant
- Cost effective
- Total plastic system
- Excellent chemical resistance
- Modular construction principle for the low-cost assembly of the required fittings depending on the requirements of the construction site
- Dimension range 50–160 SDR 11

The FUSAPEX jointing technology product range offers fittings for couplings, angles, reducers, flanges, threaded joints and branches.

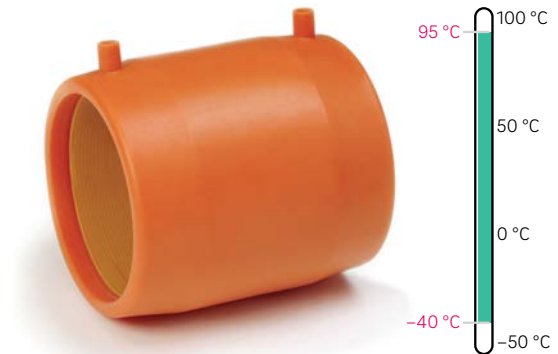

Fig. 04-9 FUSAPEX operating temperatures

The FUSAPEX electrofusion fittings are fittings with integrated resistance wire. By means of electric current, this wire is heated to the required fusion temperature at which fusion is carried out automatically. Each fitting has an integrated recognition resistor, which ensures the automatic setting of the welding parameters in the REHAU monomatic welding device.

FUSAPEX flange transitions and reducers are made from PE-Xa and can be used universally with FUSAPEX fittings with integrated heating coil.

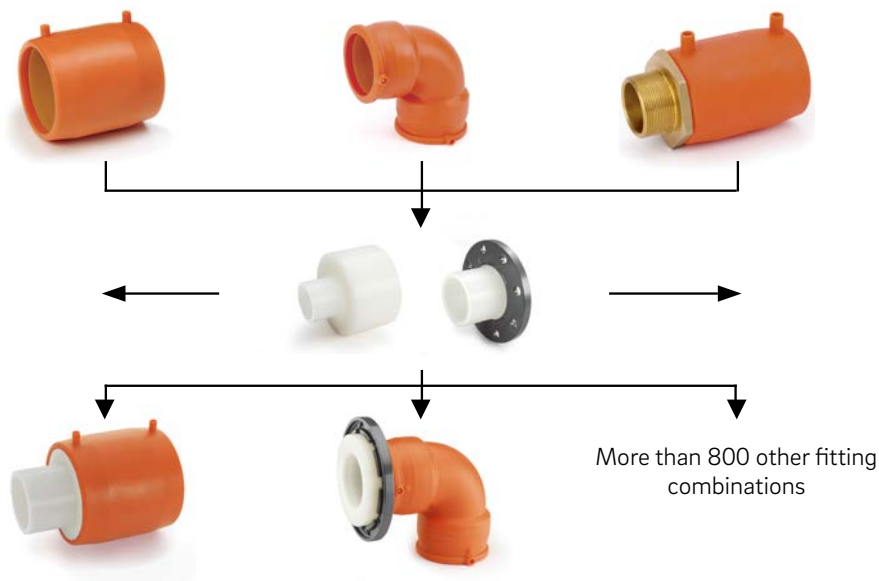

Fig. 04-10 FUSAPEX fitting combinations

FUSAPEX tool

To create a FUSAPEX joint the following is required:

- a fully automated monomatic welding device or SMARTFUSE 160 BT,
- universal pipe brackets,
- a rotational pipe scraper for removing the cover layer on the pipes; depending on the application or dimension of the pipes to be processed, two scrapers are available:
 - SMARTFUSE UNO (63–200 mm)
 - SMARTFUSE DUO (25–75 mm).

Additionally, Tangit special cleaning agent for PE (Tangit KS + Tangit cleaning wipes) and a manual pipe scraper are required.



Fig. 04-11 SMARTFUSE 160 BT, monomatic



Fig. 04-12 SMARTFUSE UNO 63–200 pipe scraper



Fig. 04-13 SMARTFUSE DUO 25–75 pipe scraper



You can find further information about FUSAPEX in the RAUPEX technical information which is available on www.rehau.uk/epaper.



FUSAPEX proof of training

A REHAU training course with a test at the end is required for installation of FUSAPEX electrofusion couplers. This training is generally carried out on site. Those completing the training course receive the FUSAPEX installer card with their personal identification number as proof of training.

The FUSAPEX installer card should always be carried when installing FUSAPEX. Immediately after the fusion process has been successfully completed, the FUSAPEX electrofusion fitting should be labelled with the installer's personal identification number and the current date.

To arrange a training date, please contact your local REHAU Sales Office.

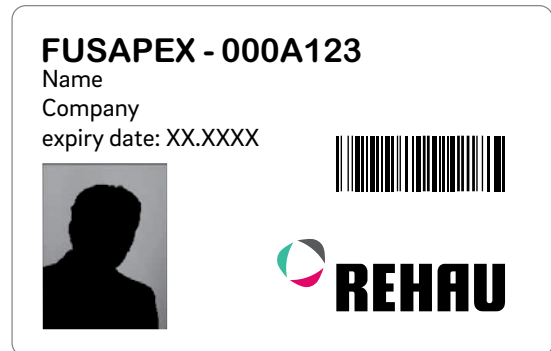

Fig. 04-14 FUSAPEX installer card

04.03 Screw/compression connections



Fig. 04-15 Example of screw/compression connector

Screw/compression connections for PE-Xa carrier pipes are easy-to-handle connection fittings. This jointing technology consists of a few individual components and can generally be fitted without special tools.

Screw/compression connections may only be used at connection points of heating pipes that are accessible at all times. As a rule, these are merely used for connecting pipes between two system components, since usually an access is possible only at those points.

Only screw/compression systems that have been approved by the respective manufacturer for the specific application of district heating must be used with the suitable assembly tool. Observe the respective installation instructions of the manufacturer.



After installing the screw/compression connections in hot water application, secure the connection by first heating up the heating pipe to 60–80 °C and then retightening all the screw-down nuts or flanges of the screw/compression connector. In later operation, these connections must be regularly checked and retightened if necessary.

In underground heat conduction sections, the PE-Xa carrier pipes must be connected through permanently leakproof connections such as the compression sleeve technology or FUSAPEX fusion connections in order to create permanent leakproof connections in accordance with the AGFW FW 420.

Non permanent jointing technologies such as screw or compression connectors are not suitable for belowground installation.

Tool for screw/compression connections

No special tools are required to fit screw/compression fittings.



Fig. 04-16 Installation tool

Example of use of screw/compression connections in combination with pre-insulated pipe systems in practice:

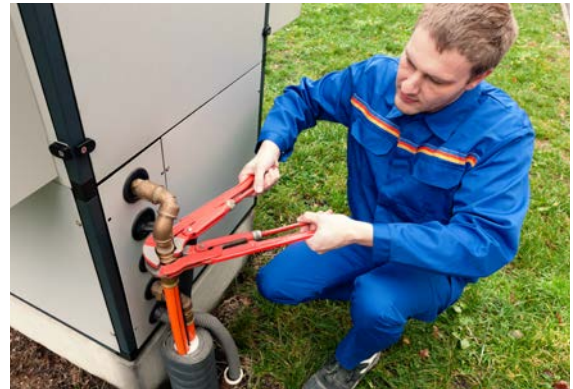

Fig. 04-17 Heat pump connection



- Installation possible without special tools
- non permanent jointing technology for fittings connections
- Temperature resistance depending on the manufacturer from –40 °C to +95 °C
- Suitable for various manufacturer-dependent dimensions SDR 11 as well as SDR 7.4

04.04 Clip shroud system for RAUTHERMEX



Fig. 04-18 Small clip shrouds in T, I and L shape

Underground joints, for example couplings or T-pipes, should have a secondary insulation and should be sealed to an insulation quality equivalent to that of the pipes.

The clip shrouds specially developed for RAUTHERMEX comprise two half shells that are placed over the carrier pipe connection and simply pressed together with tightening clips in accordance with the toggle lever principle. The seal between the shroud and the pipe is carried out by means of an innovative sealing ring concept. Grooves ensure the perfect positioning of the shroud. In addition to this, combined sealing and venting plugs ensure a quick and easy installation. A high-quality two-component PU foam in bottles is used for the secondary insulation (see Chapter 04.06).

Material properties of ABS

Yield stress	40 MPa
Tensile modulus	2200 MPa
Elongation at break	> 15%
Heat distortion temperature 1.8 MPa	94 °C
Flammability (UL 94; 1.6 mm)	HB

Tab. 04-1 Material properties of ABS



Fig. 04-19 Sealing rings for small clip shroud system

For sealing purposes, an innovative sealing ring concept made of EPDM (ethylene propylene diene monomer rubber) is used, which enables adjustment to the various pipe jacket diameters. An appropriately sized sealing ring is used for each of the individual pipe outlets.

Material properties of EPDM

Hardness Shore A	35 ± 5 Shore
Density	1.16 ± 0.02 g/cm ³
Tear resistance	8 MPa
Elongation at tear	600%
Compression set 22 h at 70 °C	0.18
Compression set 22 h at 100 °C	0.5

Tab. 04-2 Material properties of EPDM



Fig. 04-20 Large T-clip shroud, large sealing rings



You can find the installation instructions for creating clip shroud connections at www.rehau.uk/districtheating.



Fig. 04-21 Small T-clip shroud, angle deviation

The REHAU T, I and L clip shroud systems are watertight-tested up to 3 mWS, also at a maximum

angle deviations in the pipe installation of up to 20° for small shrouds and 10° for large shrouds (testing carried out in accordance with the additionally increased requirements of EN 489. Tested by MFPA Leipzig GmbH).



- Efficient and safe insulation of branches and connections to underground RAUTHERMEX heating pipes
- Practically tool-free installation
- Simple positioning of the half shells via track grooves
- Quick adjustment to pipe dimensions thanks to flexible sealing ring system
- Outer ribbing guarantees stability even in the event of large static loads
- Injection-moulded half shells made from high-quality ABS plastic

04.05 Heat-shrink shroud system for RAUVITHERM and RAUTHERMEX



Fig. 04-22 Heat-shrink shrouds in T, I and L shape

The universal heat-shrink shrouds ensure the secondary insulation of connections, branches and changes in direction of pipe systems RAUVITHERM and RAUTHERMEX.

The shrouds are made of extremely robust and impact-resistant PE-HD.



- Simple and safe sealing due to the tried and tested heat-shrink technology
- No increased heat loss
- Robust components suitable for construction sites
- Area of application includes RAUVITHERM, RAUTHERMEX as well as various pipe combinations and connections to other manufacturers' systems
- Can be used flexibly on site

The heat-shrink shrouds (see Fig. 04-22) are available as T, I and L mouldings in two sizes in each case.

Material properties of shrouds (PE-HD)

Thermal conductivity λ	0.43 W/m·K
Crystallite melting range	105–110 °C
Density ρ	0.93 N/mm ²
Modulus of elasticity E	600 N/mm ²
Construction material class (DIN 4102)	B2 (normal flammability)

Tab. 04-3 Material properties of heat-shrink shrouds

Heat-shrink sleeve for shroud set



Fig. 04-23 Heat-shrink T-shroud set

The heat-shrink sleeve seals the shroud to the pre-insulated pipe. It is coated inside with a hot-melt adhesive to enable a secure and permanent seal.

Material properties of heat-shrink sleeves

Tensile strength	14 MPa
Max. expansion	300%
Density ρ	1.1 g/cm ³
Water absorption	< 0.1%
Adhesive softening temperature	80–90 °C
Construction material class (DIN 4102)	B2 (normal flammability)

Tab. 04-4 Material properties of heat-shrink sleeves

REHAU heat-shrinkable shrouds can be used universally. They can be used for connecting RAUVITHERM and RAUTHERMEX pipes as well as for combinations with various other pipe systems or custom components.



Fig. 04-24 Fitting the heat-shrink T-shroud



You can find the installation instructions for heat-shrink shrouds at www.rehau.uk/districtheating.

The further development of the heat-shrink shroud range T, I and L including the heat-shrink sleeve technology enables angle deviations (α) of up to 20° for all sizes and shapes. This is tested and certified by the MFPA Leipzig for up to 5 m of water column.



Fig. 04-25 Angle deviations



04.06 Shroud foam for secondary insulation



Fig. 04-26 REHAU shroud foam

The insulation of the REHAU shrouds is made from two-component PU foam.

The foam is supplied with the set and comprises:

- Foam bottle component A + B
- Filler attachment
- Installation instructions



Prior to using the foam products, you must read the enclosed installation instructions carefully. During installation, the appropriate personal protective equipment is to be worn. Safety data sheets on the foam components can be obtained from your REHAU contact person upon request.



Fig. 04-27 Shroud filling process



In order to avoid a burst risk and achieve proper foaming of the shroud:

Ensure that the temperature of the foam components is between 15 and 25 °C during processing.

If necessary, the foam components must be brought up to temperature beforehand.

Observe the shaking and processing time in accordance with the specifications in the installation instructions.

The components must be mixed in the immediate vicinity of the shroud to be processed, and the subsequent work steps are to be carried out immediately afterwards.

04.07 Custom accessories

04.07.01 REHAU NEXUS



Fig. 04-28 REHAU NEXUS live tapping saddle

The REHAU NEXUS live tapping saddle is used for quick, easy and secure teeing off from RAUTHERMEX or RAUVITHERM during operation, at operating temperatures and maximum operating pressures according to DIN 16892/93 and DIN EN 15632 (cf. Chapter 03).

The tapping saddle is available in the following dimensions of the carrier pipe of the REHAU pipe systems RAUVITHERM and RAUTHERMEX: 63 mm, 75 mm, 90 mm, 110 mm, 125 mm SDR 11



- Easy and secure network extension on live system under pressure and at temperature
- No elaborate construction site preparations
- No draining of the network
- No excavation of large trench lengths or squeezing of the pipes
- Comprehensive functionality, e.g. through the retrospective installation of intelligent measuring points
- Network extension possible without decommissioning the network or subnetwork
- The NEXUS drilling system is type-tested by TÜV Süd and approved for the two pipe systems RAUTHERMEX and RAUVITHERM.

The NEXUS live tapping saddle is fitted with a compression sleeve branch and the following carrier pipe dimensions can be achieved on the branch:

External Ø of carrier pipe mm	Wall thickness mm	Series of dimension
25	2.3	SDR 11
32	2.9	SDR 11
40	3.7	SDR 11

Tab. 04-5 Carrier pipe dimensions at the branch

For in-house installation there is also the option of supplying the branch with a universal adapter (1" internal thread).

Programme components

Tapping bridge

The cast-iron tapping saddle can be connected to carrier pipes with external dimensions of 63 to 125 mm. It consists of screwing the connecting and retaining pipe around the pipe

- for PE-Xa carrier pipes, available with pipe nominal diameters of d 63 to d 125
- GGG connecting and retaining pipe with red high-temperature resistant coating
- Hot-water resistant silicone seal
- The installation is independent of weather conditions at ambient temperatures > 5 °C

Ball valve for side tapping

The ball valve with a stainless-steel shut-off ball and Teflon sealing is used for operational and auxiliary shut-off. The connection between the connecting pipe and the tapping valve is a special feature of the REHAU NEXUS live tapping saddle. All tapping saddles are sealed with an O-ring seal as well as a special three-dimensional silicone gasket. The housing and the upper part are made of silicon brass.

Brass pipe insert

Following the tapping under pressure, a second installation process is carried out where, with the help of the insert fixing tool, the pipe insert is screwed through the saddle into the borehole in the pipe wall and thus extends the axle of the tapping saddle up into the pipe. It therefore prevents the installed tapping saddle from being rotated or moved on the main pipe as well as the pipe material collapsing around the borehole.

Pipe insert details:

- Insert cuts with tapered thread into the borehole of the PE-Xa pipe
- Welding work is not necessary; the installation is independent of weather conditions
- Easy installation under pressure with the corresponding borehole insert fixing tool
- System component of the REHAU NEXUS live tapping saddle

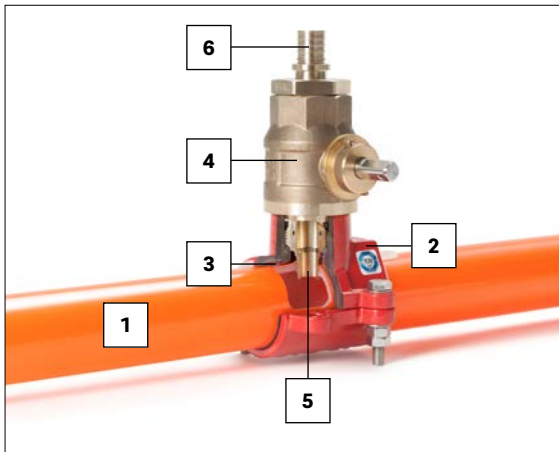

Fig. 04-29 Nexus section

- 1 Pipe
- 2 Tapping bridge (saddle)
- 3 Silicone seal
- 4 Ball valve
- 5 Pipe insert
- 6 Compression sleeve adapter

REHAU NEXUS tool set

The tapping tools are an integrated part of the tapping system and enable the tapping under pressure. The borehole insert fixing tool is designed similarly to the tapping tool and enables the required borehole pipe insert to be used during the mains operation.



Fig. 04-30 REHAU NEXUS tool set

Other tools for operating the tapping saddle, such as operating keys, adapter fittings, replacement drills and pressure testing equipment, complete the range of accessories.

Joining technology and secondary insulation

RAUTHERMEX/RAUVITHERM – Compression sleeve connection

To connect the branch pipe to the tapping saddle, a compression sleeve adapter is used, which is screwed into the fitting and additionally glued for below ground installations. On the pipe side, the connection to the adapter is made with REHAU compression tool RAUTOOL.

REHAU NEXUS secondary insulation

REHAU offers "REHAU heat-shrink T-shroud set – large", shrink collars and the REHAU shroud foam for insulation of the retrofitted connection. Heat-shrink sleeves cannot be retrofitted on the existing main pipe. The heat-shrink shroud is therefore shrunk with additional heat shrink sleeves.

Universal adapter

For the in-house installation, e.g. for installation of a measuring valve, a venting option or a bypass, a universal adapter with 1" internal thread is available instead of the compression sleeve adapter for connecting a pipe or a device.



REHAU NEXUS proof of training

It is mandatory to complete a REHAU training course with a test at the end to install the REHAU NEXUS live tapping saddle. Those completing the training course receive the REHAU NEXUS installer card with their personal identification number as proof of training.

The REHAU NEXUS installer card should always be carried when installing NEXUS. Immediately after the connection has been successfully completed in an existing network pipe, the REHAU NEXUS live tapping saddle should be labelled with the installer's personal identification number and the current date.

To arrange a training date, please contact your local REHAU Sales Office.

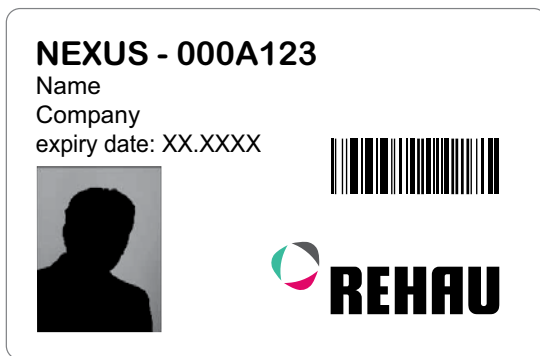

Fig. 04-31 NEXUS installer card

04.07.02 Y-pipe

The prefabricated Y-pipe component is used as a transition from two UNO pipes to one DUO pipe.

The Y-pipe is available for the dimensions 25 to 75 mm and can be used for both RAUVITHERM and RAUTHERMEX.

Properties:

- Carrier pipe made of cross-linked polyethylene (PE-Xa) to DIN EN 15632 and an oxygen diffusion barrier to DIN 4726
- Insulation made from CFC-free, pentane-blown rigid foam
- Smooth pipe jacket made from PE-HD, colour black
- Outer jacket made up of segments produced by means of butt welding

Installation Information

The connection of carrier pipes of the Y-pipe to the pipes generally takes place using the compression sleeve technology.

The connection of the outer jacket can either be carried out with the REHAU clip shroud system or heat-shrink shroud system. For easier installation and subsequent backfilling of the pipe trench it is recommended to install Y-pipes with spacing of ≥ 2 m at the necessary points (e.g. T-branches).



In order to ensure proper backfilling and compacting, the Y-pipe is to be installed predominantly horizontally. The allocation of the flow and return must be checked prior to installation and observed during installation.



Fig. 04-32 Y-pipe

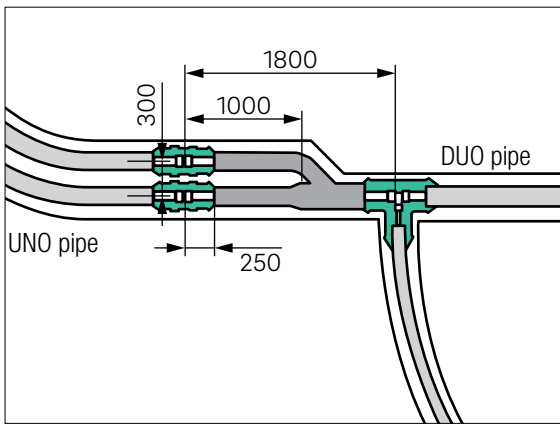

Fig. 04-33 Dimensions of Y-pipe



Fig. 04-34 Y-pipe installation in practice

Installation example

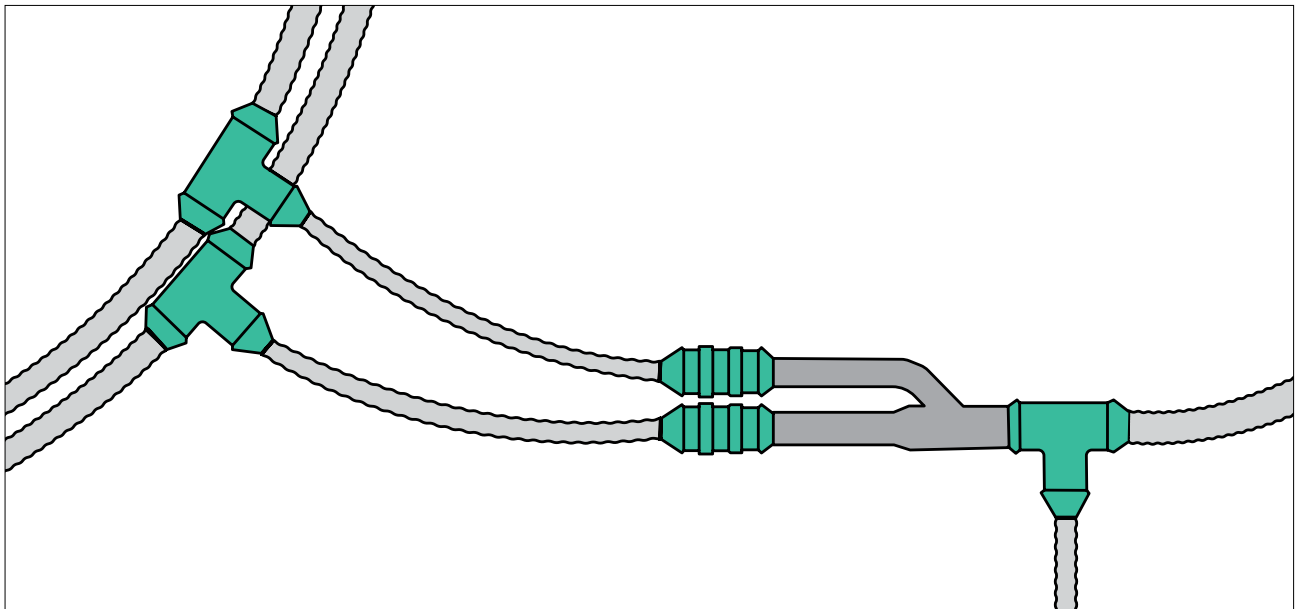

Fig. 04-35 Installation diagram/components for a branch with Y-pipe connection (top view)

04.07.03 Pre-insulated shut-off valve



Fig. 04-36 UNO shut-off valve with spindle extension and key

The pre-insulated, very compact REHAU shut-off valves with ball valve have a hexagonal connection for a spindle extension (1 m) and a hexagonal key. Compression sleeve adapters are installed in the factory for the connection with RAUVITHERM or RAUTHERMEX (SDR 11 in each case). The required compression sleeves are included in the scope of supply.



The connection to pipes takes place using I-shrouds or reducing sleeves. When doing this, the external diameter of the pipe jacket according to Tab. 04-7 must be observed.

Materials

Shut-off valve	Steel S 235 JR
Insulation material	PU foam
Outer jacket	PE-HD, smooth

Tab. 04-6 Shut-off valve materials

Installation and maintenance information

In the case of DUO shut-off valves, the position of the carrier pipes is not vertical but diagonally offset, so the component remains compact.

The position must be aligned with the pipe feed line. For easy installation, spacing of ≥ 3 m at the necessary points (e.g. branches) must be observed. The main pipe must then be twisted upstream and downstream of the shut-off valve.



To retain the function in the long-term, the valve must be exercised fully at least once every 6 months.

The factory-assembled weld-on ends on both sides enable a connection to the pipe systems RAUVITHERM and RAUTHERMEX.

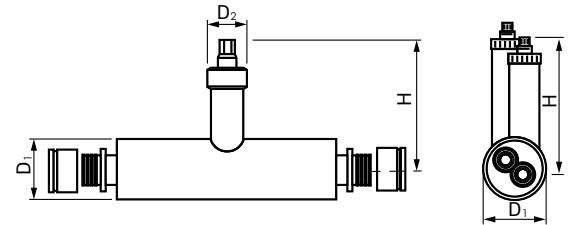

Fig. 04-37 Sketch of the UNO/DUO shut-off valve

Valve dimension	$\varnothing D_1$ pipe jacket [mm]	Height H [mm]	$\varnothing D_2$ [mm]	SW Hexagonal [mm]
UNO 25	110	475	110	19
UNO 32	110	480	110	19
UNO 40	125	485	110	19
UNO 50	125	495	110	19
UNO 63	140	500	110	19
UNO 75	160	505	110	19
UNO 90	180	515	110	19
UNO 110	225	525	125	27
UNO 125	250	545	125	27
DUO 25	140	475	110	19
DUO 32	140	480	110	19
DUO 40	160	485	110	19
DUO 50	180	495	110	19
DUO 63	225	500	110	19
DUO 75	250	505	110	19

Tab. 04-7 Dimensions of shut-off valves

Installation diagram of pre-insulated shut-off valve

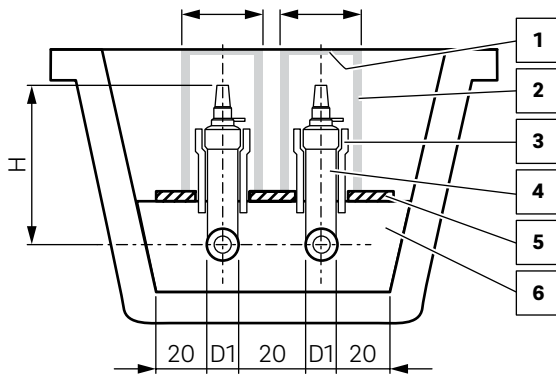

Fig. 04-38 Installation diagram of pre-insulated shut-off valve

- 1 Cast lid, can be driven over (construction site)
- 2 Concrete pipe (construction site)
- 3 Expansion bellow (construction site)
- 4 Shut-off valve
- 5 Supporting plate (construction site)
- 6 Sand filler, grain size 0–4 mm

04.07.04 Pre-insulated T-branches 125–160 (steel)

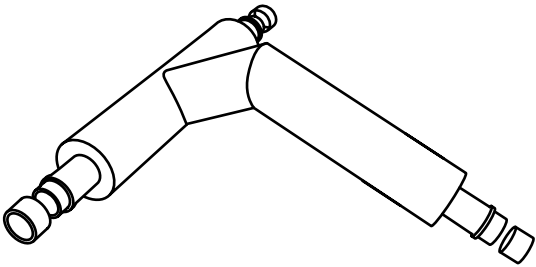

Fig. 04-39 Pre-insulated T-branch

The pre-insulated SDR 11 steel T-pipes from REHAU are supplied in offset version.

The connecting fittings are pre-assembled in the factory and the compression sleeves are included in the scope of supply.

Depending on the required dimension d 25– d 160, the outlet can be fabricated on request.

The available branch dimensions can be found in Tab. 04-9.

Materials

T-pipe	Steel St 37
Insulation material	PU foam
Outer jacket	PE-HD, smooth
Compression sleeve dim. 25–63	Brass
Compression sleeve dim. 75–160	Red brass Rg 7

Tab. 04-8 Pre-insulated T-pipe materials



Connections to pipelines are made using heat-shrink I-shrouds (d 25– d 140) or using a custom dimension connection sleeve set (d 160).

Design options in pre-insulated T-branch

Dimensions branch	Any clearance		
	125/200	140/225	160/250
25/90	x	x	x
32/90	x	x	x
40/90	x	x	x
50/110	x	x	x
63/125	x	x	x
75/160	x	x	x
90/160	x	x	x
110/160	x	x	x
110/180	x	x	x
125/180	x	x	x
140/225	–	x	x
160/250	–	–	x

Tab. 04-9 Design options in pre-insulated T-branch

05 Building connection and wall entry



Image credit: Naturstrom AG



Heat source/energy centre



Fig. 05-1 Energy centre

The starting point of each heat network is the energy centre, in which the heat is generated or is available elsewhere in the form of waste heat (for example from an industrial process).

The heat to be distributed is mostly transferred using a heat exchanger or buffer store. Usually, the heat network is supplied with flow temperatures of approx. 60–80 °C.



Heat transfer/house connection

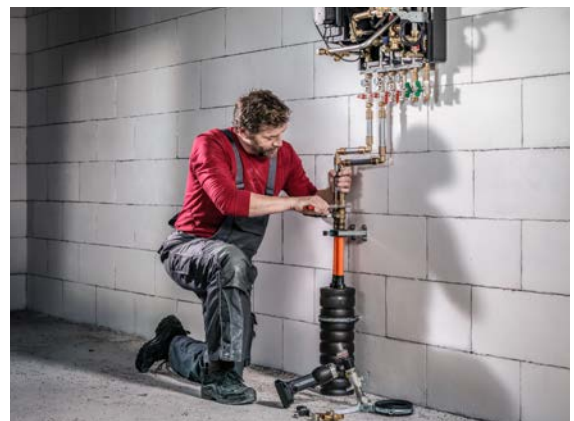

Fig. 05-2 Transfer point

Consumer connections typically terminate at heat interface units (HIU), with which the heat is transferred to the building's internal pipe heating system.

Once the required amount of heat has been extracted, the cooler heating medium is transported back to the energy centre at approx. 40–60 °C. A closed loop is created.

05.01 Wall penetrations



Fig. 05-3 Wall seal/labyrinth seal

Wall seals are used to seal pipe inlets against the wall for ground water pressures up to 0.2 bar. They are available for both RAUVITHERM and RAUTHERMEX.



For RAUVITHERM pipes, butyl tape must additionally be applied in the contact area of the wall seal on the pipe.

Installation information

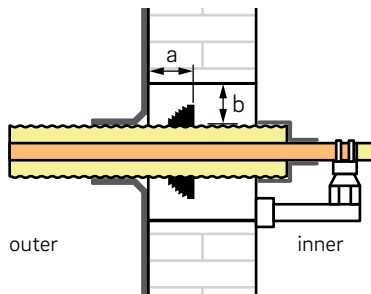

Fig. 05-4 Cross-section of wall duct in wall penetration

- The higher end of the wall seal must face towards the inside of the building and the sloped, stepped end must face outward.
- Sealing is carried out using conventional expanding mortar. The expanding mortar must increase in volume. Non-shrink grouting mortar is not suitable.
- For a proper backfilling, spacing of approx. 80 mm for the distances a and b must be maintained for wall penetrations. Depending on the expanding mortar used, you can also reduce the annular gap (b). Observe the manufacturer's specifications.
- The minimum necessary diameter of the wall penetration is shown in Tab. 05-1. In free-flowing expanding mortar variants, the clear distance of the pipes to the wall can also vary, and you may select a smaller size of the penetration.
- Any cavities in the masonry must be closed before

applying the expanding mortar.

- It is necessary to ensure that the complete wall seal is properly filled. In doing so, the current state of the art and the adherence to the manufacturer's specifications of the expanding mortar must be observed.

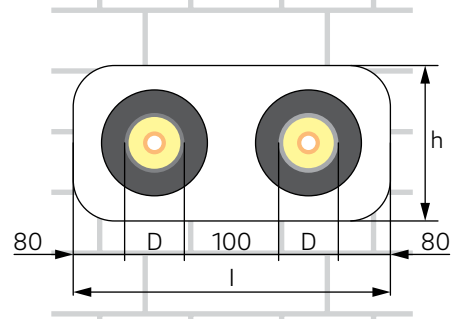

Fig. 05-5 Dimensions of wall penetration

External diameter of pipe jacket D [mm]	Wall penetration for 1 pipe approx. h x l [mm]	Wall penetration for 2 pipes approx. h x l [mm]
91	250 x 250 ¹⁾	250 x 450 ¹⁾
111	275 x 275 ¹⁾	275 x 500 ¹⁾
120	300 x 300 ¹⁾	300 x 550 ¹⁾
126	300 x 300 ¹⁾	300 x 550 ¹⁾
142	325 x 325 ¹⁾	325 x 600 ¹⁾
150	325 x 325 ¹⁾	325 x 600 ¹⁾
162	325 x 325 ¹⁾	325 x 600 ¹⁾
175	350 x 350 ¹⁾	350 x 650 ¹⁾
182	350 x 350 ¹⁾	350 x 650 ¹⁾
190	350 x 350 ¹⁾	350 x 650 ¹⁾
202	375 x 375 ¹⁾	375 x 700 ¹⁾
210	375 x 375 ¹⁾	375 x 700 ¹⁾
250	400 x 400 ¹⁾	400 x 750 ¹⁾

¹⁾ Depending on the expanding mortar used, the size of the penetration can also be reduced. Observe the manufacturer's specifications.

Tab. 05-1 Wall penetration dimensions

05.02 Core drill holes

05.02.01 Wall seal and expanding mortar

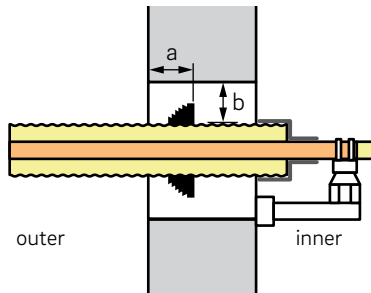

Fig. 05-6 Cross-section wall duct in core drill hole

With this method, wall penetrations with both RAUVITHERM pipes as well as RAUTHERMEX pipes can be made using core drill holes with all seals.



For RAUVITHERM pipes, butyl tape must additionally be applied in the contact area of the wall seal on the pipe.

Installation instructions and dimensions for core drill hole

- The higher end of the wall seal must face towards the inside of the building and the sloped, stepped end must face outward.
- Sealing is carried out using conventional expanding mortar. The expanding mortar must increase in volume. Non-shrink grouting mortar is not suitable.
- For a proper backfilling, spacing of approx. 80 mm for the distances a and b must be maintained for wall penetrations. Depending on the expanding mortar used, you can also reduce the annular gap (b). Observe the manufacturer's specifications.
- The minimum necessary diameter of the wall penetration is shown in Tab. 05-2. In free-flowing expanding mortar variants, the clear distance of the pipes to the wall can also vary, and you may select a smaller size of the penetration.
- Any cavities in the masonry must be closed before applying the expanding mortar.
- It is necessary to ensure that the complete wall seal is properly embedded. In doing so, the current state of the art and the adherence to the manufacturer's specifications of the expanding mortar must be observed.

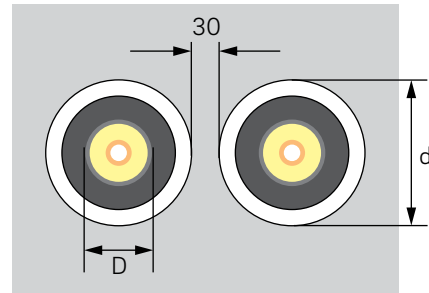

Fig. 05-7 Dimensions of core drill hole

External diameter of pipe jacket D [mm]	Minimum diameter of core drill hole d [mm]
91–111	250 ¹⁾
120–150	300 ¹⁾
162–190	350 ¹⁾
202–250	400 ¹⁾

¹⁾ Depending on the expanding mortar used, you can also reduce the annular gap (b). Observe the manufacturer's specifications.

Tab. 05-2 Core drill hole diameters

05.02.02 Sealing flange



Fig. 05-8 Sealing flange

Ducts for RAUTHERMEX pipes through concrete walls/components can be sealed using the sealing flange. Sealing is carried out in core drill holes or casing pipes/masonry sleeves made of plastic or fibre cement.



The sealing flange must only be used for RAUTHERMEX pipes.

Installation instructions and dimensions of core drill hole

- In the case of several ducts next to each other, the distance between the core drill holes or casing pipes should be at least 30 mm.
- The RAUTHERMEX pipes must have a maximum angular deviation of 7° in the borehole.
- For a stress-free entry, increase the minimum bending radii specified in Tab. 07-4 or Tab. 07-5 on page 78 in the area of the wall entry by the factor of 2.5.
- The position of the pipe in the casing pipe or in the core drill hole must be secured.
- The sealing flange must always be installed stress-free as it does not serve as bearing.

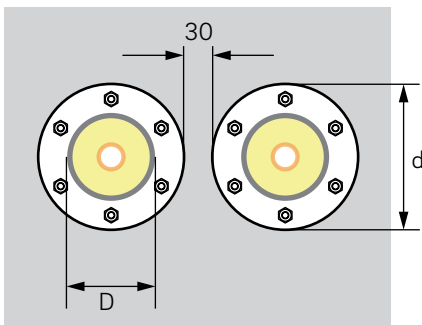

Fig. 05-9 Distance of core drill hole

External diameter of pipe jacket D [mm]	Core drill hole diameter d [mm]
91	150 ± 2
111–142	200 ± 2
162–182	250 ± 2
202	300 ± 2
250	350 ± 2

Tab. 05-3 Core drill hole diameters



Prior to installing the sealing flange, core drill holes must be sealed with REHAU borehole preserver.

05.02.02.01 RAUTHERMEX wall sealing flange FA 80

Use:

As a sealing through concrete and in the casing pipe through masonry in the case of pressing water, up to 15 m of water column in combination with RAUTHERMEX.

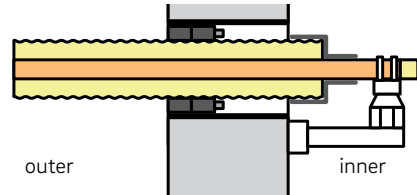

Fig. 05-10 Sealing flange FA 80



The sealing flange should seal flush against the outside of the wall. It must be prevented from protruding out of the outside wall.

05.02.02.02 RAUTHERMEX wall sealing flange FA 40

Use:

- For centering the pipes in the casing or the core drill hole.
- As a sealing through concrete and in the casing pipe through masonry in the case of pressing water, up to 5 m of water column in combination with RAUTHERMEX pipes for external diameter of 162–250 mm

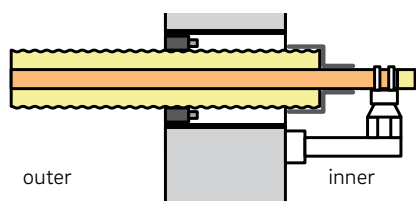

Fig. 05-11 Sealing flange FA 40



The sealing flange should seal flush against the outside of the wall. It must be prevented from protruding out of the outside wall.

05.02.02.03 Installation information sealing flange



Fig. 05-12 Installation using a torque wrench



In order for the seal to be retightened during operation, the nuts of the seal must face towards the inside of the building.

External diameter of RAUTHERMEX	Screws	Width across flats [mm]	Starting torque [nm]
91	M 6	10	5
111–142	M 8	13	10
162–182	M 8	13	10
202	M 8	13	10
250	M 8	13	10

Tab. 05-4 Screws, wrench size and starting torque

05.03 Sealing with roughened pipe insert

For sealing RAUVITHERM or RAUTHERMEX in wall penetrations, a PVC pipe insert with roughened surface and heat-shrink sleeve can also be used. The pipe insert is suitable for direct installation with expanding mortar or for encasing in concrete. The system is water-tight up to 2 m of water column.

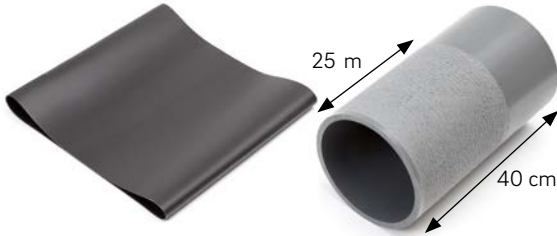

Fig. 05-13 Pipe insert (roughened surface)

Dimensions RAUVITHERM/ RAUTHERMEX		Sleeve diameter	
UNO	DUO	Outer [mm]	Inner [mm]
25-40	-	160	143
50-90	25-50	225	202
110-125	63	280	252

Tab. 05-5 Diameter of the wall opening for pipe inserts with roughened surface

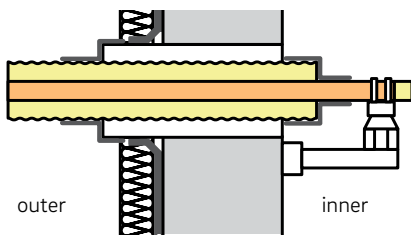

Fig. 05-14 Installation diagram for pipe insert with roughened surface



Pipe entries possible with an angle of up to 20° between the pipe and the sleeve

05.04 Sealing with REHAU wall entry set

For installation of RAUVITHERM or RAUTHERMEX in core drill holes, you can also use the REHAU wall entry set with a heat-shrink sleeve and a link chain seal.



Fig. 05-15 Wall entry set with heat-shrink sleeve and link chain seal

Pipe outer jacket diameter [mm]	Core drill hole diameter [mm]
up to 150	200 ± 2
up to 210	300 ± 2

Tab. 05-6 Core drill hole diameter for wall entry set with heat-shrink shroud and link chain seal



Fig. 05-16 Installation example of a wall entry set with heat-shrink sleeve and link chain seal

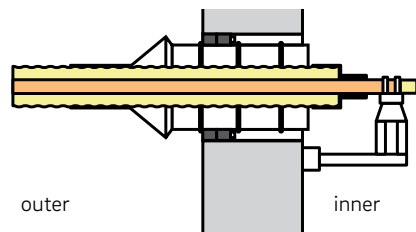

Fig. 05-17 Installation diagram of wall entry set with heat-shrink sleeve and link chain seal



Pipe entries possible with an angle of up to 20° between the pipe and the sleeve

05.05 Building entries

05.05.01 Prefabricated lead-in bend (rigid)



Fig. 05-18 Prefabricated lead-in bends UNO and DUO

The REHAU prefabricated lead-in bends enable the creation of stress-free wall entries with a 90 degree change in pipe direction. This is usually the case when installing pipes going into a building with no basement.

The prefabricated lead-in bends are available in the dimensions 25–160 (UNO) and 25–75 (DUO). They can be used for RAUVITHERM and RAUTHERMEX.

Dimensions and materials

The leg length is 1.60 m x 1.10 m.

Component	Material
Carrier pipe	Cross-linked polyethylene (PE-Xa)
Insulation material	CFC-free PU foam
Outer jacket	Polyethylene PE-HD, smooth
Angle	Made up of segments produced by means of butt welding

Tab. 05-7 Materials of prefabricated lead-in bend

Installation

1. Fit the wall seal and position the prefabricated lead-in bends below ground.
2. Fix the vertical leg.
3. Cast the ground slab/foundation.
4. Connect other pipes using the standard I-shroud connection.

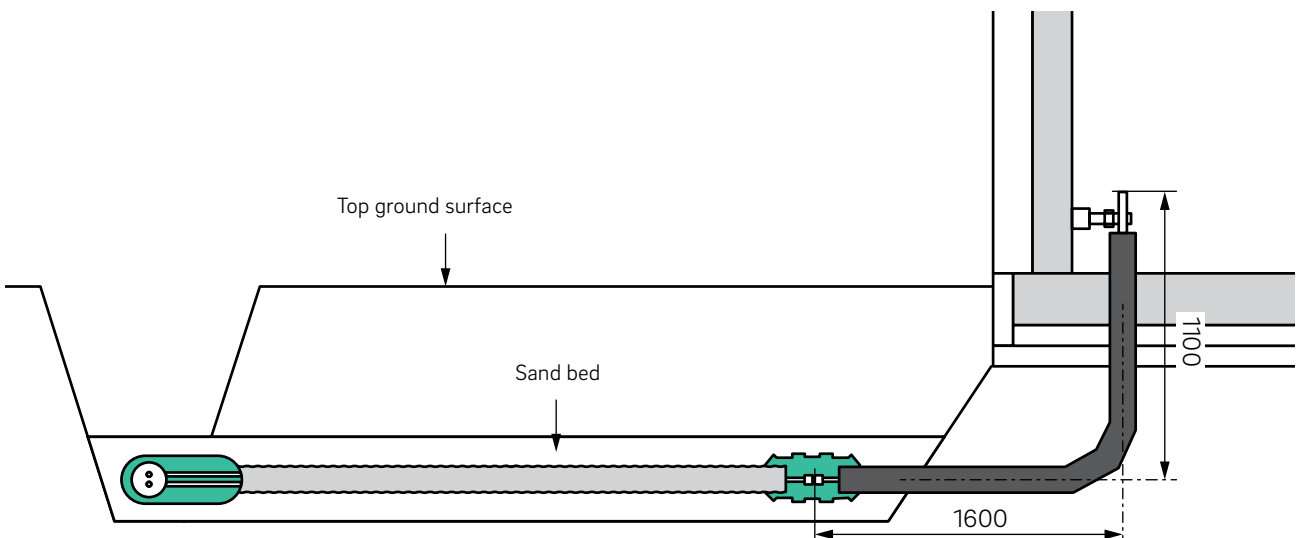

Fig. 05-19 Dimensions of prefabricated lead-in bend (rigid)

Venting of capped off pipes

If, for example, pipelines are pre-laid at T-branches for a future house connection and are capped off, this section of the pipe should be laid downwards away from the T-piece with a slight slope of approx. 2–3%, so that trapped air can escape to the main pipe when filling the pipe or commissioning.

05.05.02 Duct assisted building entries



Fig. 05-20 Building entry in a duct in case of buildings with no basement

For a reversible building connection to a heat network, particularly in the case of buildings with no basement, we recommend running the pipe in a duct into the building.

The vertical pipe section h must be so long that it extends from the bottom edge of the ground slab to a minimum of 5 cm above. Use a wall seal for watertight integration of duct against the concrete slab.

A shroud end must be installed at the top so that a wall sealing flange can be used on the top end of the pipe to seal the annular gap air-tight.

Use 15° elbows ducts to create the 90 degree bend.

The horizontal duct section must be long enough so that its end is freely accessible from the outside after completion of the ground slab and so that it lies outside the load-bearing area of the foundation. If required, also take into account the installation surfaces for scaffolding, so that the route can be overlaid with the district heating pipe from the outside during any construction phase. Also note that DUO pipes in the pipeline trench run with carrier pipes laid on top of each other. However, the pipes twist at vertical bends so that the carrier pipes lie adjacent to one another. Therefore, there must be sufficient free pipe length (at least 3 m depending on dimension) before the vertical bend, so that the pre-insulated pipe can twist up to 90°.

The transition between the pipe and the duct is sealed externally using a heat-shrink sleeve.

The annular gap must be adequately dimensioned, so that the pipe can be pulled in. Depending on the pipe dimension, leave a minimum of 30 mm annular gap on the circumference.

Use heavy-duty KG pipe system components in accordance with DIN EN 1852 with push-fit socket system such as REHAU AWADUKT PP SN 10 with safety lock sealing system.

During the construction phase, close the pipe section at both ends.

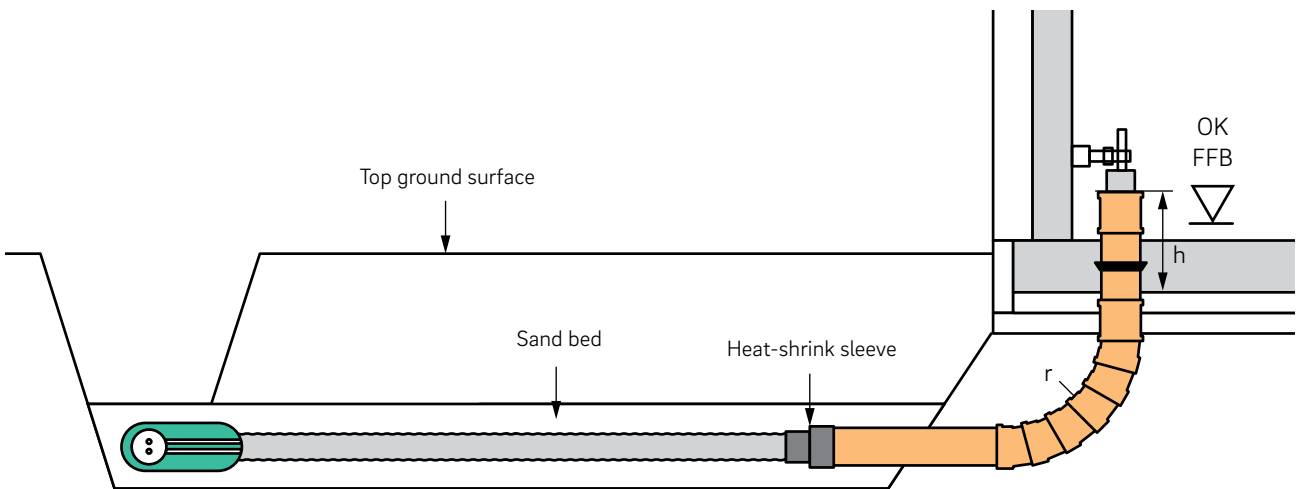

Fig. 05-21 Wall entry through a duct

05.06 End caps

End caps are used to protect the pipes where they penetrate the building wall. Depending on the pipe used, the following end caps can be used:

- RAUVITHERM
 - Rubber end caps
 - Heat-shrinkable end caps
- RAUTHERMEX
 - Rubber end caps
 - Heat-shrinkable end caps
 - Slip-on end caps

Rubber and heat-shrinkable end caps fit tightly to the pipe and provide a high protection against water and other objects entering the insulation.

End caps – rubber end caps



Fig. 05-22 Rubber end caps



Fig. 05-23 Closing pipe with rubber end cap

Factor in the installation heights of the end caps on the pipe insulation as well as on the carrier pipes.

End caps – heat-shrink and slip-on end caps



Fig. 05-24 Heat-shrink end caps

Fig. 05-25 Slip-on end caps



The end caps must be fitted prior to assembling the connecting fittings.

Shrink the heat-shrinkable end caps carefully on to the carrier pipes; do not overheat the carrier pipes when doing this. Allow to cool completely prior to further assembly of the carrier pipes.

If a pre-insulated pipe ends below ground, it is absolutely necessary to fit heat-shrink end caps or rubber end caps with on-site stainless-steel tightening straps. Slip-on end caps are not permitted in this case.

05.07 Expansion/fixing point clamps

For RAUVITHERM and RAUTHERMEX no expansion bellows or compensators must be used during below ground installation. Pipe friction in the ground is greater than the expansion forces of the plastic pipe.

In order to absorb the reaction forces of the carrier pipes in the area of wall entries that are caused by thermal expansion and shrinkage, conventional fixing point clamps must be used that can absorb the forces according to Tab. 05-8 or Tab. 05-9.

Here, the free pipe lengths should be as short as possible to limit the thermal changes in length. However, appropriate minimum lengths are required for the pipe ends to incorporate the closing of the pipe (end caps), the required fixing (fixed point), the pipe connection (fitting and installation space) and free reserve lengths for revision or alike, if required.



Fixed point clamps must be installed in a form-fit manner on the fitting grooves or on the carrier pipe, i.e. they must be fitted flush before the compression sleeve.

Fixing point clamps must not be fixed to the compression sleeves.

Alternatively, a fixed point can be made on a secondary rigid system/component or, in the case of very short house connecting pipes (< 5 m), can be replaced by designing a constructive expansion bend or compensator.

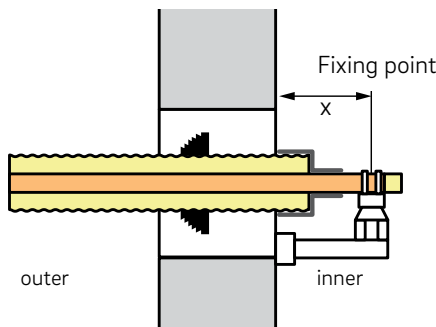

SDR 11 carrier pipe

Dimensions External diameter x wall thickness [mm]	Protrusion into the building X (min.) [mm]	Fixing point forces for each carrier pipe [kN]
20 x 1.9	400	0.6
25 x 2.3	400	0.9
32 x 2.9	400	1.3
40 x 3.7	400	2.0
50 x 4.6	450	2.9
63 x 5.8	450	4.2
75 x 6.8	450	5.3
90 x 8.2	450	6.0
110 x 10.0	450	6.3
125 x 11.4	500	7.8
140 x 12.7	500	9.8
160 x 14.6	500	12.8

Tab. 05-8 Fixing point forces of SDR 11 carrier pipes

SDR 7.4 carrier pipe

Dimensions External diameter x wall thickness [mm]	Protrusion into the building X (min.) [mm]	Fixing point forces for each carrier pipe [kN]
20 x 2.8	400	0.8
25 x 3.5	400	1.2
32 x 4.4	400	1.8
40 x 5.5	400	2.7
50 x 6.9	450	3.9
63 x 8.7	450	5.3

Tab. 05-9 Fixing point forces of SDR 7.4 carrier pipes

06 Designing and dimensioning heat networks

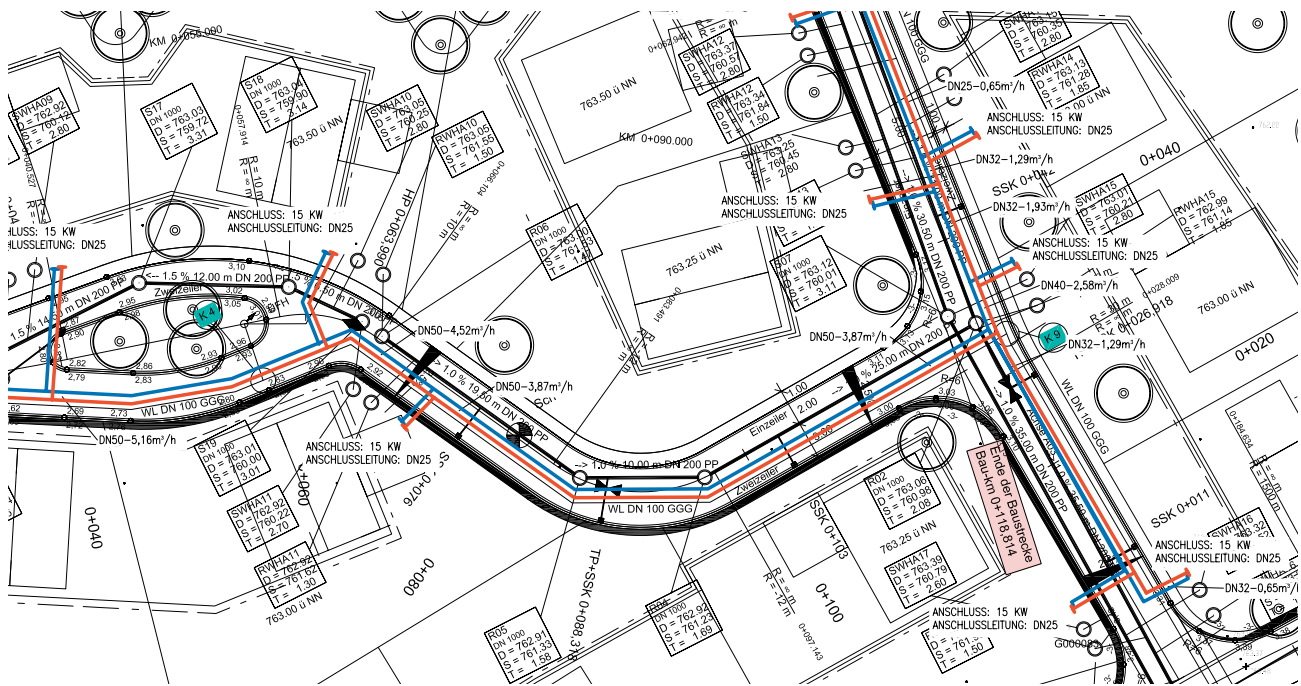

Copyright: Gebäudetechnik Planung München UG

The heat supply via a heat network generally consists of three main components:

- energy centre/heat source
- pipe network
- heat interface units (HIU)

Various energy sources and technologies can be used as a heat source. A district heat network can use the energy from a wide variety of heat-generating systems, from combined heat and power units (CHP), through renewable energy from solar thermal systems or large heat pumps to waste heat from industrial plants or biogas plants. Buffer stores are also often integrated into the energy centre in order to separate the heat generation and heat requirement in terms of time.

The heat distribution is achieved using a pipe network. The heat transfer medium, normally water, is transported in pre-insulated polymer pipes developed specially for these temperature requirements. The REHAU RAUVITHERM and RAUTHERMEX pipe systems are best suited for this.

District heating networks are almost exclusively completed as two-pipe systems (flow/return). The water heated in the energy centre is transported to the heat consumers via the flow. Via the return, the colder water gets back to the energy centre and the circle begins anew.

In a district heat network, a hydraulic separation of the primary side (district heating network) and the secondary side (end consumer heating system) is mostly carried out by the heat interface unit. As a rule, plate heat exchangers are used for this purpose. However, the separation is also possible by means of a decentralised buffer store with smooth pipe heat exchanger (see Section 06.03.02 on page 51). For small networks or connection lines, a hydraulic separation is sometimes not used.



06.01 Types of heat network

The type of heat distribution network is primarily determined by constructional conditions (design and layout of the road, arrangement of the houses to be connected, etc.), network size and integration of the heat source/s.

Essentially there are three types of networks:

Radial systems

Radial systems are most often used due to their simple structure. The short pipe runs and small diameters result in lower construction costs and heat losses. The disadvantage is that subsequent extensions are limited due to the specified limited network capacity.

Benefits:

- Simple network planning
- Network type always possible

Disadvantage:

- In comparison, the ring network often lends itself for larger supply areas with one or more heat sources.

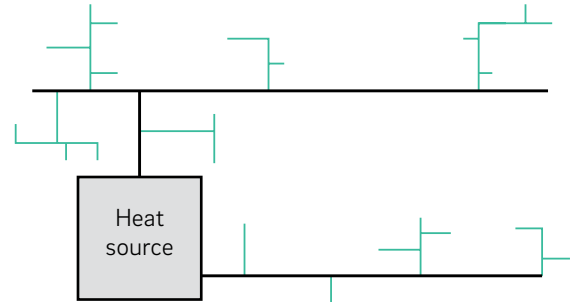

Fig. 06-1 Radial network

Ring networks

The ring network type often lends itself for large supply areas with one or more heat sources. The ring shape not only allows several heat sources to be integrated, but it also results in higher supply security, as most customers can be supplied via two supply routes. This makes subsequent extension or integration of consumers easy. The pipe runs are longer overall than for a radial system, so that the investment costs and heat losses may be higher.

Benefits:

- Integration of several heat sources
- Increased supply security

Disadvantage:

- Only possible with suitable network topology
- Higher costs, depending on the size of the ring

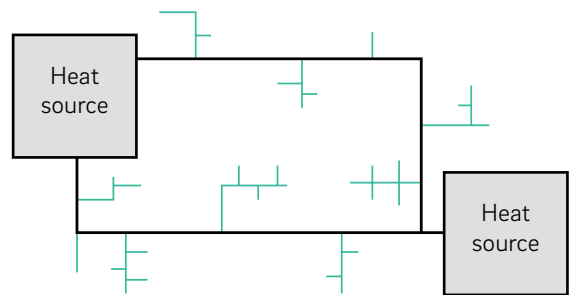

Fig. 06-2 Ring network

Meshed networks

Meshed networks are ring networks that are nested inside each other. These offer optimum supply security and better extension opportunities. Due to the high investment costs, they are mostly used for large heat distribution networks in inner-city areas.

Benefits:

- Optimum supply security
- Extension possible

Disadvantage:

- High costs, mostly for large networks

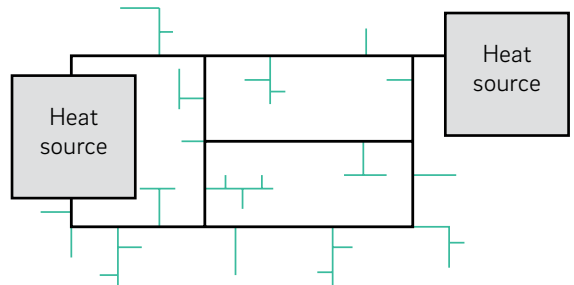

Fig. 06-3 Meshed network

06.02 Connection options

The following options are available for connecting the heat consumer to the heat network:

Branch method

This method is the standard way for connecting the consumer to a heating network. Every customer is connected to heat network individually or in groups.

Benefits:

- Flexibility in design
- Easy installation prior to buildings being erected
- Branches can be connected to the main line at a later stage

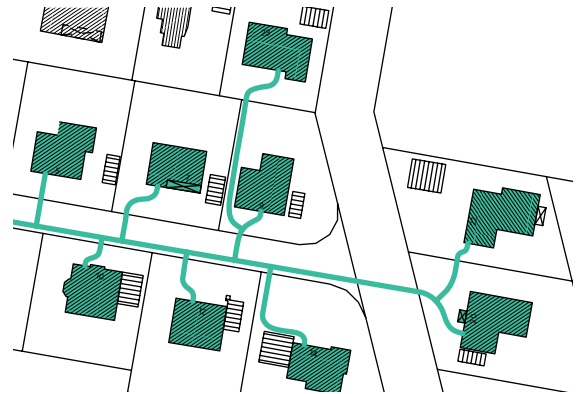

Fig. 06-4 Branch method

House-to-house line arrangement/building-to-building piping

In a house-to-house line arrangement, houses are connected to each other and only connected to a main line as a group.

Building-to-building piping is only used in an individual case.

Benefits:

- No connections below grade
- Little installation in sealed land

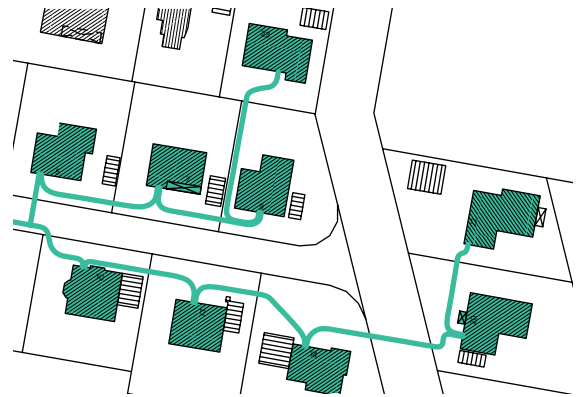

Fig. 06-5 House-to-house line arrangement/
building-to-building piping

Connecting different pipe systems

Various pipe systems are available for heat distribution. These can be combined with each other, e.g. in a network extension to an existing steel network, the connection lines of the house to be connected can be created with a flexible plastic carrier pipe such as RAUTHERMEX. A combination of various polymer systems such as RAUTHERMEX and RAUVITHERM can also make sense due to their different properties.

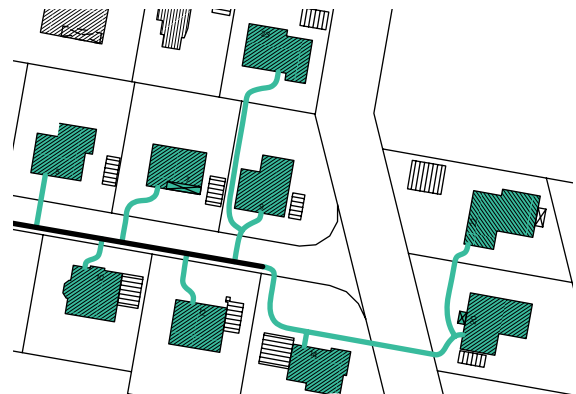

Fig. 06-6 Connecting different pipe systems

06.03 Network sizing

A district heat network is generally operated all year round. It is designed for the peak load in winter. For the majority of the year, the heating network is only operated at partial load, and the maximum output is only required for a few hours a year. This is evident from the so-called actual annual consumption load profile (see Fig. 06-7) of a district heating network.

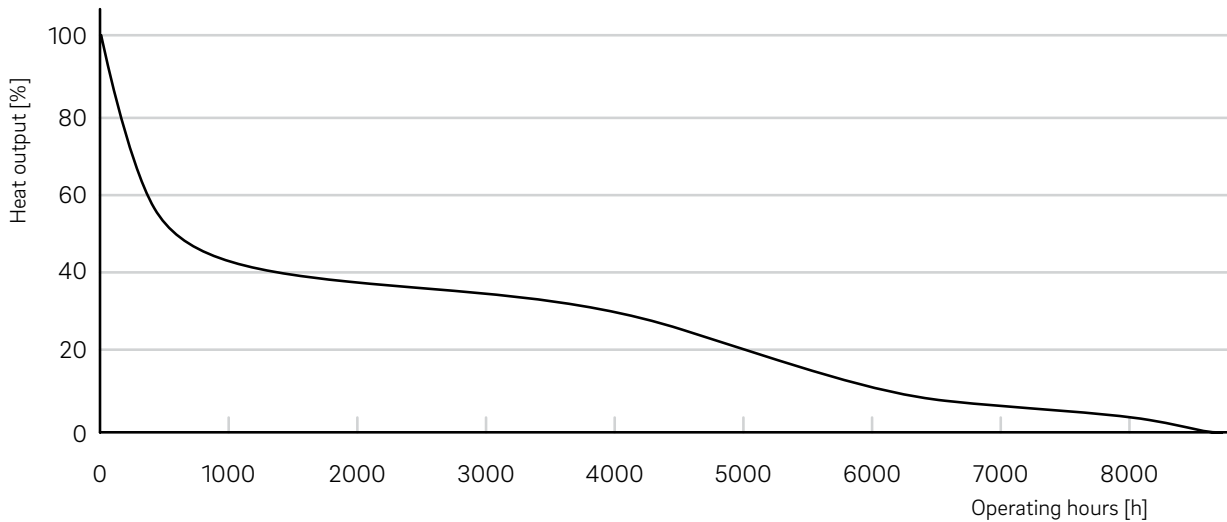

Fig. 06-7 Ordered annual load duration curve

Generally the district heating network should be designed as efficiently as possible. Efficient planning and design is the basis for a technically practical as well as economically feasible district heat network.



The following steps are to be considered:

1. Understanding the heat requirement
 2. Clarification of the heat supply and buffer store concept
 3. Establishing the pipe routing
 4. Determining the load diversity
 5. Layout of the heat source and buffer store
 6. Establishing the required velocities/temperature difference
 7. Pre-sizing the district heating line/determining the critical path
 8. Final sizing
 9. Pump sizing
-

06.03.01 Understanding the heat requirement

For an early estimate of the cost-efficiency a rough pipe layout is to be created on the basis of initial data collection. The pipe length, the number of connection points and their heat requirement have a big influence on the efficiency of a district heat network and funding-relevant key figures, e.g. heat load or the percentage heat loss.

The cost efficiency of a district heat network usually increases with the number of consumers connected to it. By improving the area connection density, the pipe length between connections can also be reduced. However, not connecting individual connection points that are located further away may have a positive effect on the overall efficiency under certain circumstances.

Once the network structure has been fixed, the nominal output or the maximum heat requirement of each individual connection point is to be established. Using reliable data is an important prerequisite for an efficient and cost-effective network design.

In practice, a heat load calculation is rarely carried out for an initial estimate calculation. For the calculation, two variants have proven to be useful for calculating the heat load/the heat requirement:

- Energy consumption from previous years taking into account the efficiency rate and the full utilisation hours of the boiler
- Energy consumption characteristic value (energy consumption with regard to the living area to be heated) and the full utilisation hours

When supplying residential buildings, domestic hot water must be given particular attention. The maximum heat requirement for domestic hot water exceeds the requirement for room heating, sometimes substantially, depending on the system.

06.03.02 Clarification of the heat supply and buffer store concept



Fig. 06-8 Central heat store

Already at an early stage of planning a district heating network, it must be clarified which heat supply or which buffer store concept is meant to be implemented. In most cases the heat is generated centrally and distributed by the energy centre. However, the integration of several heat sources at different supply points is also possible. Another aspect that is to be clarified early on is the buffer management. As the heat requirement in a district heat network is subject to load changes that vary not only seasonally but also daily, the use of buffer stores is sensible. This means that the heat generation and the heat requirement can be separated in terms of time.



The use of central buffer stores has an influence just on the heat generation. If, in contrast, decentralised buffer stores are installed for each individual connection point, this also has a positive effect on the pipe dimensioning, as the heat is transported consistently over the course of time.



Fig. 06-9 Decentralised heat store

The heat supply and buffer storage concept has a significant influence on the size of the coincidence factors in the individual route sections of the entire thermal network.

06.03.03 Establishing the pipe route and location of the energy centre

In parallel to the activities described so far, a provisional pipeline route and the location of one or, if necessary, more heat generators must be specified. This is necessary in order to be able to determine the simultaneous consumption for the individual pipe routes at a later stage (see Chapter 06.03.04). For the pipe route local conditions, e.g. courses of rivers, roads to be crossed, etc. are to be taken into account in particular and considered in the layout. A location of the energy centre in the centre of the supply area or in the vicinity of larger heat consumers is advantageous with regard to the network dimensioning.

06.03.04 Determining load diversity

Due to the consumers' individual heat requirements at different times, the load peaks are distributed over the course of time. This effect is taken into account by the load diversity, which is defined as the ratio of the actual required maximum total load to the sum of the nominal loads of all the connection points.

$$GLF = \frac{\dot{Q}_{\max, \text{required}}}{\sum \dot{Q}_{\text{Nominal}}}$$

GLF diversity

$\dot{Q}_{\max, \text{required}}$ actual maximum required total load
 $\sum \dot{Q}_{\text{Nominal}}$ total nominal load of all connection points

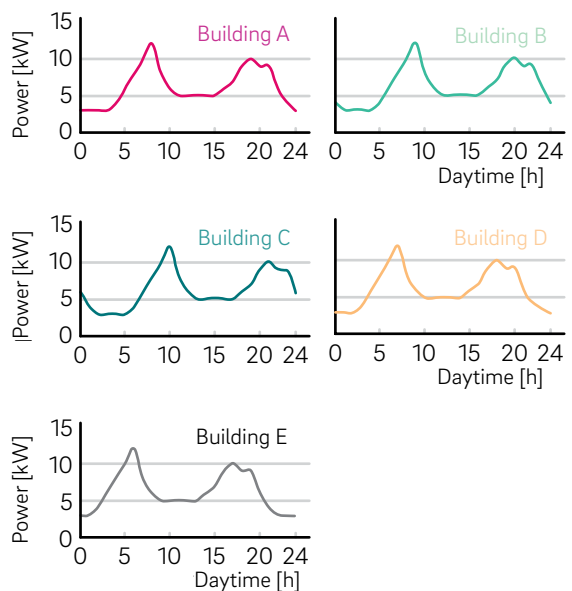

Fig. 06-10 Schematic illustration: Performance profile of the various consumers in the heating network

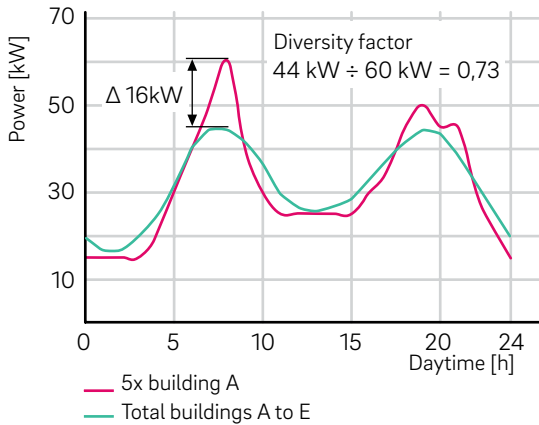

Fig. 06-11 Schematic illustration: Performance profile with diversity, illustrated for 5 buildings

Example:

- Number of connection points: 80
- Nominal load per connection point: 15 kW
- Actual maximum required total load: 756 kW

$$GLF = \frac{\dot{Q}_{\max, \text{required}}}{\sum \dot{Q}_{\text{Nominal}}} = \frac{756 \text{ kW}}{80 \cdot 15 \text{ kW}} = 0.63$$

A coincidence factor of 0.63 is obtained. For the total nominal output of all connection points as a result 1200 kW doesn't have to be supplied, but just 756 kW transported through the main line.

The effect of the simultaneous demand has an effect both on the generation of heat as well as on the heat network itself. As a result, the pipes of the heat network can be designed smaller.

Historical values and investigations show that with an increasing number of consumers a lower simultaneous consumption is achieved. Depending on the number of consumers, the resulting diversity factor is a theoretical factor between 0.5 and 1.0 (see Fig. 06-12).

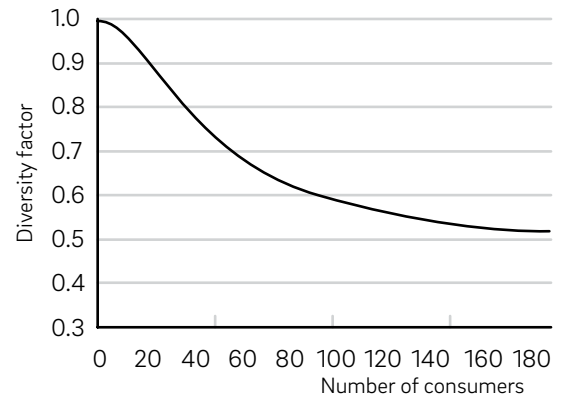

Fig. 06-12 Schematic illustration: Simultaneous demand of the total heat requirement depending on the number of consumers for a homogeneous consumer structure in the existing building

The diversity is not only dependent on the number of connection points but also on their nominal output, the building type (e.g. new construction or existing building), the nature of the domestic hot water concept and, last but not the least, the use of possible buffer stores. When using decentralised buffer stores, a separate analysis is required. The peak loads that occur are absorbed by the buffer store on the secondary side in some cases and therefore evened out.

Projects with domestic hot water being generated at the consumer instantaneously requiring a high input, require special consideration. In this case, the heat demands for the building heating and for the domestic hot water generation are recorded separately (see object questionnaire, page 68). For the domestic hot water generation, separate diversity is determined depending on the number of connection points. The diversity differs significantly from those relating to the total heat requirement. Such systems are mainly used in apartment buildings.

In summary, the following influencing factors must be taken into account when calculating diversity:

- Number of connection points
- Nominal output of the individual connection points
- Connection point building type (new construction/existing building)
- Buffer store concept
- Concept for domestic hot water

As diversity is dependent on several factors, there is not a standard factor for a district heating network. It must be calculated for each individual pipe or individual section. Generally the diversity is lowest at the main pipe by the energy centre and increases towards the end of the network at the house connection pipes.



The REHAU design centre can calculate the simultaneous consumptions for individual projects and incorporate the results into the layout.



It is essential to take the diversity factor into account for an efficient layout. If the diversity is not taken into account, the network is over-dimensioned, which leads to unnecessarily high capital and operating costs!

06.03.05 Sizing of the heat source and buffer store

The maximum required output for the heat network is crucial for the sizing of the heat source/s and buffer store. Usually the heat supply is achieved with several heat sources.

One refers to a modular heat supply, if dependent on the heat demand, different heat generators are used with each one working in its optimal load range.

- Base load (e.g. via the block-type thermal power station)
- Average load (e.g. with a wood chip boiler)
- Peak load (e.g. with an oil boiler)

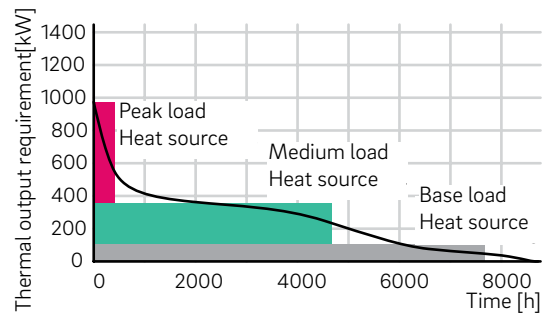

Fig. 06-13 Annual load duration curve with modular heat generator

The selection of the heat source must be matched to the resources available locally.

In order to further minimise any cycling of the heat source, it is useful to use buffer stores. As mentioned in Chapter 06.03.02, these can be integrated centrally or decentralised into the network. The dimensioning of the buffer store must be coordinated with the heat source, the varying heat requirement over time and the constructional conditions.

06.03.06 Establishing the required velocities/temperature drops

If the pipe route and heat loads are known, the velocities required for the actual dimensioning of the heating pipe section can be calculated. To do this, the desired temperature drop in the network, i.e. the difference between the flow temperature and the return temperature, must be defined.

$$\dot{V} = \frac{\dot{Q}}{c_p \cdot (\vartheta_V - \vartheta_R) \cdot \rho}$$

\dot{V} Velocity [l/s]

\dot{Q} Heat flow [kW]

c_p Specific heat capacity water [kJ/kg·K]

ϑ_V Flow temperature in the network [°C]

ϑ_R Return temperature in the network [°C]

ρ Density [kg/l]

Typical flow temperatures in district heating networks are 60–80 °C, return temperatures 30–60 °C.

In practice the temperature drops are usually between 20 K and 40 K. Temperature drops are maximised as much as possible as this reduces the required velocity for a given heat load. In general however, the system temperatures should be kept as low as possible in order to avoid unnecessary heat losses.

Velocity and temperature drops are though not constant at the same value throughout the year. The maximum required load is usually only needed on the coldest days in the winter months, which is why it also doesn't have to be maintained throughout the year. Accordingly, in most cases the network is run by a combination of velocity control and temperature control. With this type of combined control process, it is possible to quickly react to short-term load peaks by increasing the velocity and by supplying heat, e.g. from a buffer. Temporary and seasonal load changes can be compensated for by controlling the temperature of the network, so that when the load required is lower the heat losses are also lower (see Fig. 06-14).

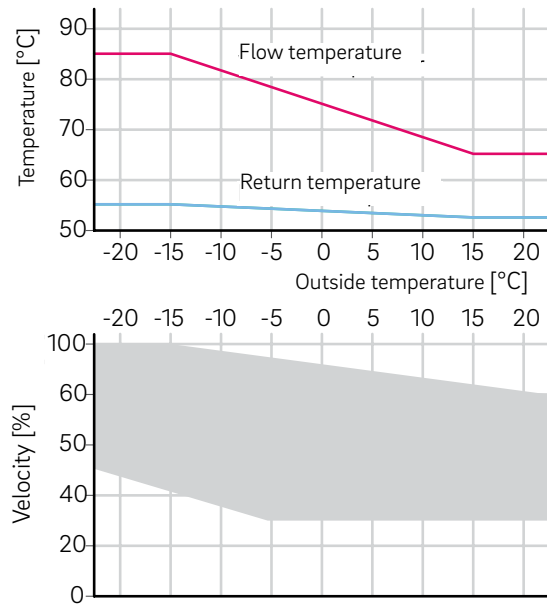

Fig. 06-14 Network control, floating operation of temperature and flow control

06.03.07 Pre-dimensioning the heat network pipes / identifying the critical path

The basis for dimensioning is the maximum required velocities of the individual runs. For the sizing, the following principle applies: as small as possible, as big as necessary. Using the following graph, the effect on the costs of the selected pipe dimension is illustrated:

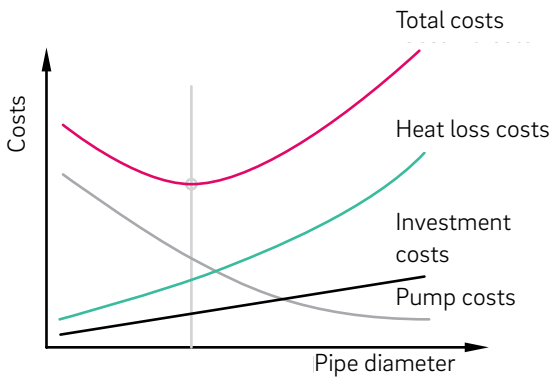

Fig. 06-15 Heating network costs depending on the pipe diameter

On one hand, the investment costs as well as heat loss costs rise with increasing pipe diameter. On the other hand, the pump flow costs are reduced due to the lower pressure losses in the network. Optimum dimensioning minimises the overall costs.

If dimensioning the entire pipe network, the maximum permissible pressure load must be observed.

The total load on the pipe system consists of main components:

- Excess operating pressure
- Geodetic pressure (static)
- Flow pressure loss in pipes, fittings, valves and HIUs

The excess operating pressure (usually approx. 1.5 bar), the geodetic pressure as well as the pressure loss through the heat transfer or the heat interface unit respectively determine the maximum permissible flow pressure loss in the network.

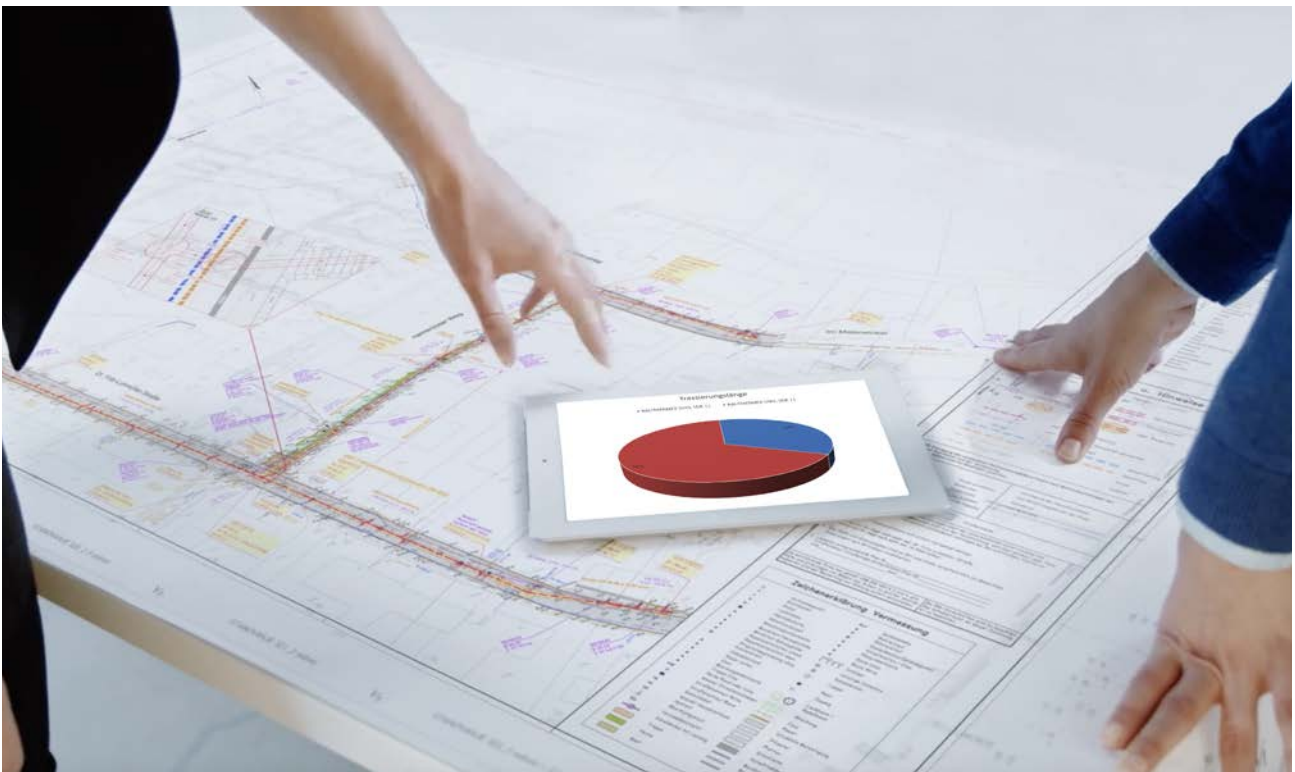

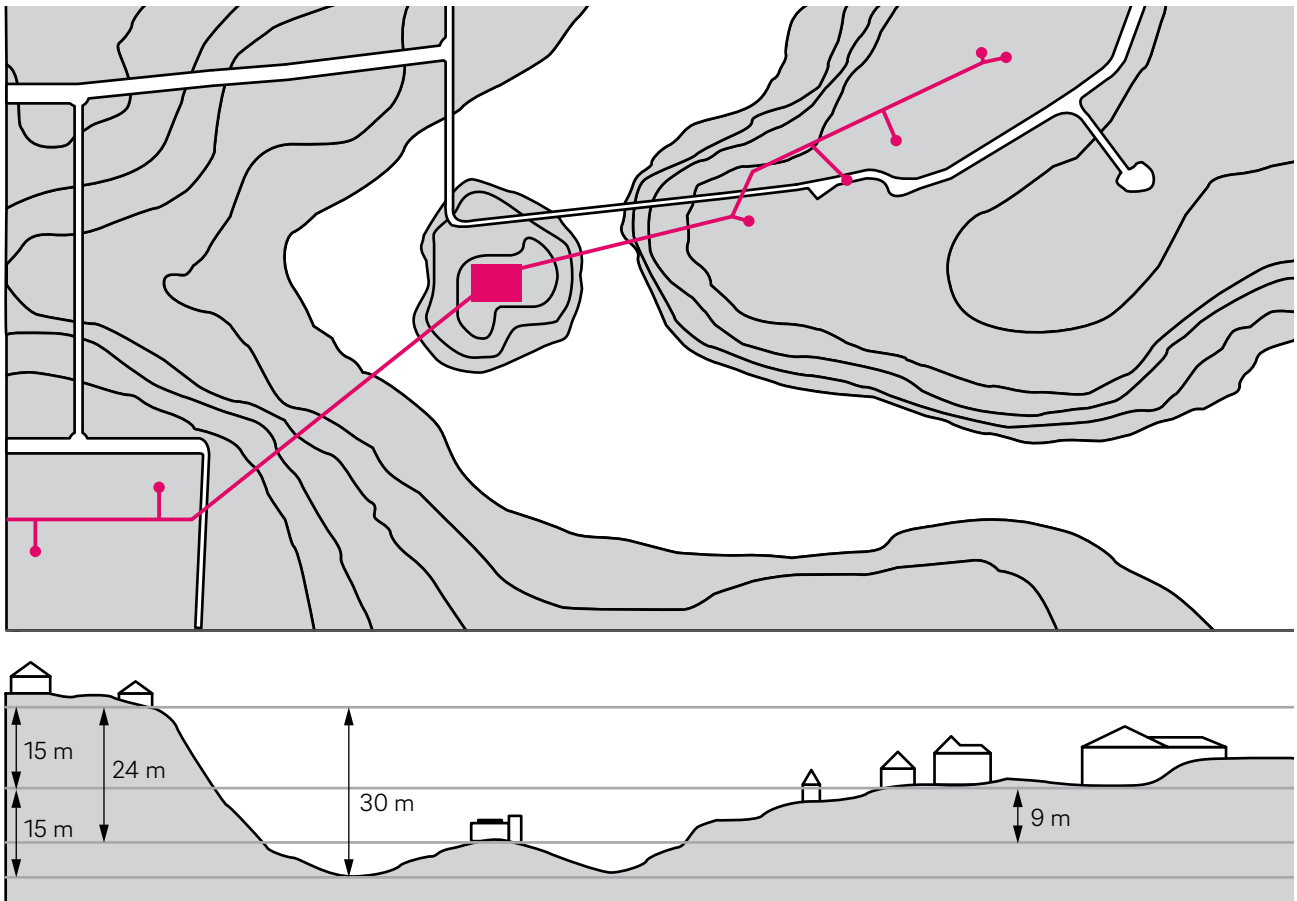

Fig. 06-16 Example of elevation profile of a heat network

The specific pressure loss is used as the basis for the initial pre-dimensioning. Depending on the network size, 200–250 Pa/m is used as a guide value in practice. The aim of pre-dimensioning is to identify the critical path and its pressure loss in the entire network.

Dimensioning and pressure loss calculation, SDR 11 pipes

The tables and the temperature-dependent correction factors on the following pages can be used for dimensioning the pipes and calculating the pressure losses. These tables apply for both UNO and DUO pipes.

The procedure is outlined in the following example.

Example and step-by-step process:

Starting point: 46 kW should be transported across a 100 m long course. There is a difference of 20 K in the network.

1. Calculating the load to be transported in the section and the velocity:
46 kW with a difference of 20 K gives you a velocity of 0.55 l/s
2. Pre-dimensioning:
The pipe should be sized to be as small as possible, but not exceed the specific pressure loss of 200–250 Pa/m: Select the dimension 40 x 3.7 (specific pressure loss is 135.4 Pa/m)
3. Determining the pressure loss:
A pipe route length of 100 m gives you a total pipe length of 200 m

$$R_{\text{total}} = 200 \text{ m} \cdot 135.4 \text{ Pa/m} = 27080 \text{ Pa} = 0.27 \text{ bar}$$

The pressure losses are also dependent on the temperature of the medium. The pressure losses specified in the tables apply to water and for a water temperature of 80 °C. The lower the temperature of the water, the higher the viscosity and the higher the pressure loss. In the case of varying temperatures, the pressure losses can be calculated in an approximate manner with the reference values (factors) for the respective water temperatures specified in the table "Pressure loss with water temperatures varying from 10 °C to 95 °C" on page 61. If all sections are pre-dimensioned in this way, one can identify the critical path by adding up the pressure losses of the individual sections. In most cases this will be the path to the most distant connection point. In most cases this is the connection point that is furthest away.

In addition, the individual resistances (zeta values) of the fittings in the respective route section or nodal points must be taken into account for the pressure loss calculation. For this, the following guide values can be used for each component.

Designation	Symbol	ζvalue
90° angle		1.3
T-piece distribution passage		0.3
T-piece splitting branch flow		1.3
T-piece splitting flow ends		1.5
T-piece merging passage		0.9
T-piece merging outlet		2.0
T-piece merging counter-clockwise		3.0
Reduction		0.4

Tab. 06-1 ζ Guide values for fittings

The ζ values must only be used as guide values. In fact, they are dependent on the exact fitting geometries and the velocities in the fittings. This also results in a differentiation between compression sleeve fittings and FUSAPEX fittings.

The values are acceptable for an approximate calculation, as they are not very significant in the usual pipeline run with comparatively long pipe sections.



In the context of our REHAU planning support, the ζ values of the project specific individual components in the pipe run are taken into account.

06.03.08 Final dimensioning

In many cases, the pipes that are not on the critical path can be sized to even smaller pipes sizes. Here there can be a variation from the guide value of the specific pressure loss. A somewhat higher pressure loss in the sub-legs compensates for the hydraulic equalisation that is required anyway. In addition to this, a more streamlined dimensioning of the non-critical subsections reduces investment and heat loss.

Two aspects are to be considered for this final dimensioning:

- The velocity in the pipes must not exceed 0.7–2.0 m/s depending on pipe size (see Tab. 06-2 ff. grey area)
- By adjusting the pipe sizes on the non-critical subsections, their pressure loss must not exceed the pressure loss of the original determined critical path.

Following dimensioning, special network situations must be considered separately again, for example

- Specifying pre-insulated shut-off valves
 - Transition from UNO to DUO pipes
 - Use of Y-pipes at house connections
 - Consolidation and connection of neighbouring connection points to the main line/to a subleg
- Changes as a result of this must then be fed back into the network sizing.



All steps described from Section 06.03.01 to Section 06.03.08 are to be considered for the efficient layout of a district heating network.

06.03.09 Pump sizing

The pump head and the maximum velocity to be transported are important for the pump sizing and are derived from the actual network planning.

For efficiency reasons, the use of variable speed pumps is recommended in heat networks.

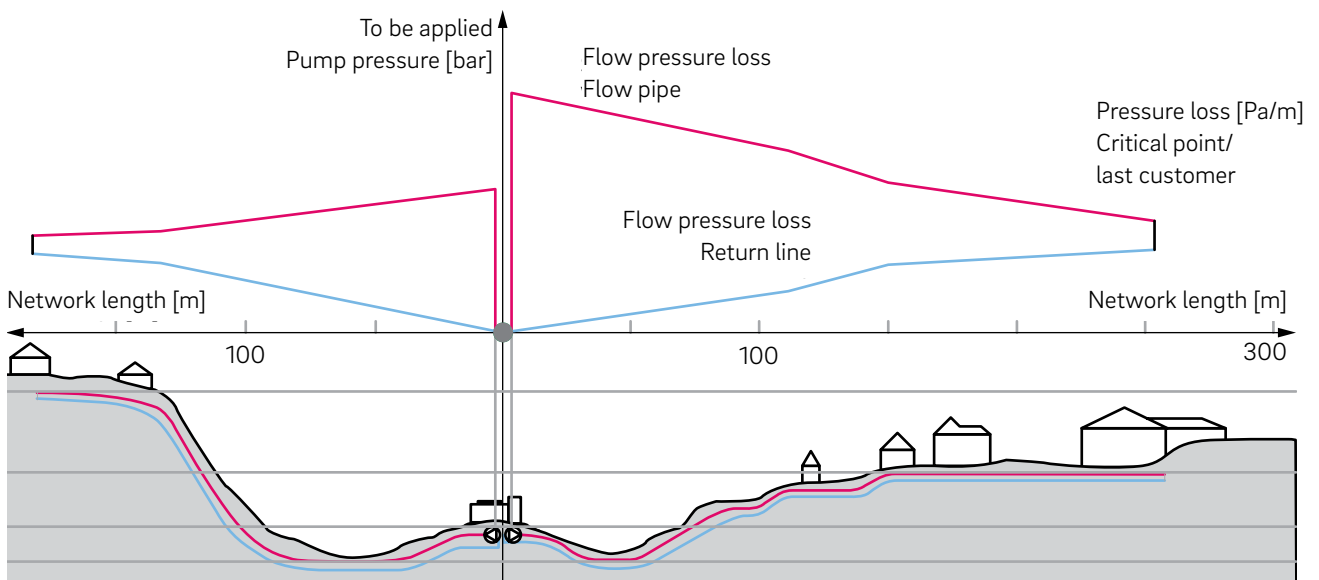

Fig. 06-17 Pump sizing

Pressure loss of SDR 11 carrier pipes at 80 °C

Velocity		Output at a temperature difference of			20 x 1.9		25 x 2.3		32 x 2.9		40 x 3.7		50 x 4.6		63 x 5.8	
[l/s]	[l/h]	20 K	30 K	40 K	v	R	v	R	v	R	v	R	v	R	v	R
		[kW]	[kW]	[kW]	[m/s]	[Pa/m]	[m/s]	[Pa/m]	[m/s]	[Pa/m]	[m/s]	[Pa/m]	[m/s]	[Pa/m]	[m/s]	[Pa/m]
0.06	216	5.0	7.5	10.0	0.29	75.1	0.18	25.0	-	-	-	-	-	-	-	-
0.07	252	5.9	8.8	11.7	0.34	98.6	0.21	32.7	-	-	-	-	-	-	-	-
0.08	288	6.7	10.0	13.4	0.39	124.9	0.24	41.4	-	-	-	-	-	-	-	-
0.09	324	7.5	11.3	15.1	0.44	154.0	0.28	50.9	-	-	-	-	-	-	-	-
0.10	360	8.4	12.6	16.7	0.49	185.8	0.31	61.4	-	-	-	-	-	-	-	-
0.11	396	9.2	13.8	18.4	0.53	220.3	0.34	72.6	-	-	-	-	-	-	-	-
0.12	432	10.0	15.1	20.1	0.58	257.4	0.37	84.8	-	-	-	-	-	-	-	-
0.13	468	10.9	16.3	21.8	0.63	297.2	0.40	97.7	0.24	29.4	-	-	-	-	-	-
0.14	504	11.7	17.6	23.4	0.68	339.5	0.43	111.5	0.26	33.6	-	-	-	-	-	-
0.15	540	12.6	18.8	25.1	0.73	384.4	0.46	126.2	0.28	37.9	-	-	-	-	-	-
0.16	576	13.4	20.1	26.8	0.78	431.9	0.49	141.6	0.30	42.5	-	-	-	-	-	-
0.18	648	15.1	22.6	30.1	0.87	534.5	0.55	174.9	0.33	52.4	-	-	-	-	-	-
0.20	720	16.7	25.1	33.5	0.97	647.1	0.61	211.3	0.37	63.2	-	-	-	-	-	-
0.22	792	18.4	27.6	36.8	1.07	769.6	0.67	250.9	0.41	74.9	-	-	-	-	-	-
0.24	864	20.1	30.1	40.2	1.16	902.0	0.73	293.5	0.45	87.5	-	-	-	-	-	-
0.26	936	21.8	32.7	43.5	1.26	1044.1	0.80	339.3	0.48	101.0	0.31	35.3	-	-	-	-
0.28	1008	23.4	35.2	46.9	1.36	1196.0	0.86	388.1	0.52	115.4	0.34	40.3	-	-	-	-
0.30	1080	25.1	37.7	50.2	1.46	1357.6	0.92	439.9	0.56	130.7	0.36	45.5	-	-	-	-
0.35	1260	29.3	44.0	58.6	-	-	1.07	582.4	0.65	172.5	0.42	60.0	-	-	-	-
0.40	1440	33.5	50.2	67.0	-	-	1.22	743.5	0.74	219.6	0.48	76.3	-	-	-	-
0.45	1620	37.7	56.5	75.3	-	-	1.38	922.9	0.83	272.0	0.54	94.3	0.34	31.9	-	-
0.50	1800	41.9	62.8	83.7	-	-	-	-	0.93	329.4	0.60	114.0	0.38	38.6	-	-
0.60	2160	50.2	75.3	100.5	-	-	-	-	1.11	459.6	0.72	158.6	0.46	53.5	-	-
0.70	2520	58.6	87.9	117.2	-	-	-	-	1.30	609.8	0.84	209.8	0.54	70.7	-	-
0.80	2880	67.0	100.5	134.0	-	-	-	-	1.48	779.8	0.96	267.7	0.61	90.0	-	-
0.90	3240	75.3	113.0	150.7	-	-	-	-	-	-	1.08	332.0	0.69	111.4	0.43	36.4
1.00	3600	83.7	125.6	167.4	-	-	-	-	-	-	1.20	402.8	0.76	134.9	0.48	44.1
1.10	3960	92.1	138.1	184.2	-	-	-	-	-	-	1.32	480.0	0.84	160.5	0.53	52.3
1.20	4320	100.5	150.7	200.9	-	-	-	-	-	-	1.44	563.5	0.92	188.1	0.58	61.3
1.30	4680	108.8	163.3	217.7	-	-	-	-	-	-	-	-	0.99	217.8	0.63	70.8
1.40	5040	117.2	175.8	234.4	-	-	-	-	-	-	-	-	1.07	249.5	0.67	81.0
1.50	5400	125.6	188.4	251.2	-	-	-	-	-	-	-	-	1.15	283.2	0.72	91.9
1.60	5760	134.0	200.9	267.9	-	-	-	-	-	-	-	-	1.22	318.8	0.77	103.4
1.80	6480	150.7	226.0	301.4	-	-	-	-	-	-	-	-	1.38	396.2	0.87	128.2
2.00	7200	167.4	251.2	334.9	-	-	-	-	-	-	-	-	1.53	481.3	0.96	155.4
2.20	7920	184.2	276.3	368.4	-	-	-	-	-	-	-	-	1.68	574.3	1.06	185.1
2.40	8640	201	301	402	-	-	-	-	-	-	-	-	1.84	675.1	1.16	217.2
2.60	9360	218	327	435	-	-	-	-	-	-	-	-	1.99	783.6	1.25	251.8
2.80	10080	234	352	469	-	-	-	-	-	-	-	-	-	-	1.35	288.7
3.00	10800	251	377	502	-	-	-	-	-	-	-	-	-	-	1.45	327.9
3.25	11700	272	408	544	-	-	-	-	-	-	-	-	-	-	1.57	380.4
3.50	12600	293	440	586	-	-	-	-	-	-	-	-	-	-	1.69	436.5
3.75	13500	314	471	628	-	-	-	-	-	-	-	-	-	-	1.81	496.2
4.00	14400	335	502	670	-	-	-	-	-	-	-	-	-	-	1.93	559.6

Tab. 06-2 Part 1 of the pressure loss table for SDR 11 carrier pipes at 80 °C

Recommended design range for REHAU SDR 11 carrier pipes with REHAU jointing technique:

	Compression sleeve jointing technique and/or FUSAPEX recommended
--	--

	FUSAPEX jointing technique recommended
--	--

	maximum possible velocity for compression sleeve jointing technique
--	---

	(max. velocity with partly very high pressure drop (Pa/m) → no longer recommended in the critical leg)
--	--

Pressure loss of SDR 11 carrier pipes at 80 °C

Velocity		Output at a temperature difference of			75 x 6.8		90 x 8.2		110 x 10		125 x 11.4		140 x 12.7		160 x 14.6	
					v	R	v	R	v	R	v	R	v	R	v	R
[l/s]	[l/h]	20 K	30 K	40 K	[m/s]	[Pa/m]	[m/s]	[Pa/m]	[m/s]	[Pa/m]	[m/s]	[Pa/m]	[m/s]	[Pa/m]	[m/s]	[Pa/m]
2.40	8640	201	301	402	0.81	91.3	0.56	37.9	-	-	-	-	-	-	-	-
2.60	9360	218	327	435	0.88	105.7	0.61	43.8	-	-	-	-	-	-	-	-
2.80	10080	234	352	469	0.95	121.0	0.66	50.1	-	-	-	-	-	-	-	-
3.00	10800	251	377	502	1.01	137.4	0.71	56.8	-	-	-	-	-	-	-	-
3.25	11700	272	408	544	1.10	159.2	0.76	65.8	-	-	-	-	-	-	-	-
3.50	12600	293	440	586	1.18	182.4	0.82	75.3	-	-	-	-	-	-	-	-
3.75	13500	314	471	628	1.27	207.2	0.88	85.5	-	-	-	-	-	-	-	-
4.00	14400	335	502	670	1.35	233.4	0.94	96.2	-	-	-	-	-	-	-	-
4.25	15300	356	534	712	1.44	261.2	1.00	107.6	0.67	40.4	-	-	-	-	-	-
4.50	16200	377	565	753	1.52	290.4	1.06	119.5	0.71	44.8	-	-	-	-	-	-
4.75	17100	398	597	795	1.60	321.0	1.12	132.0	0.75	49.5	-	-	-	-	-	-
5.00	18000	419	628	837	1.69	353.1	1.18	145.1	0.79	54.4	-	-	-	-	-	-
5.25	18900	440	659	879	1.77	386.7	1.23	158.8	0.83	59.5	-	-	-	-	-	-
5.50	19800	460	691	921	1.86	421.7	1.29	173.0	0.86	64.8	-	-	-	-	-	-
5.75	20700	481	722	963	1.94	458.1	1.35	187.9	0.90	70.3	-	-	-	-	-	-
6.00	21600	502	753	1005	-	-	1.41	203.3	0.94	76.0	-	-	-	-	-	-
6.25	22500	523	785	1047	-	-	1.47	219.3	0.98	81.9	-	-	-	-	-	-
6.50	23400	544	816	1088	-	-	1.53	235.8	1.02	88.0	-	-	-	-	-	-
7.0	25200	586	879	1172	-	-	1.65	270.7	1.10	100.9	0.85	54.3	-	-	-	-
7.5	27000	628	942	1256	-	-	1.76	307.8	1.18	114.6	0.91	61.6	-	-	-	-
8.0	28800	670	1005	1340	-	-	1.88	347.1	1.26	129.2	0.98	69.4	-	-	-	-
8.5	30600	712	1067	1423	-	-	2.00	388.7	1.34	144.5	1.04	77.6	-	-	-	-
9.0	32400	753	1130	1507	-	-	-	-	1.41	160.7	1.10	86.2	-	-	-	-
9.5	34200	795	1193	1591	-	-	-	-	1.49	177.6	1.16	95.3	-	-	-	-
10.0	36000	837	1256	1674	-	-	-	-	1.57	195.4	1.22	104.7	0.97	59.8	-	-
10.5	37800	879	1319	1758	-	-	-	-	1.65	214.0	1.28	114.6	1.02	65.5	-	-
11.0	39600	921	1381	1842	-	-	-	-	1.73	233.4	1.34	125.0	1.07	71.3	-	-
12.0	43200	1005	1507	2009	-	-	-	-	1.89	274.5	1.46	146.9	1.16	83.8	-	-
13.0	46800	1088	1633	2177	-	-	-	-	2.04	318.8	1.58	170.4	1.26	97.2	0.97	50.9
14.0	50400	1172	1758	2344	-	-	-	-	-	-	1.71	195.7	1.36	111.5	1.04	58.4
15.0	54000	1256	1884	2512	-	-	-	-	-	-	1.83	222.6	1.45	126.7	1.12	66.3
16.0	57600	1340	2009	2679	-	-	-	-	-	-	1.95	251.1	1.55	142.9	1.19	74.7
17.0	61200	1423	2135	2846	-	-	-	-	-	-	-	-	1.65	160.0	1.27	83.6
18.0	64800	1507	2260	3014	-	-	-	-	-	-	-	-	1.75	178.0	1.34	92.9
19.0	68400	1591	2386	3181	-	-	-	-	-	-	-	-	1.84	196.9	1.41	102.8
20.0	72000	1674	2512	3349	-	-	-	-	-	-	-	-	1.94	216.7	1.49	113.0
21.0	75600	1758	2637	3516	-	-	-	-	-	-	-	-	-	-	1.56	123.8
22.0	79200	1842	2763	3684	-	-	-	-	-	-	-	-	-	-	1.64	135.0
24.0	86400	2009	3014	4019	-	-	-	-	-	-	-	-	-	-	1.79	158.8
26.0	93600	2177	3265	4353	-	-	-	-	-	-	-	-	-	-	1.93	184.5
28.0	100800	2344	3516	4688	-	-	-	-	-	-	-	-	-	-	2.08	212.0
30.0	108000	2512	3767	5023	-	-	-	-	-	-	-	-	-	-	-	-

Tab. 06-3 Part 2 of the pressure loss table for SDR 11 carrier pipes at 80 °C
 Recommended layout area for REHAU SDR 11 carrier pipes with REHAU jointing technique:
 Compression sleeve jointing technique and/or FUSAPEX recommended
 FUSAPEX jointing technique recommended
x_{xx} maximum possible velocity for compression sleeve jointing technique
 (max. velocity with partly very high pressure drop (Pa/m) → no longer recommended in the critical path)

Pressure loss with water temperatures varying from 10 °C to 95 °C

Temperature of medium	10°C	15°C	20°C	25	30°C	35°C	40°C	45	50 °C	55°C	60°C	65°C	70°C	75°C	80°C	85°C	90°C	95°C
Correction factor for pressure loss	1.333	1.292	1.255	1.227	1.197	1.170	1.145	1.122	1.101	1.082	1.063	1.046	1.030	1.014	1.000	0.986	0.973	0.961

Pressure loss of SDR 7.4 carrier pipes at 80 °C

Velocity		20 x 2.8		25 x 3.5		32 x 4.4		40 x 5.5		50 x 6.9		63 x 8.6	
[v/s]	[l/h]	v	R	v	R	v	R	v	R	v	R	v	R
		[m/s]	[Pa/m]	[m/s]	[Pa/m]	[m/s]	[Pa/m]	[m/s]	[Pa/m]	[m/s]	[Pa/m]	[m/s]	[Pa/m]
0.040	144	0.25	64.7	0.16	22.3	-	-	-	-	-	-	-	-
0.045	162	0.28	79.6	0.18	27.4	-	-	-	-	-	-	-	-
0.050	180	0.31	95.8	0.20	33.0	-	-	-	-	-	-	-	-
0.055	198	0.34	113.3	0.22	39.0	-	-	-	-	-	-	-	-
0.060	216	0.37	132.1	0.24	45.4	-	-	-	-	-	-	-	-
0.065	234	0.40	152.2	0.26	52.2	-	-	-	-	-	-	-	-
0.070	252	0.43	173.6	0.28	59.5	-	-	-	-	-	-	-	-
0.075	270	0.46	196.3	0.29	67.2	-	-	-	-	-	-	-	-
0.080	288	0.49	220.2	0.31	75.3	-	-	-	-	-	-	-	-
0.085	306	0.52	245.3	0.33	83.9	-	-	-	-	-	-	-	-
0.090	324	0.55	271.7	0.35	92.8	0.21	27.5	-	-	-	-	-	-
0.095	342	0.58	299.3	0.37	102.2	0.22	30.3	-	-	-	-	-	-
0.10	360	0.61	328.1	0.39	111.9	0.24	33.1	-	-	-	-	-	-
0.11	396	0.68	389.3	0.43	132.6	0.26	39.2	-	-	-	-	-	-
0.12	432	0.74	455.2	0.47	154.8	0.28	45.7	-	-	-	-	-	-
0.13	468	0.80	525.9	0.51	178.6	0.31	52.7	-	-	-	-	-	-
0.14	504	0.86	601.3	0.55	204.0	0.33	60.1	-	-	-	-	-	-
0.15	540	0.92	681.3	0.59	230.8	0.35	67.9	-	-	-	-	-	-
0.16	576	0.98	765.9	0.63	259.2	0.38	76.2	0.24	26.1	-	-	-	-
0.18	648	1.11	948.9	0.71	320.4	0.43	94.0	0.27	32.2	-	-	-	-
0.20	720	1.23	1150.1	0.79	387.6	0.47	113.5	0.30	38.8	-	-	-	-
0.22	792	1.35	1369.3	0.86	460.6	0.52	134.7	0.33	46.0	-	-	-	-
0.24	864	1.47	1606.4	0.94	539.4	0.57	157.5	0.36	53.7	-	-	-	-
0.26	936	-	-	1.02	623.9	0.62	181.8	0.39	61.9	-	-	-	-
0.28	1008	-	-	1.10	714.2	0.66	207.8	0.42	70.7	-	-	-	-
0.30	1080	-	-	1.18	810.1	0.71	235.4	0.45	80.0	0.29	27.5	-	-
0.35	1260	-	-	1.38	1074.6	0.83	311.3	0.53	105.5	0.34	36.2	-	-
0.40	1440	-	-	-	-	0.95	396.8	0.61	134.3	0.39	46.0	-	-
0.45	1620	-	-	-	-	1.06	491.9	0.68	166.1	0.44	56.8	-	-
0.50	1800	-	-	-	-	1.18	596.4	0.76	201.0	0.49	68.7	-	-
0.60	2160	-	-	-	-	1.42	833.7	0.91	280.1	0.58	95.4	0.36	30.7
0.70	2520	-	-	-	-	-	-	1.06	371.1	0.68	126.1	0.42	40.4
0.80	2880	-	-	-	-	-	-	1.21	474.0	0.78	160.8	0.49	51.4
0.90	3240	-	-	-	-	-	-	-	-	0.87	199.2	0.55	63.6
1.00	3600	-	-	-	-	-	-	-	-	0.97	241.5	0.61	77.0
1.10	3960	-	-	-	-	-	-	-	-	1.07	287.5	0.67	91.5
1.20	4320	-	-	-	-	-	-	-	-	1.17	337	0.73	107
1.30	4680	-	-	-	-	-	-	-	-	1.26	391	0.79	124
1.40	5040	-	-	-	-	-	-	-	-	1.36	448	0.85	142
1.50	5400	-	-	-	-	-	-	-	-	-	-	0.91	161
1.60	5760	-	-	-	-	-	-	-	-	-	-	0.97	181
1.80	6480	-	-	-	-	-	-	-	-	-	-	1.09	225
2.00	7200	-	-	-	-	-	-	-	-	-	-	1.21	273
2.20	7920	-	-	-	-	-	-	-	-	-	-	1.34	326
2.40	8640	-	-	-	-	-	-	-	-	-	-	1.46	382
2.60	9360	-	-	-	-	-	-	-	-	-	-	-	-

Tab. 06-4 Pressure loss table for SDR 7.4 carrier pipes at 80 °C

Recommended layout area for REHAU SDR 11 carrier pipes with REHAU jointing technique:

	Compression sleeve jointing technique recommended
--	---

	maximum possible velocity for compression sleeve jointing technique
--	---

	(max. velocity with partly very high pressure drop (Pa/m) → no longer recommended in the critical path)
--	---

06.04 Heat losses RAUTHERMEX and RAUVITHERM pipes

At a ground temperature of 10 °C, a conductivity of the ground of 1.0 W/m·K, a depth of 0.8 m and a pipe spacing of 0.1 m, the following heat losses occur at the respective average operating temperature per pipe metre. The specified heat losses apply for 1 m RAUTHERMEX or RAUVITHERM pipe. In this context, the heat losses in one DUO pipe are 30% lower compared to two UNO pipes (see Fig. 06-18 and Fig. 06-19).

Calculation assumptions:

- Installation type UNO pipe: 2 pipes below ground
- Installation type DUO pipe: 1 pipe below ground
- Pipe spacing for UNO pipe: a = 0.1 m
- Pipe cover: h = 0.8 m
- Soil temperature: $\vartheta_E = 10\text{ °C}$
- Conductivity of the ground: $\lambda_E = 1.0\text{ W/m}\cdot\text{K}$
- Conductivity of the PUR foam RAUTHERMEX ★: $\lambda_{PU} \star = 0.0199\text{ W/m}\cdot\text{K}$
- Conductivity of the PE-Xa pipe: $\lambda_{PE-Xa} = 0.38\text{ W/m}\cdot\text{K}$
- Conductivity of the PE pipe jacket: $\lambda_{PE} = 0.33\text{ W/m}\cdot\text{K}$

Energy losses during operation

$\dot{Q} = U (\vartheta_B - \vartheta_E) \text{ [W/m]}$
 $U = \text{thermal heat transfer coefficient [W/m}\cdot\text{K]}$
 $\vartheta_B = \text{average operating temperature [°C]}$
 $\vartheta_E = \text{soil temperature [°C]}$

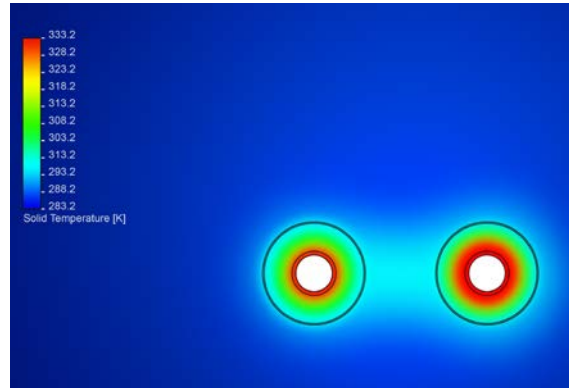

Fig. 06-18 Heat distribution for UNO pipes

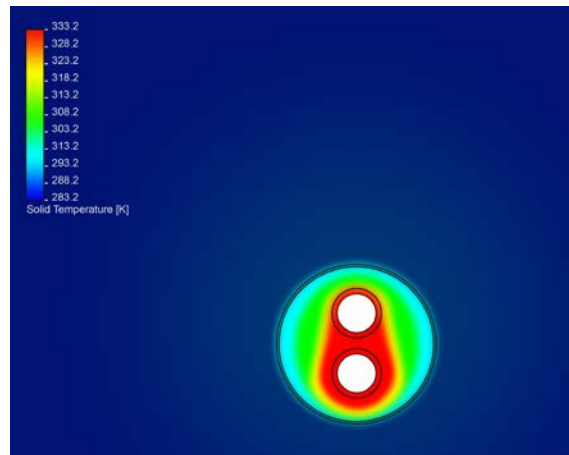

Fig. 06-19 Heat distribution for DUO pipes

Example of heat loss for the dimension of RAUTHERMEX UNO 63/126

- Flow temperature: $\vartheta_V = 80\text{ °C}$
- Return temperature: $\vartheta_R = 60\text{ °C}$
- Average operating temperature: $\vartheta_B = (80\text{ °C} + 60\text{ °C})/2 = 70\text{ °C}$
- Read heat loss: $\dot{Q} = 9.7\text{ W/m}$
- (Tables on the following pages)
- Heat loss with regard to the flow and return: $\dot{Q} = 2 \times 9.7\text{ W/m} = 19.4\text{ W/m}$

RAUTHERMEX UNO SDR 11

Type	Heat losses Q/metre[W/m] average operating temperature ϑ_B					
	30 °C	40 °C	50 °C	60 °C	70 °C	80 °C
25/91	2 x 1.8	2 x 2.7	2 x 3.6	2 x 4.6	2 x 5.5	2 x 6.4
...
63/126	2 x 3.2	2 x 4.9	2 x 6.5	2 x 8.1	2 x 9.7	2 x 11.3
...

Tab. 06-5 Example of heat loss, original table see page 64



For every metre of the pipe run, the heat losses are calculated based on flow and return, for example:
 $\dot{Q} = 2 \times 9.7\text{ W/m} = 19.4\text{ W/m}$

For DUO pipes, the heat loss can be read directly. The factor of 2 (for flow and return) is not required.

Heat losses \dot{Q}

RAUTHERMEX UNO SDR 11 \oplus

Type	Heat losses \dot{Q} /metre[W/m] average operating temperature \bar{t}_B					
	30 °C	40 °C	50 °C	60 °C	70 °C	80 °C
25/91	2 x 1.8	2 x 2.7	2 x 3.6	2 x 4.6	2 x 5.5	2 x 6.4
32/91	2 x 2.2	2 x 3.3	2 x 4.4	2 x 5.6	2 x 6.7	2 x 7.8
32/111	2 x 1.9	2 x 2.9	2 x 3.8	2 x 4.8	2 x 5.8	2 x 6.7
40/91	2 x 2.8	2 x 4.1	2 x 5.5	2 x 6.9	2 x 8.3	2 x 9.7
40/126	2 x 2.0	2 x 3.1	2 x 4.1	2 x 5.1	2 x 6.1	2 x 7.1
50/111	2 x 2.8	2 x 4.3	2 x 5.7	2 x 7.1	2 x 8.5	2 x 9.9
50/126	2 x 2.5	2 x 3.8	2 x 5.0	2 x 6.3	2 x 7.6	2 x 8.8
63/126	2 x 3.2	2 x 4.9	2 x 6.5	2 x 8.1	2 x 9.7	2 x 11.3
63/142	2 x 2.8	2 x 4.3	2 x 5.7	2 x 7.1	2 x 8.5	2 x 9.9
75/162	2 x 3.0	2 x 4.5	2 x 6.0	2 x 7.5	2 x 8.9	2 x 10.4
90/162	2 x 3.8	2 x 5.7	2 x 7.6	2 x 9.5	2 x 11.4	2 x 13.3
90/182	2 x 3.2	2 x 4.8	2 x 6.5	2 x 8.1	2 x 9.7	2 x 11.3
110/162	2 x 5.5	2 x 8.2	2 x 11.0	2 x 13.7	2 x 16.4	2 x 19.2
110/182	2 x 4.4	2 x 6.5	2 x 8.7	2 x 10.9	2 x 13.1	2 x 15.3
110/202	2 x 3.7	2 x 5.6	2 x 7.4	2 x 9.3	2 x 11.1	2 x 13.0
125/182	2 x 5.6	2 x 8.4	2 x 11.2	2 x 14.0	2 x 16.8	2 x 19.6
125/202	2 x 4.6	2 x 6.9	2 x 9.2	2 x 11.5	2 x 13.7	2 x 16.0
140/202	2 x 5.8	2 x 8.7	2 x 11.6	2 x 14.5	2 x 17.3	2 x 20.2
160/250	2 x 6.1	2 x 9.1	2 x 12.1	2 x 15.1	2 x 18.2	2 x 21.2

Tab. 06-6 Heat losses RAUTHERMEX UNO, SDR 11

RAUTHERMEX DUO SDR 11 \oplus

Type	Heat losses \dot{Q} /metre[W/m] average operating temperature \bar{t}_B					
	30 °C	40 °C	50 °C	60 °C	70 °C	80 °C
20+20/111	2.1	3.2	4.3	5.3	6.4	7.5
25+25/111	2.6	3.9	5.1	6.4	7.7	9.0
32+32/111	3.4	5.1	6.8	8.5	10.1	11.8
32+32/126	2.9	4.3	5.7	7.2	8.6	10.0
40+40/126	3.8	5.7	7.6	9.5	11.5	13.4
40+40/142	3.2	4.8	6.4	8.0	9.6	11.2
50+50/162	3.6	5.3	7.1	8.9	10.7	12.5
50+50/182	3.0	4.5	6.0	7.6	9.1	10.6
63+63/182	4.3	6.4	8.5	10.7	12.8	14.9
63+63/202	3.6	5.3	7.1	8.9	10.7	12.5
75+75/202	4.9	7.3	9.7	12.2	14.6	17.0

Tab. 06-8 Heat losses RAUTHERMEX DUO, SDR 11



RAUVITHERM UNO SDR 11 \oplus

Type	Heat losses \dot{Q} /metre[W/m] average operating temperature \bar{t}_B					
	30 °C	40 °C	50 °C	60 °C	70 °C	80 °C
25/120	2 x 3.3	2 x 4.9	2 x 6.5	2 x 8.2	2 x 9.8	2 x 11.4
32/120	2 x 3.8	2 x 5.7	2 x 7.6	2 x 9.5	2 x 11.4	2 x 13.3
40/120	2 x 4.5	2 x 6.7	2 x 8.9	2 x 11.2	2 x 13.4	2 x 15.6
50/150	2 x 4.5	2 x 6.8	2 x 9.0	2 x 11.3	2 x 13.5	2 x 15.8
63/150	2 x 5.5	2 x 8.3	2 x 11.1	2 x 13.8	2 x 16.6	2 x 19.4
75/175	2 x 5.7	2 x 8.5	2 x 11.4	2 x 14.2	2 x 17.0	2 x 19.9
90/175	2 x 6.8	2 x 10.2	2 x 13.5	2 x 16.9	2 x 20.3	2 x 23.7
110/190	2 x 8.2	2 x 12.2	2 x 16.3	2 x 20.4	2 x 24.5	2 x 28.6
125/210	2 x 8.5	2 x 12.7	2 x 16.9	2 x 21.2	2 x 25.4	2 x 29.6
140/220	2 x 10.0	2 x 15.1	2 x 20.1	2 x 25.1	2 x 30.1	2 x 35.1
160/240	2 x 11.0	2 x 16.6	2 x 22.1	2 x 27.6	2 x 33.1	2 x 38.6

Tab. 06-7 Heat losses RAUVITHERM UNO, SDR 11

RAUVITHERM DUO SDR 11 \oplus

Type	Heat losses \dot{Q} /metre[W/m] average operating temperature \bar{t}_B					
	30 °C	40 °C	50 °C	60 °C	70 °C	80 °C
25+25/150	4.9	7.4	9.8	12.3	14.7	17.2
32+32/150	5.2	7.8	10.4	13.0	15.5	18.1
40+40/150	6.4	9.6	12.8	16.1	19.3	22.5
50+50/175	6.7	10.1	13.4	16.8	20.2	23.5
63+63/210	7.7	11.5	15.4	19.2	23.0	26.9

Tab. 06-9 Heat losses RAUVITHERM DUO, SDR 11



RAUTHERMEX UNO SDR 7.4 plumbing 

Type	Heat losses Q /metre [W/m] average operating temperature ϑ_b				
	30 °C	40 °C	50 °C	60 °C	70 °C
20/76	2 x 2.1	2 x 3.1	2 x 4.1	2 x 5.2	2 x 6.2
25/76	2 x 2.4	2 x 3.7	2 x 4.9	2 x 6.1	2 x 7.3
32/76	2 x 3.2	2 x 4.8	2 x 6.4	2 x 7.9	2 x 9.5
40/91	2 x 3.3	2 x 5.0	2 x 6.7	2 x 8.3	2 x 10.0
50/111	2 x 3.4	2 x 5.1	2 x 6.9	2 x 8.6	2 x 10.3
63/126	2 x 3.9	2 x 5.9	2 x 7.8	2 x 9.8	2 x 11.7

Tab. 06-10 Heat losses RAUTHERMEX UNO, SDR 7.4

**RAUTHERMEX DUO SDR 7.4 plumbing** 

Type	Heat losses Q /metre [W/m] average operating temperature ϑ_b				
	30 °C	40 °C	50 °C	60 °C	70 °C
25+20/91	3.4	5.1	6.9	8.6	10.3
32+20/111	3.2	4.8	6.4	8.0	9.7
40+25/126	3.5	5.3	7.1	8.9	10.6
50+32/126	5.0	7.4	9.9	12.4	14.9

Tab. 06-11 Heat losses RAUTHERMEX DUO, SDR 7.4

Information on the heat losses of the pipe range
"RAUTHERMEX strong for district heating SDR 7.4"
is available upon request.

06.05 Temperature and pressure limits

The following pressure limits apply for REHAU SDR 11 carrier pipes for the RAUVITHERM and RAUTHERMEX pipe systems over the maximum service life depending on a continuous operating temperature and operating duration:

Operating temperature [°C]	Safety factor SF depending on the temperature	Permissible operating pressure [bar]	Min. service life D_i [years]
50	1.5	8.7	100
55	1.5	8.2	100
60	1.5	7.8	100
65	1.5	7.3	100
70	1.5	6.9	95
75	1.5	6.6	55
80	1.5	6.3	32
85	1.3	6.9	19
90	1.3	6.3	11
95	1.3	6.3	7

Tab. 06-12 Temperature and pressure limit

In this way the minimum requirements on the long-term properties according to DIN 16892/93 (2019 issue) and the additional higher requirements in accordance with DIN EN 15632 (2015 issue) are fully met. The permitted operating pressures are based on a safety factor as per the Chapter 03. Corresponding reference measurements are taken regularly by external testing institutes and the longterm hydrostatic pressure resistance is verified.



Fig. 06-20 In the endurance test, the pipes are tested for their temperature and pressure resistance



Fig. 06-21 Pipes and jointing technique are tested as a system

06.06 Service life calculation with the Miner's rule

In practice, a heat network is operated with changing flow and return temperatures T_1 to T_n in a so-called load profile. The resulting service life of the REHAU PE-Xa carrier pipe can then be calculated according to ISO 13760 using the Miner's rule.

Examples of the service life calculation

In the following examples, different service lives for different load profiles are specified.

- Example 1:
Heating network operated over the entire year at a constant 80 °C flow temperature

- Example 2:
Heating network with flow temperature floating between 65–85 °C, depending on the outside temperature
- Example 3:
Heating network for partly supplying an industrial consumer at 85 °C flow temperature with up/down ramp
- Example 4:
Low-temperature heating network with flow temperature of 55–60 °C

The maximum operating pressure is set at 6 bar. The calculation in each network only considers the flow leg that is subjected to a higher thermal load. The colder return pipe always has a longer service life.

Operating temperature [°C]	Service life at a continuous operation [years]	Example 1 Annual operating life [h]	Example 2 Annual operating life [h]	Example 3 Annual operating life [h]	Example 4 Annual operating life [h]
50	100	0	0	185	0
55	100	0	0	160	4380
60	100	0	0	145	4380
65	100	0	504	130	0
70	95	0	3720	120	0
75	55	0	840	115	0
80	32	8760	3528	110	0
85	19	0	168	4500	0
90	11	0	0	0	0
95	7	0	0	0	0
Total operating time (h/a)		8760	8760	5280	8760
Resulting service life		32 years	> 50 years	> 30 years	> 100 years

This means that the service life of a pipe in a heat network with a floating temperature profile is significantly higher than the service life in a continuous constant operation at the maximum temperature.



REHAU provides you with project-specific service life calculations as a support for planning. Please contact your REHAU sales contact person, see "REHAU Sales Offices" on page 102.

06.07 Connection questionnaire for a district heating network

The connection questionnaire (see appendix) is the key tool in the pre-planning phase, as it provides initial connection point data that can be used for pre-dimensioning. Here, the main focus is on information about heat consumption, building data and data on the existing energy centre along with the general readiness for connection. The spatial distribution of the connections and the distribution density can therefore be calculated easily for an initial cost-effectiveness evaluation of the heating network.

In the detailed planning, the connection questionnaires can also be used for the basic data collection.

Fig. 06-22 Connection questionnaire

06.08 Project questionnaire for a district heating network

The object questionnaire (see appendix) is used to request data relevant to the planning of a heating network. The most important data for the dimensioning can be collected here

- Object location
- Location plan
- Consumers with connection outputs
- Network design temperatures
- Other specifications, for example, height differences between the energy centres and the highest point in the network.

Fig. 06-23 Project questionnaire



With the REHAU in-house design centre, REHAU is available at any time to assist you when dimensioning and designing your heating network. For contact persons see "REHAU Sales Offices" on page 102.

07 Installation of heat network



07.01 Transport and storage



Incorrect transport or storage can result in damage to pipes, accessories and fittings, which could impact the operational safety, particularly on the excellent thermal insulation properties. Pipes and pipeline components should be checked for any transportation and/or storage damage before being placed in the trench. Damaged pipes and pipeline components must not be installed. Due to the coiling of the pipes, irregular corrugations can occur on the inside of the pipe, which generally do not impair the pipe quality. These disappear once the pipes have been installed.

Storage period

To prevent foreign material penetrating the pipes and damage to the carrier pipe from UV radiation, the pipe ends of the REHAU district heating pipes must be kept sealed. Contact with potentially damaging substances (see Supplement 1 to DIN 8075) should be avoided. REHAU pipes can only be stored in direct sunlight for a limited time. Experience has shown that in Central Europe pipes can be stored outside for up to 2 years after manufacture without affecting the strength of the pipes. For prolonged periods of storage outside or in areas with intense solar radiation, e.g. at the sea, in southern countries or at altitudes over 1500 m, the pipes must be protected from sunlight. When covering with tarps, check the UV resistance of the tarps and ensure there is good ventilation to prevent any built up of heat. Unlimited storage is possible if the pipes are protected from any light.

Lifting with a forklift

When using a forklift, ensure that the forks are covered with a suitable protective material (e.g. plastic pipes) to prevent damage to the pipe coil.



When using plastic pipes, make sure they are secured properly to prevent them from slipping off.

**Warehouse****Transport**

Pipe coils are to be transported horizontally, lying completely flat on a load area, and must be secured to prevent shifting. The load area must be cleaned before loading up the pipe coils.

**Lifting with a digger**

For lifting, make use of at least 50 mm wide lifting slings or straps. Do not use ropes or chains. When lifting a horizontal pipe coil for vertical transport, ensure that the lower part of the coil, which is still touching the ground and carrying part of the total weight, is not dragged across the ground or load area.

Take extra care when putting down the pipe coils.

**Storage**

We recommend storing pipe coils horizontally on wooden planks. This will largely avoid any pipe damage and allow easy lifting of the pipe coils when moved at a later stage. Under no circumstances are pipe coils to be stored on top of sharp-edged objects.

**Risk of injury due to the pipe coil falling over**

It is also possible to store pipe coils upright. In this case, it is necessary to secure them against falling over and rolling.

If stored vertically, the weight pressure on the relatively small supporting surface can press objects into the outer jacket. It must be ensured that the ground area is suitable for storage.



07.02 Installation methods

07.02.01 General information

Notes about pipe trenches

The width at the bottom of the trench depends on the external diameter of the pipe and also whether or not any access space is required for laying the pipes. It is to be noted that the dimensions of the pipe trench influence the size and distribution of the soil and moving loads and therefore the load-bearing capacity of the pipeline.

For REHAU district heating pipes, only in shroud installation areas accessible working spaces are required, these are to be specified in accordance with DIN 4124.

The regular minimum covering over the pipe is 80 cm; the maximum covering is 2.6 m. Larger and smaller coverings must be confirmed by means of a static load calculation.



Generally, the pipes should be installed at a frost-free depth.

Without a traffic load, the minimum covering depth can be reduced to 60 cm (see Section 07.03.01 „Trench widths“), in which case higher heat losses occur and special measures to prevent freezing may have to be employed.

The trench base is to be created with a sand bed (thickness 10 cm, grain size 0/4) in the width and depth in such a way, that the pipe lies across the whole length.



Fig. 07-1 Suitable trench base

The trench base must not be loose. Before the pipes are laid, any loose, cohesive soil is to be removed in its entire depth and be replaced with non-cohesive soil or a special pipe support. Loose, non-cohesive soil must be compacted again.



Fig. 07-2 Trench base with pipe support

Traffic loads

Laying underneath roads must comply with loading classifications SLW 30 (= 300 kN total load) or SLW 60 in accordance with DIN 1072. With the appropriate surface structure according to the guidelines for the standardisation of the surface structure of traffic areas (RStO), the pipes can be driven over with SLW 60, as supported with structural evidence. The pipes have a ring stiffness of SN 4.

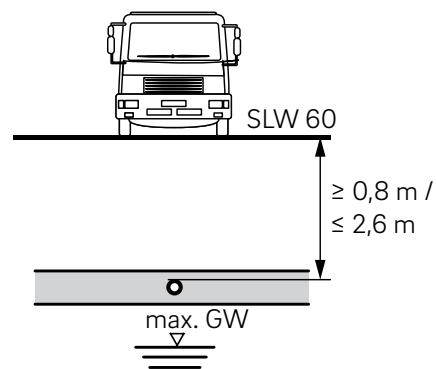

Fig. 07-3 Pipe Cover with moving loads

07.02.02 Open trench installation

The standard installation type is the trench installation. The pipe trenches can be designed to be very narrow here. Sufficient working space only has to be available at the connection points. The process can be carried out for all soil types and by any civil engineering company.



Fig. 07-4 Installation with the trench installation



- Flexible laying without special tools
- Simple and cost-effective
- Additional connections can be made at any time
- Minimum trench width, only increased trench width required in jointing areas for work access



- A complete tarmac track is required in tarmacked areas.
- The pipe is laid into the open trench without any aid.

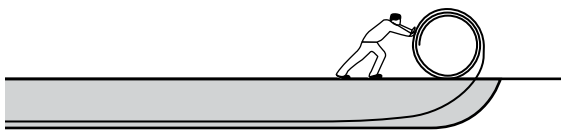

Fig. 07-5 Schematic illustration of open trench installation

07.02.03 Pull-through technique

With the pull-through method, REHAU district heating pipes can be pulled through, for example, disused sewers or empty pipes. In addition there is extra flexibility in open trench installations to pull the heat network pipes underneath crossing sewers, pipes or any other services.



Fig. 07-6 Installation cart



- Cost-effective laying through empty pipes that already exist or have been installed using horizontal directional drilling
- For RAUTHERMEX, high insertion forces can be used due to the composite design. This, in turn, allows large distances to be covered.



- When pulling around sharp edges bend rollers must be used in order to avoid damage to the district heating pipe.
- The internal diameter of the empty pipe must be sufficiently big. An annular gap of at least 2 cm must be considered. When pulling around bends, these must be made up of individual bend fittings no larger than 15°. In this case, the width of the annular gap must also be greater.
- Preferably, a pipe decoiler should be used.
- At both ends of the pull in section the pipes must be adequately secured against any movement (e.g. by embedding them over a sufficient length).

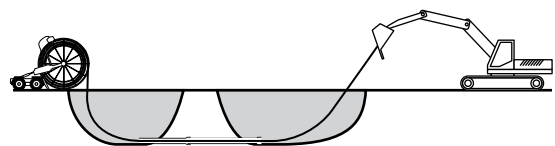

Fig. 07-7 Schematic illustration of pull-through technique

07.02.04 Mole ploughing technique for RAUTHERMEX

Using the mole ploughing technique, the pipes are laid into the ploughed base quickly and without any great effort directly by the mole ploughing machine. The process can be used in largely stone-free soil. For this installation type, a specialist firm is required, and it is only economic above a length of 500 m.



Fig. 07-8 Installation with mole ploughing machine



- No need for pipe trenches
- High installation efficiency possible with up to 5 km per day, depending on the pipe diameter
- Cost-effective installation method for long runs without branch and unsurfaced areas



- The installation is only possible in unsealed areas and with RAUTHERMEX.
- No services must be crossing the pipe run.
- For installations via mole ploughing, special contractors exist with the appropriate equipment and know-how.
- Can only be used in suitable ground conditions.

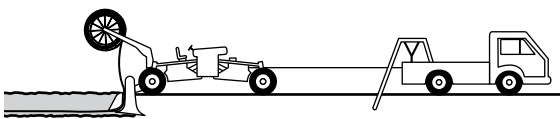

Fig. 07-9 Schematic diagram of mole ploughing technique

07.02.05 Horizontal directional drilling for RAUTHERMEX

With horizontal directional drilling, the drilled-out material is moved out using the rinsing liquid from the borehole. In the opposite direction, the pipe is pulled in below ground. This is used for complex crossings (building, motorway or river crossings). It generally can't be used in sandy or very rocky soil.



Fig. 07-10 Installation with horizontal directional drilling device



- High-quality surfaces can be preserved and bypassed
- Possible to pass beneath water and frequently used roads
- High installation efficiency with over 100 m per day



- Horizontal directional drilling is only possible with RAUTHERMEX.
- The maximum forces that the pipe is subjected to must be below the permitted forces (see Tab. 07-1 „Maximum permitted forces RAUTHERMEX SDR 11“ and Tab. 07-2 „Maximum permitted forces RAUTHERMEX SDR 7.4“).
- The horizontal directional drilling radius depends on the drill pipe, not on the bending radius of the pipe.
- The location of existing supply lines must be known exactly so that these can be avoided.
- Start and end trenches as well as 6–10 m space for the machine will be required.
- Pulling through a protective sleeve that has been inserted previously should be favoured over installation using horizontal directional drilling.

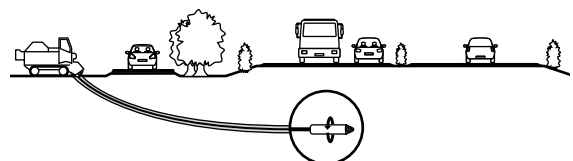

Fig. 07-11 Schematic diagram of horizontal directional drilling

Notes about horizontal directional drilling

The drill head must always be fastened to the RAUTHERMEX pipe at the inner pipe or, in the case of DUO, at both inner pipes and the jacket.

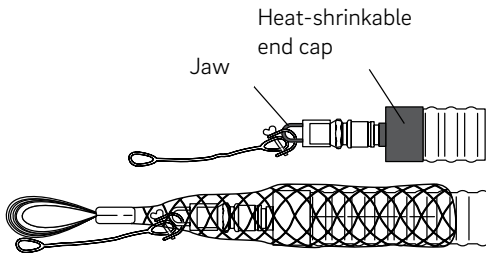

Fig. 07-12 RAUTHERMEX connection – drill head



Fig. 07-13 RAUTHERMEX directional drilling

Maximum permitted force that the pipe can be subjected to:

RAUTHERMEX SDR 11 for use with hot water

Dimensions	Maximum permitted force [kN]
UNO 25	3
UNO 32	5
UNO 40	6
UNO 50	7
UNO 63	9
UNO 75	11
UNO 90	14
UNO 110	16
UNO 125	19
UNO 140	22
DUO 20+20	6
DUO 25+25	7
DUO 32+32	10
DUO 40+40	12
DUO 50+50	15
DUO 63+63	19
DUO 75+75	23

Tab. 07-1 Maximum permitted forces RAUTHERMEX SDR 11

RAUTHERMEX SDR 7.4 for plumbing

Dimensions	Maximum permitted force [kN]
UNO 20	3
UNO 25	4
UNO 32	5
UNO 40	6
UNO 50	8
UNO 63	10
DUO 25+20	7
DUO 32+20	8
DUO 40+25	10
DUO 50+32	12

Tab. 07-2 Maximum permitted forces RAUTHERMEX SDR 7.4

07.03 Trench dimensions and pipe spacing

07.03.01 Trench widths

The figures show the required trench widths.

Only sand of grade 0/4 is to be used in the pipe zone and must be compacted manually in layers.

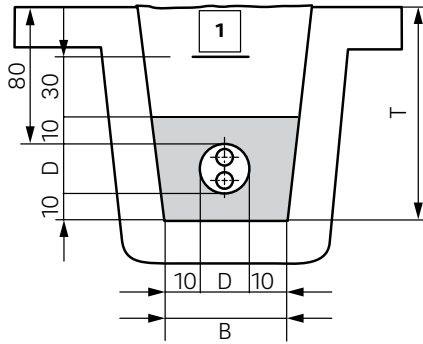

Fig. 07-14 Trench width of individual pipe (UNO/DUO)

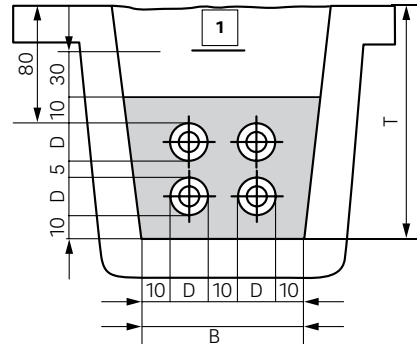

Fig. 07-17 Trench width 4 pipes, variant 1 (UNO/DUO)

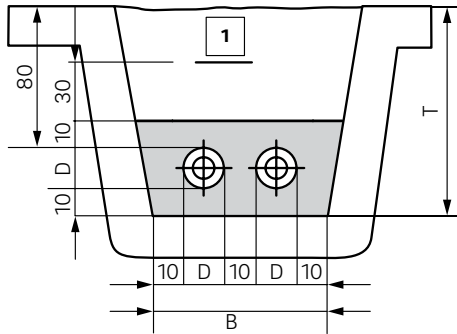

Fig. 07-15 Trench width 2 pipes (UNO/DUO)

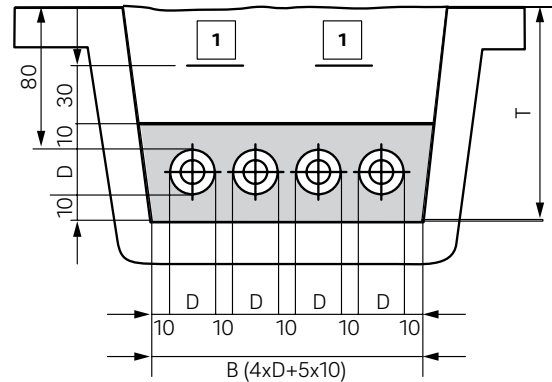

Fig. 07-18 Trench width 4 pipes, variant 2 (UNO/DUO)

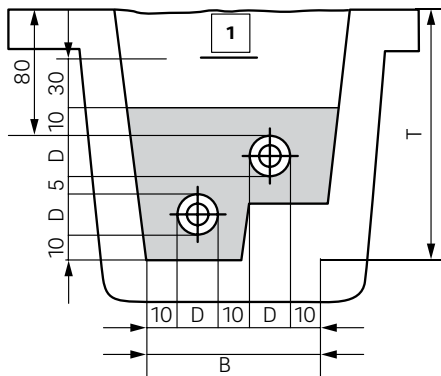

Fig. 07-16 Trench width of stepped trench 2 pipes (UNO/DUO)

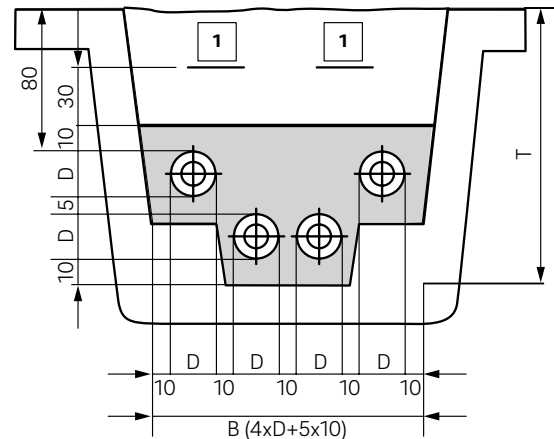

Fig. 07-19 Trench width of stepped trench 4 pipes, (UNO/DUO)

- 1 Identification tape
- B Trench base width
- D Pipe diameter
- T Trench depth



In the area of branch connections with parallel laid pipes, a stepped trench is required over a minimum of 5m.

07.03.02 Proximity to other services

For installations close to supply lines, minimum spacing in accordance with DVGW W 400 must be observed (see Tab. 07-3 „Minimum installation clearance to other supply lines“).

Drinking water lines adjacent to district heating pipes are to be protected against the impermissible heat gain. If this cannot be guaranteed due to the proximity, the drinking water lines are to be insulated or to be protected against heat influences through other measures.

Heat gain can also have a negative effect on electrical cables.

Type of supply line	Parallel line < 5 m/ crossover	Parallel line > 5 m
1 kV, signal, sensor cable	0.3 m	0.3 m
10 kV or a 30 kV cable	0.6 m	0.7 m
Several 30 kV cables	1.0 m	1.5 m
Cable over 60 kV	1.0 m	1.5 m
Gas pipelines	0.2 m	0.4 m
Water lines ¹⁾	1.0 m	1.0 m

¹⁾ In accordance with DVGW W 400, it is to be assumed that "at a distance of at least 1 m to district heating lines and geothermal lines, there is no adverse influence on the drinking water line. At smaller distances, the individual conditions must be particularly evaluated (length of parallelism, temperature, floor and flow conditions)".

Tab. 07-3 Minimum installation clearance to other supply lines

07.03.03 Protecting the pipes in special installation situations



Laying RAUVITHERM and RAUTHERMEX in groundwater or temporary standing water in principle possible, but not recommended due to the expected higher heat losses.

Pipe joints are categorically not allowed in permanent groundwater.

Boggy conditions and marshland

If in boggy conditions and marshland pipes are laid in an area of fluctuating water levels or underneath traffic areas, solid objects below the pipes that could have an effect on the pipe support must be removed. When doing this, it must be ensured that there is a sufficient depth free from such solid objects.

In the case of a non-load-bearing and heavily water-saturated trench base, the pipe must be secured using suitable construction measures, e.g. non-woven material. This also applies if the trench base runs through varying soil types with changing load bearing capacity.

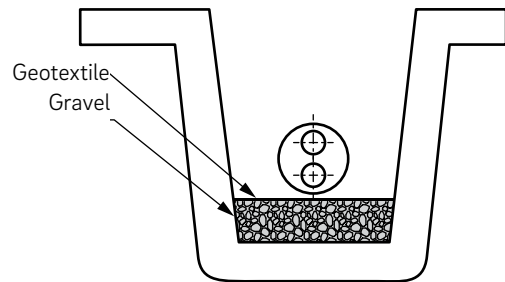

Fig. 07-20 Securing the pipe

Sloped trenches

In sloped trenches, cross brackets are required to prevent the bedding from being washed away. A drain must be provided where necessary.

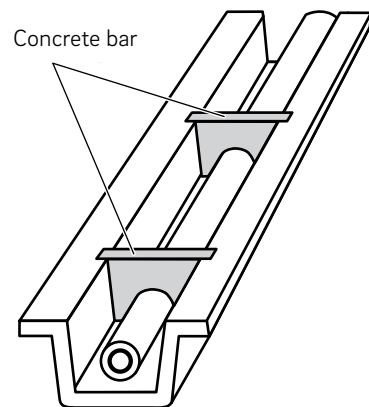

Fig. 07-21 Cross brackets on slopes

07.04 Flexibility

The high flexibility of the REHAU pipes allows easy and quick laying. Obstacles can be bypassed and changes of direction in trenches are possible without the need for fittings. However, the minimum bending radii and bending forces according to the tables in Section 07.05 „Bending radii and bending forces“ are to be observed depending on the pipe temperature.



Fig. 07-22 Passing beneath crossing lines

Where necessary, e.g. laying temperatures below 10 °C or a large pipe diameter, the coils should be warmed up in a heated hall or under a heated tarpaulin.



Fig. 07-23 Changes in direction without fittings



Fig. 07-24 Easy installation thanks to flexible pipe routing

07.05 Bending radii and bending forces

07.05.01 Bending radii

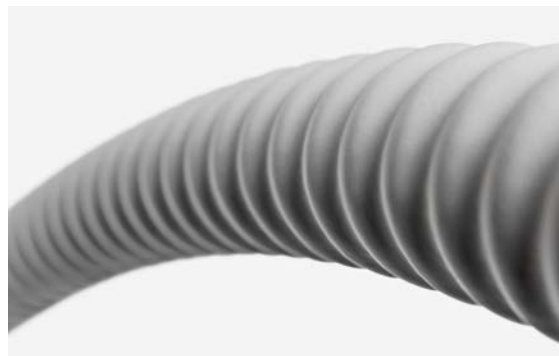

To achieve the bending radii according to Tab. 07-4 / Tab. 07-5 when the pipe jacket is cold, the bend area of the pipe can be warmed up using a low burning flame. When working at freezing point and below, the bend area must generally be preheated.



Damage to the pipes

If the minimum bending radii are ignored, the pipes may kink or can be damaged.

Observe the minimum bending radii, see „Tab. 07-4 Minimum bending radius RAUTHERMEX“ and Tab. 07-5 „Minimum bending radii RAUVITHERM“.



In order to handle the reduced pipe flexibility below 10 °C, the pipe coil can be warmed up for a few hours in a heated hall or under a heated tarpaulin to facilitate installation.

Installation at temperatures below 10 °C is becoming more and more complex. Installation of the pipes is no longer possible at temperatures below –10 °C.

Minimum bending radius RAUTHERMEX

External diameter D	Minimum bending radius R at 10 °C pipe jacket temperature
76 mm	0.50 m
91 mm	0.55 m
111 mm	0.60 m
126 mm	0.65 m
142 mm	0.70 m
162 mm	1.0 m
182 mm	1.2 m
202 mm	1.4 m
250 mm	12.5 m (cut lengths)

Tab. 07-4 Minimum bending radius RAUTHERMEX

Minimum bending radius RAUVITHERM

External diameter D	Minimum bending radius R at 10 °C pipe jacket temperature
120 mm	0.9 m
150 mm	1.0 m
175 mm	1.1 m
190 mm	1.2 m
210 mm	1.4 m

Tab. 07-5 Minimum bending radius RAUVITHERM

Notes about minimum bending radius:

In the case of UNO pipes, with a centrally arranged carrier pipe, the minimum bending radius is considered a technical limit for a bend in any bending direction.

In the case of DUO pipes, with two adjacent carrier pipes, the minimum bending radius is applicable in the direction in which both carrier pipes are bent evenly. In the other direction, DUO pipes can be bent only partially and with much greater effort and much greater bending radii.

The bending forces are the lowest when the bending direction and the coiling direction of the pipe coil in the delivered condition are the same.

07.05.02 Bending forces

The outdoor temperature, the pipe composition as well as the pipe diameter have a major impact on the bending and installation forces. The bending forces required in practice are considerably lower for the RAUVITHERM pipe system than for RAUTHERMEX.

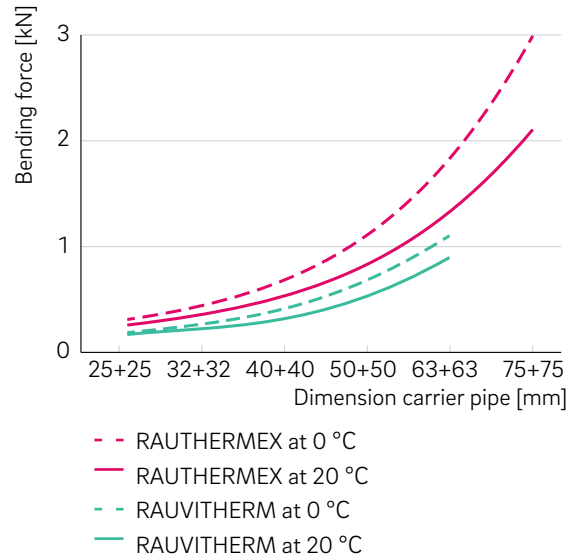

Fig. 07-25 DUO bending forces

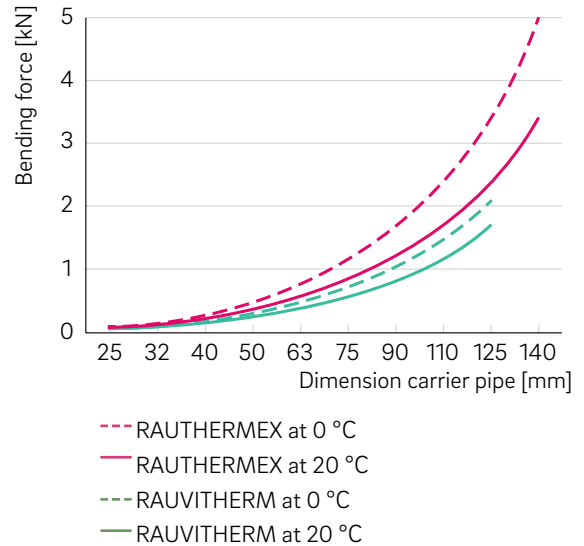

Fig. 07-26 UNO bending forces

07.06 Handling the pipes during installation



Pipes spring back

When undoing the pipe coil straps, pipe ends can spring out!

Do not stand in the danger zone.



Cutting the straps

Always cut straps layer by layer.



Open the coil layer by layer



Kinking risk

Ensure that the uncoiled pipe section does not twist, as otherwise kinks may form.

The straps are therefore to be opened layer by layer and only as far as required. This also makes it easier to unroll them manually.



Uncoiling

For pipes with an external diameter of up to 150 mm, the coil is often unrolled in vertical position directly next to the pipe trench. For larger pipe sizes, we recommend using a mechanical decoiler. For DUO pipes, a horizontal decoiler should be preferably used, as the carrier pipes are then on top of each other even after unwinding, and/or a pipe twisting tool should be used (cf. Section 07.09.03).

Rotating the DUO pipes in a partially backfilled trench is only possible to a limited extent or not at all.

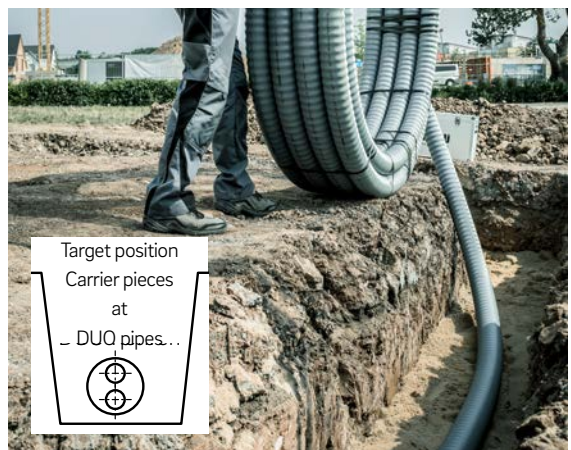

Positioning of the pipes

For DUO pipes, the flow and return must be laid on top of each other so that the branch connections can be made from the side.

For DUO pipes, there is a continuous band printed on one of the two carrier pipes for the allocation (flow or return) of the pipes. It is recommended that the allocation is equal throughout the network or, at least, in larger sections.

For UNO pipes, it is recommended that the installation is done in a stepped trench. This way the branching out can be done to both directions in the entire network. It is also possible to install pipes in a partially made stepped trench, but it may make it more difficult to make subsequent connections.

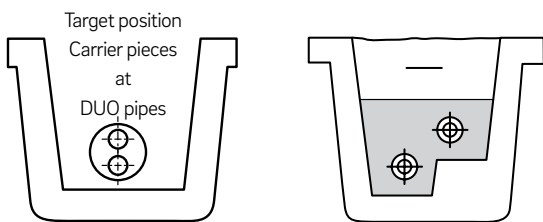

Connection of the carrier pipes

The pipe must be connected prior to filling the pipe trench, in order to have the highest possible mobility of the pipes. For this purpose, the carrier pipes must be laid open and connected using the REHAU compression sleeve technique or FUSAPEX electrofusion coupler technique.



Pressure and leaktightness test

Carry out a leaktightness test of the carrier pipe connections before proceeding further. While doing so, observe the instructions in Section "08 Notes about commissioning and operation" on page 88.

Recording of the pipe network

In order to ensure the future traceability of the network, the installation must be documented in a pipe network plan according to DIN 2425-2. In particular, the allocation of flow and return pipes must be documented. In the case of DUO pipes, a continuous band can be found on one of the two carrier pipes. This can be used to mark in the pipe network plan, which pipe is for flow and which one is for return.

Make shroud connection

Joints in the ground, for example couplings or T-pieces, are to be insulated and sealed to an insulation quality equivalent to that of the pipes. To achieve this, there are two shroud systems. The REHAU clip shroud system and the heat-shrink shroud system (see Section 04.04 and 04.05).



When making the joints, observe the installation instructions of the fitting systems as well as shroud systems "clip shroud" and/or "heat-shrink shroud". You can find these at www.rehau.uk/districtheating.



Deflection of pipes

In the case of couplings and branches, it must be ensured that the ends of the pipes run as straight as possible toward or at right angles to the connections (see image below).

The angle α between the the pipe to be connected and the shroud must not exceed 10° for the REHAU large clip shrouds and 20° for the small clip shrouds and the heat-shrink shrouds.



The best way to align pipes is to support them against the trench wall or by using installation aids. REHAU offers you tools for aligning pipes. See Section 07.09.03 and 07.09.04.

Backfilling pipe trenches

Fill pipe trench up to 10 cm over the top of the pipes using sand of grade 0/4, and compact it by hand.



Apply identification tape

For better identification during future excavation work, lay identification tape 40 cm above the pipes.

The identification tape should be labelled "Caution – District Heating Pipeline".

For easier location of the installed pipeline, identification tape with metallic bands can be used.



Restoring the surface

Backfill the trench and reinstate the original surface.



07.07 Special installation situations

Pipe transitions to custom components/foreign systems

The REHAU jointing technology makes it possible to create connections to common custom components (pre-insulated shut-off valve, Y-piece, welded T-piece, etc.). See also Section 04.01 to Section 04.03.

The universal REHAU heat-shrink shrouds (see Section 04.05) seal the joint reliably. The heat-shrink shroud technology can also be used for smooth outer jackets. After testing the sites' suitability and clarifying any additional requirements, a transition to, for example, pre-insulated steel pipes or other suitable special components can take place.



Fig. 07-27 Pipe transitions

Wall mounting/open installation

In the standard case, district heating pipes are laid below ground, but above ground installation/wall mounting is also possible.

The following are to be observed for open above ground installations or wall mounting:

- Fix pipes with pipe clamps with a spacing of 1 m to prevent lateral displacement by expansion.
- Protect pipes from sunlight, e.g. with a cover plate.
- Take special fire protection measures where necessary.
- Take additional protective measures against freezing where necessary.

- Install fixed points, compensators or expansion bends at the end of a pipe section in order to prevent axial movements or to absorb them in a controlled manner.



Fig. 07-28 Example of above ground / wall mounting



Fig. 07-29 Example of above ground/ wall mounting

As an alternative to our pipe coil systems, our RAUFRIGO FW system provides you with a cut-length system with a wrap-folded outer jacket.

This is often used in industrial systems but also, for example, for the crossing of underground parking.



Fig. 07-30 RAUFRIGO FW

07.08 Tapping into existing lines

07.08.01 Squeeze-off tool

When tapping into existing sections of pipe network of a district heating system that cannot be isolated in the case of repair measures, the carrier pipe can be closed off before and after the point of concern with squeeze-off tools. The medium flow under pressure can be blocked in this way without a pre-insulated shut-off valve.

Squeezing off takes place in accordance with the DVGW guideline GW 332.



Squeezing off should not be carried out at outdoor temperature below 5 °C.

For the squeezing off procedure, observe the "squeezing" installation instructions at

www.rehau.uk/districtheating.



Fig. 07-31 Squeezing off UNO carrier pipes



Fig. 07-32 Squeezing off DUO carrier pipes



Due to the memory effect, the carrier pipe reverts to its original shape after being squeezed. The carrier pipe maintains its mechanical properties at the squeezed point.

Once the tapping or repair work is completed, the squeeze off tool can be opened and removed. The usual operating pressures and temperatures can then be used again with immediate effect. At the usual operating temperatures of district heating networks, the squeezed carrier pipe returns to the original condition very quickly, so that separate suitable with rerounding clamps is usually not necessary.

The distance between the clamps must be fixed during squeezing off, using the limit stop.

Carrier pipe dimension	Spacing of the clamps at the limit stop
25 x 2.3	3.7 mm
32 x 2.9	4.6 mm
40 x 3.7	5.9 mm
50 x 4.6	7.4 mm
63 x 5.8	9.3 mm
75 x 6.8	10.9 mm
90 x 8.2	13.1 mm
110 x 10	16.0 mm
125 x 11.4	18.2 mm
140 x 12.7	20.3 mm
160 x 14.6	23.4 mm

Tab. 07-6 Clamp spacing at a squeezing level of 0.8

The squeezing can also be done for pre-laid pipelines (dead ends).

07.08.02 NEXUS live tapping saddle

The tapping saddle is used for quick, easy and secure branching of the pre-insulated PE-Xa carrier pipes of RAUTHERMEX or RAUVITHERM – during operation, at operating temperatures and maximum operating pressures as per DIN 16892/93.

The tapping saddle is available in the following dimensions of the carrier pipe of the REHAU pipe systems RAUVITHERM and RAUTHERMEX:

- 63
- 75
- 90
- 110
- 125

REHAU NEXUS can be used for the following applications in conjunction with the listed pipe types:

- District heating
- Industrial applications, e.g. high-temperature heating systems up to 95 °C

Compared to the conventional way of making a retrospective connection, the REHAU NEXUS live tapping saddle can be used to forgo very elaborate construction site preparations like draining the network, excavation of large trench lengths or the squeezing of pipes.



Fig. 07-33 NEXUS live tapping saddle



Further technical data on tapping with NEXUS can be found in the Section "04.07.01 REHAU NEXUS" on page 31.

The installation instructions can be obtained from your REHAU Sales Office on request.

07.09 Installation aids

07.09.01 Horizontal decoiler

To unwind the pipe coils easily, even in tight areas, the use of a decoiler is recommended. The pipe coil is fitted to the decoiler and can be unwound horizontally. This pipe decoiler is particularly suited for DUO pipes, as the carrier pipes lie vertically on top of one another in the trench due to the unwinding.

Depending on the basic conditions, the unwinding can be carried out in one of two ways:

Stationary horizontal pipe decoiler

If you have to pass beneath crossing lines, the pipe decoiler can be stationary at the end of the pipe trench, where the pipe can be pulled from into the trench.



Fig. 07-34 Stationary horizontal pipe decoiler at the end of the trench

Mobile horizontal pipe decoiler on a trailer

The unwinding device can be mobile on a trailer and move alongside the trench. The pipe is unwound directly into the trench.

07.09.02 Vertical pipe decoiler



Fig. 07-35 Vertical mobile pipe decoiler

For UNO pipes, a vertical unwinding device can also be used. The pipe coil is put into a cage and unwound from there. The vertical unwinding device is also flexible, as it is used as a trailer.



Fig. 07-36 Vertical mobile decoiler

07.09.03 Pipe twisting tool (DUO pipes)

When connecting DUO pipes, the carrier pipes must not lie horizontally next to each other but vertically on top of each other. As this is not always the case, the pipes must be rotated into the vertical position prior to connection. The pipe twisting tool is used to do this.



Fig. 07-37 Pipe twisting tool

07.09.04 STRAITA installation aid

The REHAU installation aid is a versatile tool for installing REHAU RAUTHERMEX and RAUVITHERM district heating pipes. Its main application is the straightening of pipes to ease the connection of the ends of the pipe. The installation aid can, however, also be used to position pipes.



Fig. 07-38 STRAITA installation aid



Please observe the installation instructions when using the STRAITA installation aid. These can be obtained from your REHAU Sales Office on request.

07.10 Average times for installation and assembly in practice

Indicated times are guide values. These can vary greatly depending on the installation situation. The installation situation covers factors like construction site conditions, weather conditions, individual performance and experience of the fitters, etc.

Laying pipes in open trenches (without groundworks)

	Pipe type	RAUTHERMEX		RAUVITHERM	
		Required work force	Working time (min/m)	Required work force	Working time (min/m)
Incl. crossings, obstacles, machine use for pipe installation (digger, cable winch, etc.), house connection entry	UNO 20, 25, 32, 40	2	3	2	3
	UNO 50, 63	2-3	5	2	4
	UNO 75	2-3	7	2-3	5
	UNO 90, 110, 160	3	10	2-3	8
	UNO 125, 140	3	12	3	10
	DUO 20, 25, 32, 40	2	5	2	4
	DUO 50, 63, 75	2-3	7	2	5

Tab. 07-7 Approximate times for pipe installation

Connecting carrier pipes in open trenches

	Pipe type	RAUTHERMEX		RAUVITHERM	
		Required work force	Working time (min/pc)	Required work force	Working time (min/pc)
Creating a T-branch: Incl. stripping the of pipes, assembling the fittings, compression sleeve pressing, preparing sealing ring or heat-shrink sleeve. Taking into account the use of tools and preparatory and follow-up work typical for a construction site.	UNO 20, 25, 32, 40	2	80	2	50
	UNO 50, 63	2-3	100	2-3	70
	UNO 75	3	140	2-3	100
	UNO 90	3	170	3	120
	UNO 110	3	200	3	150
	UNO 125	4	220	4	170
	UNO 140	4	240	-	-
	DUO 20, 25, 32, 40	2	180	2	150
	DUO 50, 63	3-4	220	3-4	180
	Creating an I/L connection: Incl. stripping the of pipes, assembling the fittings, compression sleeve pressing, preparing sealing ring or heat-shrink sleeve. Taking into account the use of tools and preparatory and follow-up work typical for a construction site.	UNO 20, 25	2	20	2
UNO 32, 40		2	50	2	40
UNO 50, 63		2	75	2	65
UNO 75		2	100	2	80
UNO 90		2-3	110	2	90
UNO 110		3	130	2	100
UNO 125		3-4	160	2- 3	130
UNO 140		3-4	180	-	-
UNO 160		2-3	180	-	-
DUO 20, 25		2	40	2	30
DUO 32, 40	2	100	2	70	
DUO 50, 63, 75	2	150	2	130	

Tab. 07-8 Approximate times for connecting carrier pipes

Completing the wall entry (without wall penetrations or core drill holes)

	Pipe type	RAUTHERMEX		RAUVITHERM	
		Required work force	Working time (min/pc)	Required work force	Working time (min/pc)
Incl. stripping the ends of the pipes, assembling the end fittings or ball valve, setting the labyrinth seal by backfilling with expanding mortar.	UNO 20–50	1	50	1	50
	UNO 63–110	1–2	75	1	65
	UNO 125–140	1	90	1–2	80
	DUO 20–32	1	60	1	50
	DUO 40–75	1	80	1	70

Tab. 07-9 Tab. 02-9 Approximate times for completing the wall entry

Secondary insulation of the pipe connections in the trench

Incl. waiting and cooling times. Taking into account the use of tools and preparatory and follow-up work typical for a construction site	Dimensions	Clip shroud system		Heat-shrink shroud system	
		Required work force	Working time (min/pc)	Required work force	Working time (min/pc)
T-branch incl. secondary insulation	Small	1	45	1	75
	Large	1	50	1	80
I-/L-connection incl. secondary insulation	Small	1	25	1	40
	Large	1	30	1	45

Tab. 07-10 Approximate times for secondary insulation

Fitting custom components

	Pipe type	Clip shroud system		Heat-shrink shroud system	
		Required work force	Working time (min/pc)	Required work force	Working time (min/pc)
Complete assembly Y-pipe	DUO 25–32	2	150	2	150
	DUO 40–50	2–3	310	2	310
	DUO 63–75	3	380	2–3	380
Assembly of the pre-insulated shut-off valve (without backfilling, compacting and protective cover)	UNO 25–50	2	90	2	90
	UNO 63–90	2	200	2	200
	UNO 110–125	3	260	2–3	260
	DUO 25–50	2	140	2	140
	DUO 63–75	2–3	300	2–3	300

Tab. 07-11 Approximate times for fitting custom components



08 Commissioning and operation

08.01 Requirements on heating water

08.01.01 General

The conditions for commissioning and operating warm water heating systems and heating networks have a great influence on the occurrence of corrosion damage and mineral deposits. In order to avoid the damage resulting from this, certain water parameters must be considered and appropriate limit values observed. The piping system must only be operated using the appropriately suited and treated water. During operation, it is imperative to conduct regular checks of the heating water quality.

When using an unsuitable operating medium, various damage can occur.

Deposits

Raw water (drinking water, mains water) more or less contains large quantities of gases and salts that have been dissolved. The carbonate hardness and the overall hardness of the water are the deciding factors for the formation of deposits. Hardness components are hydrogen carbonates as well as calcium and magnesium ions. Particularly with increasing temperatures, precipitation reactions occur that can lead to deposits and blockages in components. Deposits containing iron such as iron oxide and hydroxide (rust) or magnetic iron ore can form in plate heat exchangers or other components.

Corrosion

There are very different types of corrosion and corrosion mechanisms, most of which are triggered chemically. Here, amongst other things, the chemical composition of the heating water as well as the materials used in the system influence the corrosion. The oxygen content plays a central role in the corrosion of metals. Additionally, the pH value (acid concentration), the acid capacity (buffer capacity) as well as the salt content are influencing factors for the occurrence of corrosion.

Guide values for the water quality of the heating water are listed in Tab. 08-1. A differentiation is made here between low-salt and salty methods of operation:

Properties	Unit	Low-salt		Salty
Electrical conductivity at 25 °C	µS/cm	10–30	> 30–100	≥ 100–1,500
Appearance		clear, free from suspended substances		
ph value ¹⁾ at 25 °C		9.0–10.0	9.0–10.5	9.0–10.5
Oxygen ²⁾	mg/l	< 0.1	< 0.05	< 0.02
Hardness ³⁾ (Earth alkalines)	mmol/l	< 0.02	< 0.02	< 0.02
	°dH	< 0.1	< 0.1	< 0.1

1) Depending on the materials used, for ferrous metals corrosion stops at the specified value

2) Oxygen content < 0.1 mg/l, but as low as possible

3) Recommendation Danfoss water quality guide, according to VdTÜV-TCh 1466 Total hardness < 0.1 °dH

Tab. 08-1 Guide values of water quality heating water according to AGFW FW510 or VdTÜV-TCh 1466

08.01.02 Commissioning

Specialist contractors should be commissioned for the preparation of the heating water as well as its testing.

During operation, the water quality in terms of oxygen concentration, pH value and electrical conductivity must always be within the specified range.

If the guide values for the heating water are not observed, appropriate measures are required.

As a salty method of operation is common in practice in the area of district heating, the following recommendations apply. In addition to the measures listed, the state of the art is to be observed.

In particular, it is mandatory to apply the specifications of VDI 2035, extracts of which are mentioned here, and in a manner that fits the system:

- The raw water must be completely softened by using cationic exchangers that can be renewed with table salt (NaCl).
- To achieve the pH value, sodium hydroxide (NaOH) or sodium phosphate (a_2PO_4) should be used.
- In the case of professional planning, installation and regular maintenance and servicing, it is to be assumed that the oxygen content will be set at values below 0.02 mg/l during regular operation of systems that are sealed to prevent corrosion.
- Sodium sulphite (Na_2SO_3) should not be used for oxygen binding, as with the oxygen binding the sulphite is converted into sulphate and then reduced to sulphide by bacteria. This creates a corrosive environment for copper and stainless steel.
- A higher level of oxygenation is not to be expected in underground RAUTHERMEX or RAUVITHERM heating pipes as a result of using REHAU PE-Xa carrier pipes. See also Tab. 03-1 on page 11, row oxygen impermeability.
- Prior to commissioning, the system must be thoroughly flushed with treated or fully softened water.
- The pressure test with fill-up water should take place immediately after flushing.
- Emptying a heating system after a pressure test with raw water should be avoided, as water residue will inevitably be left in parts of the system. The conditions for corrosion reactions are created by the atmospheric oxygen that infiltrates: Small local areas of attack (water line corrosion) form in the area of the three-phase boundary of water/material/air. This initial damage can continue to grow during subsequent operation with the infiltration of oxygen and lead to breaks in the wall. The same processes can also occur in decommissioning with emptying of a heating system or parts of it.
- It is not recommended to only temporarily use water/anti-freeze agent (e.g. in the construction phase), and the subsequent filling with make-up water without anti-freeze should be avoided.

- The professional installation and commissioning of the pressure maintenance is essential as a corrosion protection measure (see also VDI 4708 Sheet 1). This is the most important technical measure to minimise infiltration of oxygen.
- Complete venting of the system is essential to avoid gas pockets and gas bubbles.
- Operational checks with regard to malfunctions, leaks and noises must be carried out following commissioning of the system at the maximum operating temperature.
- The addition of heating water additives (chemicals) is generally only required as a corrosion protection measure in warm water heating systems that have not been sealed against corrosion. The information of the manufacturer of the additive must be noted. Additives can promote the formation of a biofilm.

The commissioning parameters must be documented in a system book (e.g. according to Attachment C VDI 2035 Sheet 2). This system book must be handed over to the system operator following commissioning of the system by the installer or specifier. The operator is responsible for keeping the system book as of this time. The system book is part of the system.

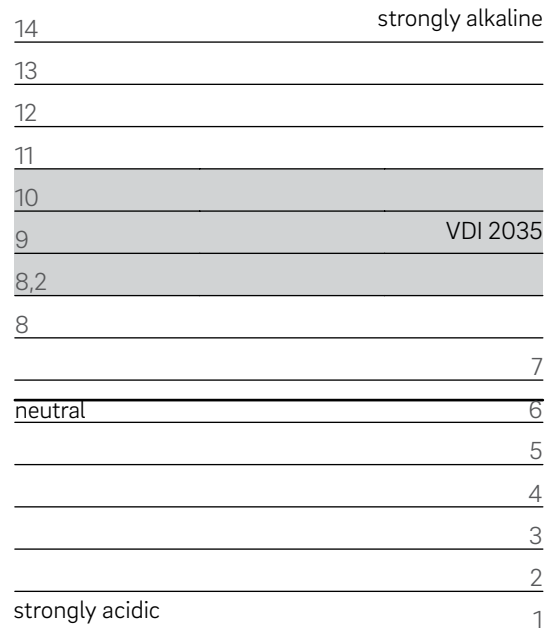

Fig. 08-1 pH value

08.01.03 Operation, maintenance, servicing

Warm water heating systems must be serviced at least once a year. The operator is responsible for the servicing.

The most important operational servicing measure is checking the system pressure, in particular in order to avoid a negative pressure condition with the ingress of oxygen into the heating water of the system.

Not meeting the permitted system pressure during operation is a sign of deficient pressure maintenance or a leak. Appropriate maintenance measures must be carried out.

A shortfall in pressure that is not permitted leads to the formation of gas pockets at the highest point of the system with interruptions to the circulation of the heating water and prevention of heat transfer.

After rectifying the pressure maintenance or leak, the system must be vented and refilled with make-up water.

The following also apply:

- For all systems for which treatment of the fill-up water and top-up water takes place, the conductivity and the pH value must be specified and documented as per manufacturer's specifications and at least once a year. The same applies for systems with more than 600 kW nominal heat output regardless of water treatment.
- If the guide values for conductivity according to Tab. 08-1 on page 88 are exceeded, measures must be taken to reduce the conductivity (e.g. "desludging" the heating water).
- In the case of water treatment, test parameters and the corresponding target value ranges must be specified and documented by the specifier or installer.
- The frequency of the tests as well as the actions required in the case of deviations from the target value range must also be specified by the planner. These must be documented.
- In the case of systems with high topping-up volumes (e.g. over 10% of the system content per year) the cause must be investigated immediately and the defect rectified. It is to be noted that, in the case of a constantly high level of topping up with fill-up and make-up water, an increased probability of corrosion also exists for the components downstream of the inlet point.

08.01.04 Water treatment

Water treatment through the addition of chemicals should be restricted to exceptions.

The selection of water treatment measures and changes to the water treatment requires expert knowledge and should be carried out by specialist firms. All water treatment measures must be accounted for and documented in the system book.

08.01.05 Water sample for external analysis in the laboratory



Scalding hazard

Contact with the escaping heating water can cause serious scalding.

Use suitable protective equipment.

The sample container that is used to collect the water sample must fulfil the following requirements:

- At least 1 litre capacity
- Clean and without chemical residue
- Tightly sealing
- Break-proof (e.g. drinking water PET bottle)
- Can be labelled

The sample must be taken from the main flow of the hydraulics. Dead legs must be emptied accordingly for this purpose:

1. Allow at least two litres of system water to run out of the suitable tap.
2. Fill the sample container completely until it overflows.
3. Seal the sample container tightly.
There should not be any air in the sample container after it has been sealed.
4. Label the sample container properly in order to ensure clear identification of the sample.

08.01.06 Central filter station

The use of a combined mechanical-magnetic filter in the secondary flow allows the particulate matter (magnetite, Cu chips, etc.) to be filtered out during operation. This prevents any disruptions in the heating network (erosion/corrosion, abrasive effect of Cu chips in plastic pipes, additional mechanical stress in the pumps, magnetite deposits in heat exchangers, blockages in the valves). These foreign materials can end up in the district heat network water in particular in heat interface units if repairs are not carried out properly.

Whilst in a large heat network only 5–15% of the total circulation water in the secondary flow is cleaned, in small circuit systems 100% filtration can also be cost-effective. Here it is however to be borne in mind that with the help of an automatic bypass, it is possible to operate the system even with a clogged, full filter.

One solution option according to VDI 2035

Chemical-free water processing using the example of EnwaMatic® (ENWA AS Germany)

Requirement Sheet 1:

- Simple filling of a heating system with appropriately treated water using a cartridge

Requirement Sheet 2:

- Permanent filter grade of 5 µm with automatic backflush
- Self-regulating pH value setting 9–10 for ferrous materials
- Self-reduction of total hardness that is too high
- Bacteria barriers
- Separation of microbubbles

08.02 Pressure and leaktightness test

08.02.01 Principles of the pressure test



Successfully conducting and documenting of a pressure test is the prerequisite for any claims in the framework of the REHAU warranty or assumption of liability agreement with the Central Plumbing, Heating and Air-Conditioning Association (ZVSHK Germany). For safety reasons, only the pressure testing with water is suitable for heating networks. Testing with compressed air is associated with considerable risks due to the high pipe volume and does not provide the necessary validity of the results.

According to DIN EN 806-4 and DIN 1988, prior to commissioning a pressure test must be carried out on the finished but not yet covered pipes (i.e. prior to installation of secondary insulation shrouds).

Statements concerning the leaktightness of the system based on the test pressure course (constant, dropping, increasing) can only be made to certain extent.

- The leak tightness of the system can only be checked by way of a visual inspection of uncovered pipes.
- Small leaks can only be located by way of a visual inspection (escaping water) at high pressure.

Dividing the heating network system into smaller test sections increases the testing accuracy.

08.02.02 Pressure tests with water

Preparing the pressure test with water

1. Pipes must be accessible and must not be covered.
2. Remove safety and metering equipment if necessary and replace it with pipe pieces or pipe end stops.
3. Fill pipes from the lowest point of the system, with air-free filtered filling water. Here, the water temperature must match the ambient temperature ($\Delta\vartheta \leq 10$ K ambient temperature to water temperature)
4. Vent the draw-off points until no air can be determined in the running water.
5. Use a pressure testing device with an accuracy of 100 hPa (0.1 bar) for the pressure testing.
6. Connect the pressure testing device at the lowest point of the heat network.
7. Carefully close all draw-off points.



The pressure testing can be heavily influenced by temperature changes in the pipe system e.g. a temperature modification of 10 K can cause a pressure change of 0.5 to 1 bar.

A pressure fluctuation can arise during the pressure test due to the pipe material properties (e.g. pipe expansion due to increasing pressurisation).

The test pressure as well as the pressure progression during the test do not allow for sufficient conclusions to be drawn regarding the leaktightness of the system. The entire installation, as stipulated in the standards, is therefore to be checked for leaktightness by way of a visual inspection.

8. Make sure that the temperature remains as constant as possible during the pressure test.
9. Prepare the pressure testing report (see page 93) and note the system data.

Pressure test for systems with RAUTHERMEX or RAUVITHERM pipes

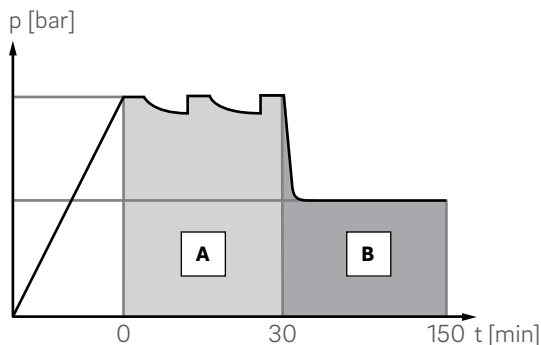

Fig. 08-2 Pressure test diagram for RAUTHERMEX and RAUVITHERM pipes according to the ZVSHK code of practice

- A** Adaptation time (repressurise where necessary)
- B** Pressure test for systems with RAUTHERMEX and RAUVITHERM pipes

1. Build up the test pressure (= 1.1 x max. operating pressure) slowly in the installation.
Example: Test pressure
 $1.1 \times 6 \text{ bar (at } 80 \text{ °C)} = 6.6 \text{ bar}$
2. Maintain the test pressure for 30 minutes.
Build up the test pressure again where necessary.
3. Note down the test pressure in the pressure testing report after 30 minutes.
4. Verify the watertightness of the entire installation, particularly the connecting points, by means of a visual check.

5. Slowly reduce the test pressure to 0.5 x maximum test pressure and note down the test pressure in the pressure testing report.
Example: lowered test pressure
 $0.5 \times 6.6 \text{ bar} = 3.3 \text{ bar}$
6. Read the test pressure after 2 hours and note it down in the pressure testing report.
Verify the watertightness of the entire installation, particularly the connecting points, by means of a visual check.
In the event that the test pressure has dropped:
 - Carry out another detailed visual inspection of the pipes, draw-off points and connecting points.
 - After rectifying the cause of the drop in pressure, repeat the pressure test on the system (steps 1–7).
7. If no leaks have been found during the visual inspection, the leaktightness test can be concluded.

Concluding the pressure test with water

Following conclusion of the pressure test:

1. The company that performed the test and the client must confirm the pressure test in the pressure testing report.
2. Remove the pressure testing device.
3. Re-attach the removed safety and metering equipment.

08.02.03 Pressure test certificate

Pressure test certificates can be sent to you on request, or you can use the template below.

Pressure test certificate: RAUTHERMEX and RAUVITHERM system pipes

Testing based on the ZVSHK code of practice

Pressure test with water

1. Installation details

Building project: _____

Client: _____

Building number, street: _____

Postcode/town: _____

The fill-up water is filtered, the pipe systems are fully vented.

The permitted operating pressure is _____ bar

Water temperature $\vartheta_W =$ _____ °C ambient temperature $\vartheta_U =$ _____ °C

$\Delta\vartheta = \vartheta_U - \vartheta_W =$ _____ K

2. Pressure testing

Step 1:

$\Delta\vartheta \leq 10$ K ambient temperature to fill temperature

Test pressure _____ bar (1.1 x max. operating pressure, e.g. 1.1 x 6.0 bar = 6.6 bar)

Waiting time _____ min. (at least 30 minutes); maintain test pressure, i.e. build up again regularly

Pressure after 30 min. _____ bar

Entire installation, in particular connecting points, tested for leaktightness by way of a visual inspection and no leaks discovered.

Step 2:

Test pressure _____ bar (0.5 x maximum test pressure, e.g. 0.5 x 6.6 bar = 3.3 bar)

Testing time _____ min. (120 min.)

Pressure after 120 min. _____ bar

3. Comments on a test

In Step 2 of the pressure test, no fall in pressure was evident on the manometer.

The entire installation is leaktight.

4. Confirmation

For the customer: _____

For the contractor: _____

Place: _____ Date: _____

Attachments: _____

Standards and guidelines

§

Observe all applicable national and international regulations relating to laying, installation, safety and the prevention of accidents when installing pipe systems as well as the instructions in this Technical Information.

Also observe the applicable laws, standards, guidelines and regulations (e.g. DIN, EN, ISO, DVGW, TRGI, VDE and VDI) as well as regulations on environmental protection, regulations of the Employer's Liability Insurance Association and specifications of the local public utilities companies.

Application areas which are not covered by this Technical Information (special applications) require consultation with our Technical Applications Department.

For more detailed consulting support, please contact your REHAU Sales Office.

The planning and installation instructions relate directly to the relevant REHAU product. At points, we will refer to generally applicable standards or regulations.

Please observe the valid status of the guidelines, standards and regulations.

More in-depth standards, regulations and guidelines relating to the design, installation and operation of district heating networks must also be taken into account and do not form part of this Technical Information.

General

AGFW FW 420

Flexible district heating piping systems – components for systems with polymer medium pipes

ASTM C 1113

Standard Test Method for Thermal Conductivity of Refractories by Hot Wire (Platinum Resistance Thermometer Technique)

BGA KTW

Health assessment of plastics and other non-metallic materials within the framework of the law for foods and commodity goods for potable water applications

DIN 2425, Part 2

Plans for public supplies, for water engineering and for transmission lines; plans for pipe-systems for distant-heating

DIN 4102

Fire behaviour of building materials and building components

DIN 4726

Warm water surface heating systems and radiator connecting systems – Plastics piping systems and multilayer piping systems

DIN 16892

Crosslinked polyethylene (PE-X) pipes – General quality requirements, testing

DIN 16893

Crosslinked polyethylene (PE-X) pipes – Dimensions

DIN 53420

Testing of cellular materials – Determination of apparent density

DIN 53428

Testing of cellular materials – Determination of the resistance to liquids, vapours, gases and solid materials

DIN 53577

Determination of compression stress value and compression stress-strain characteristic for flexible cellular materials

DIN EN 253

District heating pipes – Bonded single pipe systems for directly buried hot water networks

DIN EN 15632
District heating pipes – Pre-insulated flexible pipe systems

DIN EN ISO 13760
Plastics pipes for the conveyance of fluids under pressure – Miner's rule – Calculation method for cumulative damage

DIN EN ISO 15875
Plastics piping systems for hot and cold water installations – Crosslinked polyethylene (PE-X)

DVGW guideline GW 332
Squeezing pipes made from polyethylene in gas and water supply

DVGW standard W 270
Microbial enhancement on materials to come into contact with drinking water – Testing and assessment

DVGW standard W 400
Technical rules for water supply systems

DVGW standard W 531
Manufacture, quality assurance and testing of pipes made of VPE for drinking water installation

DVGW standard W 534
Pipe connector and pipe connections in drinking water installations

DVGW standard W 544
Plastic pipes in drinking water installation

ISO 1183
Plastics – Methods for determining the density of non-cellular plastics

ISO 11357-3
Plastics – Differential scanning calorimetry (DSC) – Part 3: Determination of temperature and enthalpy of melting and crystallization

ISO 1183
Plastics – Methods for determining the density of non-cellular plastics

Planning and installation

DIN 1055
Action on structures

DIN 4124
Excavations and trenches – Slopes, planking and strutting breadths of working spaces

DIN 8075
Polyethylene (PE) pipes – PE 80, PE 100 – General quality requirements, testing

DIN EN 12831
Heating systems in buildings – Method for calculation of the design heat load

DIN V 4701
Energy efficiency of heating and ventilation systems in buildings

Commissioning

AGFW Worksheet FW 510
Requirements for circulation water in industrial and district heating systems and recommendations for their operation

DIN 1988
Codes of practice for drinking water installations

DIN 18380 (VOB)
German construction contract procedures (VOB) – Part C: General technical specifications in construction contracts (ATV) – Installation of central heating systems and hot water supply systems

DIN EN 806
Specifications for installations inside buildings conveying water for human consumption

DIN EN 1264
Water based surface embedded heating and cooling systems

VDI 2035
Prevention of damage in water heating installations – Scale formation and water-side corrosion

VDI 4708
Pressure maintenance, venting, deaeration

VdTÜV-TCh 1466
Richtwerte für das Kreislaufwasser von Heißwasseranlagen [Guide values for recirculated water in hot water systems]

ZVSHK code of conduct leaktightness testing of drinking water installations with compressed air, inert gas or water

REHAU Service



Service via all channels



Advice (technical support)

We can already in the early stages of your project discuss with you your options on site and, for example, support with presentations and information events on the topic of "Efficient and economic district heating supply".



Personal technical support

We will advise you personally over the phone and on site. Arrange an appointment with one of our technical specialists.



Sales literature/internet presence

You can obtain detailed information about our product ranges, products and solutions conveniently via the internet (at www.rehau.uk/districtheating) and also as a hard copy. We also support the specialist trade with professional sales promotion tools tailored to the target group. Just get in touch with us.



Texts for invitations to tender

In order for you to receive the product you requested, we support you with detailed texts for invitations to tender, in Word format.



Technical literature

We offer you forms for the heat network layout and hydraulic sizing as well as test certificate templates and assembly, installation and laying instructions to download at: www.rehau.uk



Construction site support and training

Do you have any questions about installing our products for the first time? We will be happy to visit you on site and brief you and your colleagues.



REHAU Academy

The REHAU Academy seminars get to the heart of the most important topics and deliver practical knowledge from the areas of technology, law and sales. Our seminars are held regularly at our training centres, in the REHAU Sales Offices.

Successful design with REHAU

The impressive opportunities offered by polymer-based solutions open up a fascinating potential for our customers and end consumers. Architects, planners and users as well as investors and retailers benefit from our system solutions that are optimally tailored to their needs.

REHAU is a competent partner for environmental and economic future topics such as the use and transport of heat from solar thermal installations, modern CHP plants or industrial waste heat and waste heat from biogas installations. As a premium supplier, we don't just offer pure product solutions and systems but also comprehensive service and support.

Already in the design phase, REHAU is available to you as a reliable partner from the technical planning through to issuing quotations. The focus is on energy efficiency and cost-effectiveness of your construction project as well as on the technical implementation.

Our design centres in the Building Technologies engineering divisions will support you with the preliminary and draft design relating to the project as well as with the detailed design.

Simply complete the appropriate project questionnaire and send it online to your local REHAU Sales Office.



PLANUNGSaufTRAG REHAU
 OBJEKTFRAGEBOGEN FÜR
 RAUTHERMEX/RAUWITHERM WÄRMENETZE



INTERN Projektcode: _____ Bearbeiter: _____

Bauvorhaben

Name			
Straße/Hausnummer			
PLZ/Ort			
Planungsphase	<input type="checkbox"/> Vorplanung/Kostenschätzung	<input type="checkbox"/> Entwurfsplanung	<input type="checkbox"/> Ausführungsplanung

Kundendaten

Name			
Straße/Hausnummer			
PLZ/Ort			
Tel./Fax/E-Mail			
Ansprechpartner			
<input type="checkbox"/> Installateur	<input type="checkbox"/> Planer	<input type="checkbox"/> Baugewerke	<input type="checkbox"/> Behörden <input type="checkbox"/> Andere

Dimensionierung

Gewünschte Fertigstellung bis: _____

Dimensionierung Nah- Fernwärmenetz
 1. Allgemeine Daten

Heizung:	Vorlauftemperatur _____ [°C]	Rücklauftemperatur _____ [°C]
Druckverluste:	Druckverluste Heizzentrale _____ [Pa]	Druckverluste Übergabestation _____ [Pa]
Lage Wärmenetz:	Höhenlage Tiefpunkt des Netzes: _____ [m über NN]	Höhenlage Höchstpunkt des Netzes: _____ [m über NN]
Lage-Höhenplan soweit vorhanden beiliegen!		

	BHKW 1	BHKW 2	BHKW 3
Thermische Leistung(en) der Heizzentrale(n)/BHKW:	_____ [kW]	_____ [kW]	_____ [kW]

The right partner in an instant

In order to complete your projects to a high standard and on time, you need a reliable, professional partner. We will support you with developing a network, provide you with details of specialist firms that can optimally implement your requirements and will help you to look for bodies to issue energy performance certificates.

For simple requirements, the fast online search for specialist firms on our website offers a large selection. If particular qualifications are required, we will be happy to discuss a recommendation over the telephone and make contact for you.

REHAU partners in your area

We will provide you with:

- REHAU specialist installers
- Specialist civil engineering firms in your area
- Engineering offices



REHAU Sales Offices

REHAU wants to be close to its customers. Regional REHAU Sales Offices are at your service to provide fast, satisfactory and continuous on-site support. Our professional staff is on hand to offer expert advice and handle any inquiries and problems.

The most popular REHAU products are held in stock for you at efficient logistics centres and large warehouses. We support you with advice and action in the preparation and elaboration of large-scale projects or difficult designs up to realisation.

Make use of the REHAU milk run, which delivers the products to your company or construction site, or the REHAU distribution centres, which keep costs and planning time low.

Below, you will find the individual sales offices with their addresses and phone numbers:

1 Head Office

REHAU Ltd.
Hill Court,
Walford,
Ross-on-Wye,
Herefordshire,
HR9 5QN.

+44 (0)1989 762600
+44 (0)1989 762601
enquiries@rehau.com

2 Showroom

The REHAU Hub,
The Building Centre,
26 Store Street,
Fitzrovia,
London,
WC1E 7BT.

+44 (0)1989 762600
+44 (0)207 307 8595
enquiries@rehau.com

3 Dublin Sales Office

REHAU Ltd.
9 St. John's Court,
Business Park,
Swords Road, Santry,
Dublin 9,
Republic of Ireland.

+353 (0)1 816 5020
+353 (0)1 816 5021
enquiries@rehau.com

4 Glasgow Sales Office

REHAU Ltd.
Phoenix House,
Phoenix Crescent,
Strathclyde Business Park,
Bellshill,
ML4 3NJ.

+44 (0)1698 503700
+44 (0)1698 503701
enquiries@rehau.com

5 Manchester Sales Office & Distribution Centre

REHAU Ltd.
Northbank Ind Est,
Brinell Drive,
Irlam,
Manchester,
M44 5BL.

+44 (0)161 777 7400
+44 (0)161 777 7401
enquiries@rehau.com

6 Factory

REHAU Ltd.
Tanygrisiau,
Blaenau Ffestiniog,
Gwynedd,
LL41 3RY.

+44 (0)1766 833700
+44 (0)1766 833701



This document is protected by copyright. All rights based on this are reserved. No part of this publication may be translated, reproduced or transmitted in any form or by any similar means, electronic or mechanical, photocopying, recording or otherwise, or stored in a data retrieval system.

Our verbal and written advice with regard to usage is based on years of experience and standardised assumptions and is provided to the best of our knowledge. The intended use of REHAU products is described comprehensively in the technical product information. The latest version can be viewed at www.rehau.com/TI. We have no control over the application,

use or processing of the products. Responsibility for these activities therefore remains entirely with the respective user/processor. Where claims for liability nonetheless arise, they shall be governed exclusively according to our terms and conditions, available at www.rehau.com/conditions, insofar as nothing else has been agreed upon with REHAU in writing. This shall also apply for all warranty claims, with the warranty applying to the consistent quality of our products in accordance with our specifications. Subject to technical changes.

www.rehau.com/locations

© REHAU Industries SE & Co. KG
Rheniumhaus
95111 Rehau

817602 EN 02.2022