



Gasmate®

THE OUTDOORS MADE EASY.

BBQs 2021-22



Customer Service (Australia Only)

1300 174 876

Monday to Friday 8am - 5pm AEST



CONTENTS

NOVA GRAPHITE OUTDOOR KITCHEN	04	CATERER 4&6 BURNER BBQs	22
NOVA GRAPHITE BBQs	08	DELUXE PIZZA OVEN	24
NOVA GRAPHITE BUILT-IN BBQs	10	BBQ ACCESSORIES	26
NOVA GRAPHITE MODULES & BAR FRIDGE TOPS	12	BBQ & PIZZA OVEN COVERS	34
BAR FRIDGES	14	INSTALLATION & DIMENSIONS	36
ORION 4 BURNER FLUSH MOUNT DROP-IN BBQ	16		
DELUXE BBQ RANGEHOODS	18		
AVENIR 6 BURNER STAINLESS STEEL BBQ KITCHEN	20		



NOVA GRAPHITE

OUTDOOR KITCHEN



The **NOVA Graphite Outdoor Kitchen** gives you the ultimate flexibility when designing your own amazing outdoor cooking and entertaining area.

The **Gasmate NOVA Graphite Outdoor Kitchen** will take your alfresco area in a modern direction by incorporating dark stainless steel while still keeping all of the unique cooking features alfresco cooks have come to love from Gasmate.

The dark Graphite stainless blends well with stained wood decking and contrasts seamlessly with lighter colours.

It reduces the visual harshness and distinct contrast that, can at times, be the disadvantage of plain stainless steel.

One of the biggest drawbacks of traditional stainless steel is how smudges and fingerprints seem to multiply across its metallic surface, meaning extra work for you to keep it looking flawlessly clean. Graphite stainless steel, however, is much more resistant to smudges, fingerprints, streaks and water spots.

Graphite stainless steel complements many design concepts and colour schemes—largely because it “feels” a bit warmer than traditional stainless steel. Graphite stainless steel is ideal against white and grey, for a fresh, modern look. Yet the new finish also suits natural wood tones with its warmer undertones.

Graphite stainless steel is the same composition of iron, chromium, silicon, nickel and carbon that makes up traditional stainless steel products, but it has a protective coating of polymer that creates a black matte finish.















NOVA GRAPHITE BBQs

- Supplied fully assembled
- 6 Stainless Steel Burners – 12MJ/h each with individual controls
- High grade #304 stainless steel hood and exterior cabinet panels with Graphite stainless steel finish.
- Double skin hood for solid structure and better heat insulation, features temperature gauge and stylish slim cool touch handle
- 13MJ/h Ceramic rear burner for healthy rotisserie cooking with integrated high output 15MJ/h side burner. (not available on Twin Hood or Classic Built-In BBQs)
- Easy to clean, heavy duty enamel coated cast iron plate and grill, featuring an angled self-draining system which allows cooking fats and oils to run easily into the drainage channel at the front of the BBQ
- Stainless steel flame tamers for controlled heat distribution and to minimise cooking fats flaring up
- Electronic ignition for effortless lighting
- Convenient internal lights and LEDs above control knobs
- Elevated high grade #304 stainless steel cooking and warming rack
- NOVA BBQs on trolley feature a cabinet with ample storage with convenient slide-out cylinder storage and locking castors
- AGA certified to Australian Standards
- Approved for natural gas conversion
- Supplied with LPG hose and regulator



										
FULLY ASSEMBLED	6 STAINLESS STEEL BURNERS	GRAPHITE STAINLESS STEEL FINISH	#304 STAINLESS STEEL HOOD	HIGH HEAT RATING	HEAVY DUTY ENAMEL COATED CAST IRON PLATE	STAINLESS STEEL FLAME TAMERS	ELECTRONIC IGNITION	INTERNAL LIGHTS	STAINLESS STEEL COOKING & WARMING RACK	GAS CERTIFIED TO AUSTRALIAN STANDARDS

NOVA GRAPHITE 6 BURNER BBQ	
Model Number:	BQ2090
Main burner output:	6 x 12MJ/h
Side burner output:	15MJ/h
Rear burner output:	1 x 13MJ/h
Combined output:	100MJ/h
Cooking surface finish:	Enamel coated cast iron
Cooking surface:	Plate - 320 x 420mm Grill - 320 x 420mm x 2
Total cooking area: (W x D)	960 x 420mm
Overall dimension: (W x D x H)	1470 x 685 x 1200mm

NOVA GRAPHITE 6 BURNER TWIN HOOD BBQ	
Model Number:	BQ2092
Main burner output:	6 x 12MJ/h
Side burner output:	N/A
Rear burner output:	1 x 13MJ/h
Combined output:	85MJ/h
Cooking surface finish:	Enamel coated cast iron
Cooking surface: (Large Hood)	Plate - 327 x 422.6mm Grill - 327 x 422.6mm
Cooking surface: (Small Hood)	Plate - 227 x 422.6mm Grill - 227 x 422.6mm
Total cooking area: (W x D)	1108 x 422mm
Overall dimension: (W x D x H)	1375 x 685 x 1180mm



**NOVA GRAPHITE
6 BURNER BBQ**

BQ2090

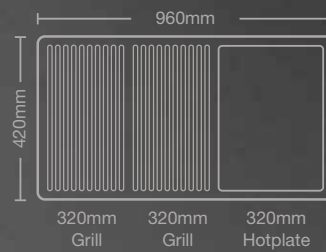

**NOVA GRAPHITE
6 BURNER TWIN
HOOD BBQ**

BQ2092

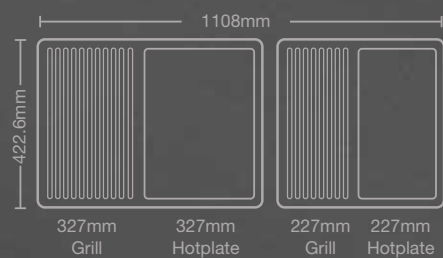

NOVA GRAPHITE BUILT-IN BBQs



For those that are wanting to build their own custom outdoor kitchen, with custom made cabinets, then the Gasmate NOVA Built-In BBQs are for you.

To take your outdoor kitchen design to the next level, featuring the NOVA Graphite stainless steel finish, the NOVA Graphite Built-In BBQs will help you create the ultimate, stylish and modern outdoor kitchen of your dreams.

Refer to page 36 for installation and dimensions

NOVA GRAPHITE 6 BURNER CLASSIC BUILT-IN BBQ

Model Number:	BQ2093B
Main burner output:	6 x 12MJ/h
Side burner output:	N/A
Rear burner output:	1 x 13MJ/h
Combined output:	85MJ/h
Cooking surface finish:	Enamel coated cast iron
Cooking surface:	Plate - 320 x 420mm Grill - 320 x 420mm x 2
Total cooking area: (W x D)	960 x 420mm
Overall dimension: (W x D x H)	1105 x 685 x 545mm



NOVA GRAPHITE 6 BURNER BUILT-IN BBQ

BQ2090B

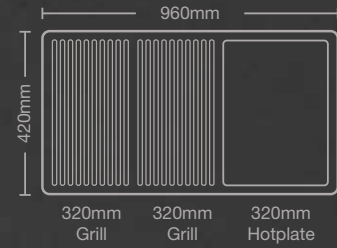

NOVA GRAPHITE 6 BURNER TWIN HOOD BUILT-IN BBQ

BQ2092B

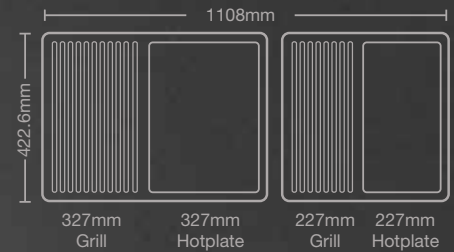

NOVA GRAPHITE 6 BURNER CLASSIC BUILT-IN BBQ

BQ2093B

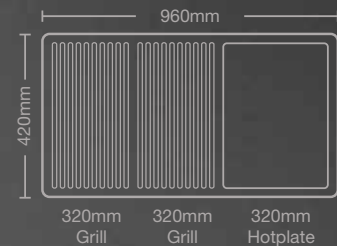

NOVA GRAPHITE 6 BURNER BUILT-IN BBQ

Model Number:	BQ2090B
Main burner output:	6 x 12MJ/h
Side burner output:	15MJ/h
Rear burner output:	1 x 13MJ/h
Combined output:	100MJ/h
Cooking surface finish:	Enamel coated cast iron
Cooking surface:	Plate - 320 x 420mm Grill - 320 x 420mm x 2
Total cooking area: (W x D)	960 x 420mm
Overall dimension: (W x D x H)	1470 x 685 x 545mm

NOVA GRAPHITE 6 BURNER TWIN HOOD BUILT-IN BBQ

Model Number:	BQ2092B
Main burner output:	6 x 12MJ/h
Side burner output:	N/A
Rear burner output:	1 x 13MJ/h
Combined output:	85MJ/h
Cooking surface finish:	Enamel coated cast iron
Cooking surface: (Large Hood)	Plate - 327 x 422.6mm Grill - 327 x 422.6mm
Cooking surface: (Small Hood)	Plate - 227 x 422.6mm Grill - 227 x 422.6mm
Total cooking area: (W x D)	1108 x 422mm
Overall dimension: (W x D x H)	1375 x 685 x 545mm

NOVA GRAPHITE MODULES

Play around with the following modules to create your very own design...

NOVA GRAPHITE SINK, BIN AND STORAGE MODULE

BQ2191



NOVA GRAPHITE STORAGE MODULE

BQ2192



- NOVA Graphite Sink, Bin and Storage Module features #304 grade Graphite stainless steel fascia, doors & kick plate, with premium porcelain top and black powder coated cabinet
- Durable stylish black sink
- WELS approved hot and cold tap
- Bin included under sink
- Stylish integrated handles
- Locking castors
- Full depth cabinets

- NOVA Graphite Storage Module features #304 grade Graphite stainless steel fascia, doors & kick plate with premium porcelain top and black powder coated cabinet
- 3 convenient shelves
- Stylish integrated handles
- Locking castors
- Full depth cabinets

NOVA GRAPHITE SINK, BIN AND STORAGE MODULE

Model Number:	BQ2191
Sink:	Nano black stainless steel
Tap:	WELS approved hot & cold tap in black colour
Bin:	Included under sink
Dimension: (W x D x H)	830 x 685 x 905mm

NOVA GRAPHITE STORAGE MODULE

Model Number:	BQ2192
Doors:	2
Shelves:	3 Convenient shelves
Dimension: (W x D x H)	830 x 685 x 905mm

Refer to page 36 for installation and dimensions.

NOVA GRAPHITE 3 DRAWER MODULE

BQ2193



- NOVA Graphite 3 Drawer Module features #304 grade Graphite stainless steel fascia, drawers & kick plate with premium porcelain top and black powder coated cabinet
- 3 large capacity drawers
- Stylish integrated handles
- Locking castors
- Full depth cabinets

NOVA GRAPHITE 3 DRAWER MODULE	
Model Number:	BQ2193
Drawers:	3 Large capacity
Dimension: (W x D x H)	830 x 685 x 905mm

NOVA GRAPHITE PREMIUM BAR FRIDGE TOPS

BQ2197 & BQ2198



- If you want to add a Gasmate Premium bar fridge to your NOVA Graphite Outdoor Kitchen, it's super easy, you just use the fridge top to integrate it perfectly
- Graphite stainless steel fascia with premium porcelain top to match the NOVA Graphite modules
- Supplied fully assembled
- Available to suit the Gasmate 1 Door Premium Fridge or 2 Door Premium Fridge

NOVA GRAPHITE PREMIUM 1 DOOR BAR FRIDGE TOP	
Model Number:	BQ2197

NOVA GRAPHITE PREMIUM 2 DOOR BAR FRIDGE TOP	
Model Number:	BQ2198

PREMIUM BAR FRIDGES

- A stylish and functional addition to your outdoor space
- Powered by an LG Compressor
- #430 grade brushed stainless steel exterior finish
- #304 grade mirror stainless steel interior finish
- Triple glazed glass door to retain cool temperature in the fridge and cuts down UV
- Designed for outdoor undercover use - IPx4 rated
- Front vents allow installation in outdoor cabinetry with minimal clearances
- Adjustable digital thermostat for temperature control in door
- Self closing door with lock and magnetic door seal
- Heated door to reduce condensation
- Internal LED lights
- Adjustable shelves
- Height adjustable feet
- Limited 5 year warranty
- The 1 and 2 Door Premium Bar Fridge, can be used on its own or as part of the Gasmate Nova Graphite Outdoor Kitchen (with special tops sold separately).



RUST PROTECTION



FULLY ASSEMBLED



TESTED AND APPROVED TO AUSTRALIAN STANDARDS



TROPICAL RAGED TO 42+ DEGREES

2 DOOR PREMIUM 228L BAR FRIDGE

MODEL NO: **GMF229G**

Dimension: (W x D x H) 903 x 503 x 855mm

1 DOOR PREMIUM 118L BAR FRIDGE

MODEL NO: **GMF119G**

Dimension: (W x D x H) 503 x 503 x 855mm

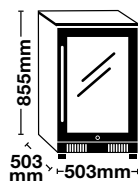
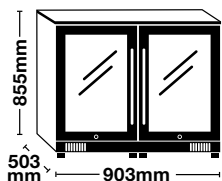

STANDARD BAR FRIDGES

- Compressor refrigerator
- #430 grade brushed stainless steel exterior finish
- #304 grade mirror stainless steel interior finish
- Low noise operation
- Adjustable thermostat
- Double glazed glass doors with lock
- Height adjustable feet
- Internal LED lights
- Adjustable shelves



RUST PROTECTION



FULLY ASSEMBLED



TESTED AND APPROVED TO AUSTRALIAN STANDARDS



TROPICAL RAGED TO 42+ DEGREES

2 DOOR STANDARD 228L BAR FRIDGE

MODEL NO: **GMF228H**
Dimension: (W x D x H) 903 x 503 x 855mm

1 DOOR STANDARD 118L BAR FRIDGE

MODEL NO: **GMF118H**
Dimension: (W x D x H) 503 x 503 x 855mm

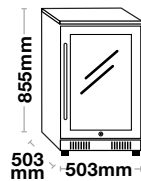
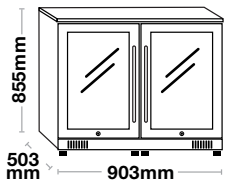

ORION 4 BURNER FLUSH MOUNT **DROP-IN BBQ**

The Gasmate Orion 4 Burner Flush Mount Drop-in BBQ allows you to enjoy all the features of a Gasmate BBQ but be incorporated into any custom designed outdoor kitchen. You can even create a BBQ island that you can cook with from both sides.



ORION 4 BURNER FLUSH MOUNT
DROP-IN BBQ



- #304 Grade stainless steel BBQ with hinged and removable lid
- Rotary piezo ignition for effortless lighting
- Easy to clean, heavy duty enamel coated cast iron plate and grill, featuring an angled self draining system which allows cooking fats and oils to run easily into the drainage channel at the front of the BBQ
- Cast iron burners with individual controls
- Stainless steel flame tamers for controlled heat distribution
- Gas certified to Australian Standards
- Available in natural gas
- Supplied with LPG hose and regulator (propane models only)

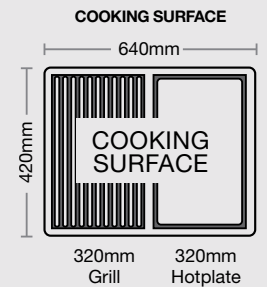

				
RUST PROTECTION	HIGH HEAT RATING	HIGH HEAT RATING	FULLY ASSEMBLED	PUSH BUTTON IGNITION

4 BURNER DROP IN BBQ

MODEL NO:	BQ10964B
Main burner output:	4 x 13.5MJ/h
Combined output:	54MJ/h
Cooking surface finish:	Satin enamel cast iron and stainless steel
Cooking surface:	Plate - 320 x 420mm Grill - 320 x 420mm
Total cooking area: (W x D)	640 x 420mm
Overall dimension (W x D x H)	933 x 609 x 245mm

4 BURNER DROP IN BBQ NATURAL GAS

MODEL NO:	BQ10964BNG
Main burner output:	4 x 13.5MJ/h
Combined output:	54MJ/h
Cooking surface finish:	Satin enamel cast iron and stainless steel
Cooking surface:	Plate - 320 x 420mm Grill - 320 x 420mm
Total cooking area: (W x D)	640 x 420mm
Overall dimension (W x D x H)	933 x 609 x 245mm

Refer to page 41 for installation and dimensions

DELUXE BBQ RANGEHOODS



CONVENIENT FRONT MOUNTED LED LIGHTING SO YOU CAN SEE WHAT YOU ARE COOKING WHETHER YOUR BBQ HOOD IS OPEN OR CLOSED.

- Marine grade #316 stainless steel body with black tempered glass fascia creates a bold, on-trend style
- #316 Stainless Steel Body
- #316 Stainless Steel Baffle Filters - Easy to remove and clean
- Black Tempered Glass Fascia
- 3 Speed, Soft-touch controls with 15-minute auto shut-off timer
- Remote Control Included
- Fully Sealed Copper Motors
- 2m Aluminium Ducting Included
- Front Mounted LED Lighting
- Minimum 1200mm from BBQ cooking surface to Rangehood

#316 STAINLESS STEEL BAFFLE FILTERS - EASY TO REMOVE AND CLEAN.

SOFT-TOUCH CONTROLS, 3 SPEED LEVELS, 15-MINUTE AUTO SHUT-OFF TIMER AND LED LIGHTING.

STAINLESS STEEL

BLACK GLASS
FASCIA



#316
STAINLESS
STEEL BODY



#316 STAINLESS STEEL
BAFFLE FILTERS - EASY
TO REMOVE AND
CLEAN



BLACK
TEMPERED
GLASS FASCIA



3 SPEED, SOFT-TOUCH
CONTROLS WITH
15-MINUTE AUTO SHUT-
OFF TIMER



REMOTE
CONTROL
INCLUDED

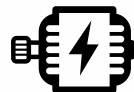

FULLY SEALED
COPPER
MOTORS



2M ALUMINIUM
DUCTING
INCLUDED



FRONT
MOUNTED
LED LIGHTING

150cm LARGE WALL MOUNTED RANGEHOOD

MODEL NO:	GR1500
Extraction capacity:	3000M ³ /Hr
Flexible ducting:	3 x 150mm Ø
Lights:	6 x LED, 12V - 1.8W
Motor capacity:	3 x 1000W
Noise level:	<90 Dba
Weight:	68Kg
Dimension: (W x D x H)	1500 x 800mm

120cm MEDIUM WALL MOUNTED RANGEHOOD

MODEL NO:	GR1200
Extraction capacity:	2000M ³ /Hr
Flexible ducting:	2 x 150mm Ø
Lights:	4 x LED, 12V - 1.8W
Motor capacity:	2 x 1000W
Noise level:	<80 Dba
Weight:	50Kg
Dimension: (W x D x H)	1200 x 800mm

Refer to page 42 for installation and dimensions



AVENIR 6 BURNER STAINLESS STEEL BBQ KITCHEN



- Stainless steel hood with powder coated ends and glass viewing window
- Stainless steel burners, fascia and cabinet doors
- Powder coated cabinets
- Cast iron hotplate and grills with chrome warming rack
- Stainless steel tubular burners lit by electronic ignition
- Includes sink and storage module
- Ample storage space

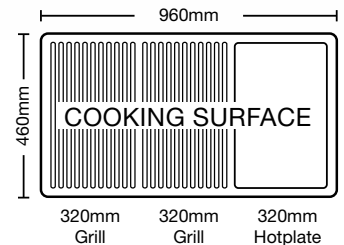

DURABLE
FINISH



RUST
PROTECTION



ELECTRONIC
IGNITION



TEMPERATURE
GAUGE



HIGH HEAT
RATING



GAS CERTIFIED
TO AUSTRALIAN
STANDARDS

6 BURNER STAINLESS STEEL BBQ KITCHEN

MODEL NO:	BQ2026KIT
Main burner output:	6 x 13.5MJ/h
Combined output:	81MJ/h
Cooking surface finish:	Cast iron
Cooking surface:	Plate - 320 x 460mm Grill - 320 x 460mm x2
Total cooking area: (W x D)	960 x 460mm
Overall dimension: (W x D x H)	2259 x 550 x 1187mm



FOLD DOWN SIDE SHELVES FOR CONVENIENT STORAGE.



REMOVABLE LID THAT DOUBLES AS A WINDSHIELD.

LARGE COOKING AREA HAS BEEN DESIGNED TO DRAIN FAT EASILY.



“SURE-FIRE” ROTARY PIEZO IGNITION FOR EASY LIGHTING.

STURDY TROLLEY.

CONVENIENT WHEELS.

CATERER 4 & 6 BURNER BBQs

Both models with
fold down shelves for
convenient storage

The ideal BBQ for sports and
social clubs or large groups.



HIGH HEAT
RATING



GAS CERTIFIED
TO AUSTRALIAN
STANDARDS



EASY
ASSEMBLY



ROTARY PIEZO
IGNITION



- Ideal barbecue for sports and social clubs or large groups
- High temperature powder coated barbecue
- Sturdy trolley with Fold down side shelves for convenient storage
- Removable lid that doubles as a windshield
- Large cooking area has been designed to drain fat easily

- Durable and efficient stainless steel burners with individual controls
- Cooking surface 5mm thick steel hotplate
- “Sure-fire” Rotary piezo ignition for easy lighting
- Warming rack included
- Complete with cylinder storage hook and wire storage rack
- Convenient wheels
- Gas certified to Australian Standards

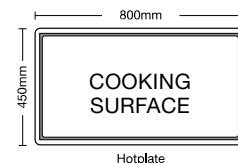
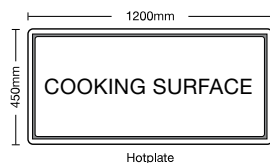

6 BURNER BBQ

MODEL NO:	BQ1051
Combined output:	84MJ/h (6 x 14MJ/h)
Burners:	6 x Stainless steel
Total cooking area: (W x D)	1200 x 450mm
Overall dimension: (W x D x H)	1817 x 579 x 956mm

4 BURNER BBQ

MODEL NO:	BQ1050
Combined output:	56MJ/h (4 x 14MJ/h)
Burners:	4 x Stainless steel
Total cooking area: (W x D)	800 x 450mm
Overall dimension: (W x D x H)	1428 x 579 x 956mm

PIZZA OVENS

The Gasmate Pizza Ovens allow you to cook anything from pizza, with a delicious wood fired flavour, to a beautifully cooked roast dinner.



TEMPERATURE GAUGE



HIGH HEAT RATING



GAS CERTIFIED TO AUSTRALIAN STANDARDS



EASY ASSEMBLY

- Convenient electronic ignition
- Includes wood chip smoker box for extra flavour
- Deluxe outdoor oven for versatile cooking
- Heats up and ready to go in under 10 minutes
- Cooks up to 3 pizzas at a time
- Large viewing window with temperature gauge
- Powerful 21MJ/h stainless steel burner
- With handy oven light
- Easy clean vitreous enamel interior
- Cool touch heat resistant handle
- Includes food safe ceramic pizza stone
- Complete with 2 x wire cooking racks
- Supplied with hose and regulator
- Gas certified for Australian Standards
- Approved for Natural Gas conversion

VITREOUS ENAMEL DELUXE PIZZA OVEN

MODEL NO:	PO106
Finish:	Deluxe Vitreous Enamel
Main burner output:	21MJ/h
Cooking surfaces:	
Wire racks x 2	425 x 490mm
Ceramic stone x 1	355 x 380mm
Overall dimension: (W x D x H)	580 x 625 x 810mm

STAINLESS STEEL DELUXE PIZZA OVEN

MODEL NO:	PO110
Finish:	Deluxe Stainless Steel
Main burner output:	21MJ/h
Cooking surfaces:	
Wire racks x 2	425 x 490mm
Ceramic stone x 1	355 x 380mm
Overall dimension: (W x D x H)	580 x 625 x 810mm



VITREOUS ENAMEL DELUXE PIZZA OVEN PO106



DELUXE PIZZA OVEN CABINET

MODEL NO:	PS110
Overall dimension: (WxDxH)	1485 x 445 x 855mm

- Perfect for the Gasmate Pizza Oven
- Black powder coated body with deluxe stainless steel top and shelves
- Convenient side shelves for extra bench space
- Side shelves drop down for easy storage
- Convenient slide-out drawer perfect for storing all your pizza oven accessories
- Features a gas cylinder location hole
- Locking castors

Pizza Oven Cabinet sold separately



STAINLESS STEEL
DELUXE PIZZA OVEN
PO110

PLATES, GRILLS & FLAME TAMERS



320mm Cast Iron Grill

BGC320



Superior
grilling
performance

Dimensions:
320 x 480mm (WxD)

400mm Cast Iron Plate

BGC400



Superior
grilling
performance

Dimensions:
400 x 480mm (WxD)

320mm Satin Enamel Grill

BGE320

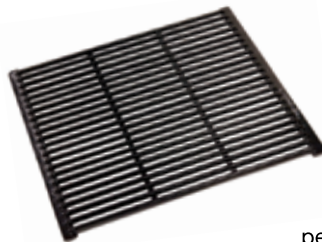

Superior
grilling
performance

Dimensions:
320 x 480mm (WxD)

400mm Satin Enamel Grill

BGE400



Superior
grilling
performance

Dimensions:
400 x 480mm (WxD)

320mm Cast Iron Plate

BPC320



Reversible
hotplate

Ribbed and
flat sides
for cooking
versatility

Easy to clean

Fits most standard
BBQ's on the market

Dimensions: 320 x 480mm (WxD)

400mm Cast Iron Plate

BPC400



Reversible
hotplate

Ribbed and
flat sides
for cooking
versatility

Easy to clean

Fits most standard
BBQ's on the market

Dimensions: 400 x 480mm (WxD)

320mm Satin Enamel Plate

BPE320



Reversible
hotplate

Ribbed and flat
sides for cooking
versatility

Easy to clean

Fits most standard BBQ's

Dimensions: 320 x 480mm (WxD)

400mm Satin Enamel Plate

BPE400



Reversible
hotplate

Ribbed and
flat sides
for cooking
versatility

Easy to clean

Fits most standard BBQ's

Dimensions: 400 x 480mm (WxD)

315mm Galaxy Satin Enamel Plate

BPE315



Reversible hotplate
Enamel coating protects against rust
Dimensions: 315 x 425mm (WxD)

315mm Stainless Steel Plate

BPS315



Heavy duty hotplate
High grade stainless steel
Dimensions: 315 x 425mm (WxD)

400mm Stainless Steel Plate

BPS400

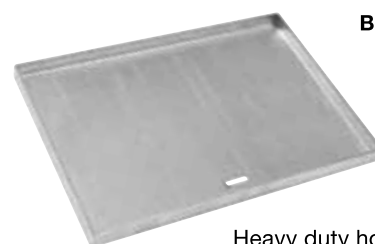

Heavy duty hotplate
High grade stainless steel
Dimensions: 400 x 480mm (WxD)

Flame Tamer 4B V/E Pressed Steel

GFTV4

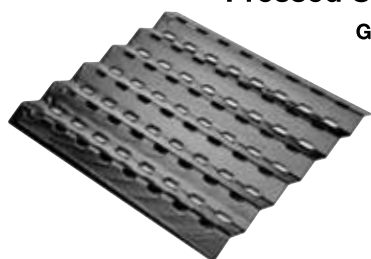

Dimensions:
385 x 405mm (WxD)

Flame Tamer 6B V/E Pressed Steel

GFTV6

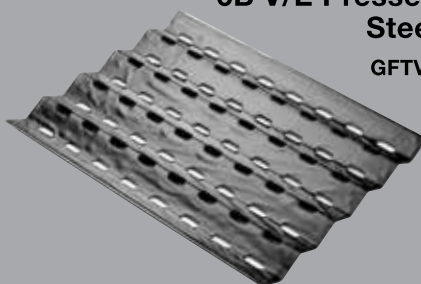

Dimensions:
320 x 405mm (WxD)

Adjustable Flame Tamer x2

GMFT1A

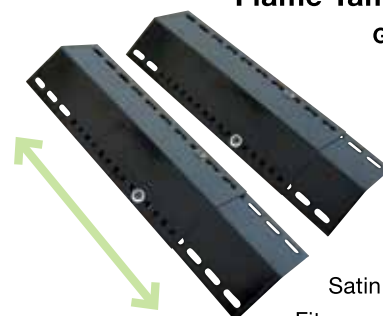

Satin enamel
Fits most BBQ's
Adjustable size

240mm Satin Enamel Roasting Dish with Lid

BDE240



Dimensions:
240 x 480mm (WxD)

320mm Satin Enamel Roasting Dish with Lid

BDE320



Dimensions:
320 x 480mm (WxD)

240mm Cast Iron Roasting Dish with Lid

BDC240



Dimensions:
240 x 480mm (WxD)

Adjustable Ceramic Briquette Flame Tamer

GMFT4-6B

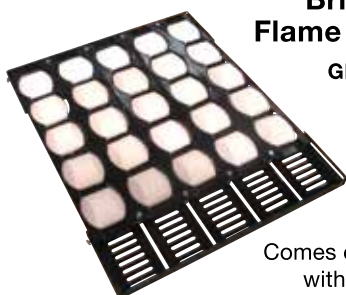

Comes complete
with a full set
of briquettes
Adjustable size

Ceramic Briquette 25pk

GMCR25

Suits ceramic briquette flame tamers
Gives food an enhanced BBQ flavour
Reduces flare-ups
Pack of 25



ACCESSORIES

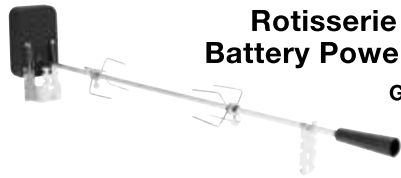

Rotisserie Kit Battery Powered

GRT2

Suits barbecues with roasting hoods up to 6 burners
 Supplied with all mounting hardware
 Uses 2 x D size batteries or transformer (not included)
 2 x 4 prong forks
 4 piece shaft
 4kg load capacity



Rotisserie Kit 240V

GRT3

Suits barbecues with roasting hoods up to 6 burners
 Supplied with all mounting hardware
 2 x 4 prong forks
 4 piece shaft
 8kg load capacity

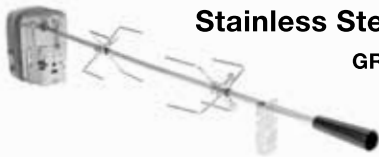

Rotisserie Kit 240V Stainless Steel

GRT4

Suits barbecues with roasting hoods up to 6 burners
 Supplied with all mounting hardware
 Stainless steel 240V motor
 4 x heavy duty 2 prong forks
 3 piece shaft
 15kg load capacity



Rotisserie Kit 240V Stainless Steel + Light

GRT5

Suits barbecues with roasting hoods up to 6 burners
 Convenient light with 20 watt light globe
 Supplied with all mounting hardware
 Stainless steel 240V motor
 4 x heavy duty 2 prong forks
 3 piece shaft
 15kg load capacity



240V Rotisserie Motor

BA1003

Will suit all Gasmate rotisserie kits
 8kg load capacity

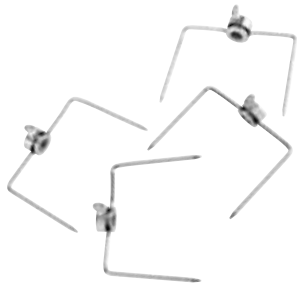

Rotisserie Prongs

BA1006

Chrome plated
 4 Pieces per set



Rotisserie Counter Weight

BA1007

Suits most rotisseries



4 & 6 Burner Rotisserie Shaft

GM4B6B

4 BURNER

6 BURNER

Unscrew and rotate handle to fit 4 and 6 burner BBQ rotisseries
 2 Piece shaft

Stainless Steel Gryos Disks 1 Pair

BA1039

Made from durable 304 stainless steel
 Up to 10mm
 (Note: Rod not included)
 Easy to use thumb screws



All Purpose BBQ Light

APL100

Attach to BBQ with either clamp or magnet
 6 High intensity LED bulbs
 Water resistant
 Includes 3 x AAA batteries



ET LED BBQ Light

BA1023

10 LED high intensity BBQ light
 Simply attach to BBQ handle
 Includes 3 x AA batteries included
 One touch operation

Pizza Cutter

BA1012

Stainless steel
pizza cutter



Pizza Trays

BA1012

Pack of 2
Diameter
410mm



Pizza Spatula

BA1014

Folding handle
with locking
device
Stainless steel
lifting surface



Pizza Stone

BA1019

Ceramic food grade stone
Dimensions:
360 x 380 x 10mm (WxDxH)

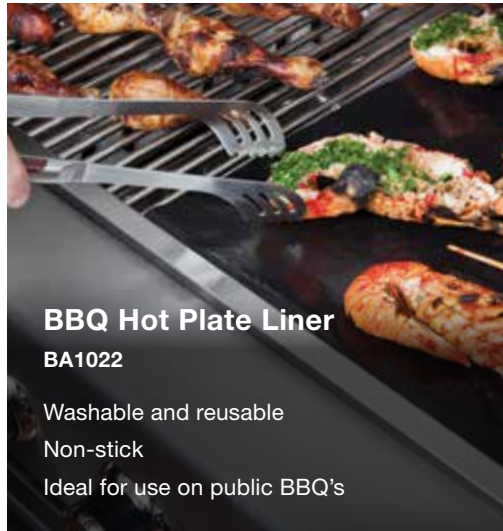

BBQ Hot Plate Liner

BA1022

Washable and reusable
Non-stick
Ideal for use on public BBQ's



Beer Can Chicken Roaster

GM058-030

Roast moist,
tender chicken
Use with favourite
beer or beverage in a
hooded BBQ or oven
Suitable for all
kinds of poultry
Fat drains away for
healthier cooking
Chrome plated finish
Dishwasher safe



Butane Fire Lighter

BT2000AL

Adjustable flame control
and piezo trigger ignition
Easily ignites softwood,
hardwood, charcoal, etc
Use in the kitchen to
caramelize sugar, char
or roast food
Heat shrinking,
soldering, pipe fitting
Includes 220g gas
cartridge

18.5cm Smoker Tube

BA2023

Made from quality
vitreous enamel
Dimensions:
18.5cm long



Stainless Steel Smoker Box

GM058-014

Durable stainless steel design
Dimensions:
22 x 9.5 x 4cm (WxDxH)

BBQ Meat Thermometer

GM058-013



Durable, reusable
stainless steel
thermometer
°F and °C scale

Remote Control Digital Thermometer

BA1008



Programmable
built in timer
5 Meat selections
5 Cooking settings
Built in LED flashlight
Beeps when food is ready

ACCESSORIES



BBQ Spatula
GM058-044

Stainless steel construction with rubber grip handles



BBQ Tongs
GM058-045

Stainless steel construction with rubber grip handles

Cooking Rings

GM058-102

Pack of 2
Dishwasher safe



3 in 1 BBQ Grill Brush

GM058-006

Abrasive pad scrubber

Durable stainless steel wire scrubbing brush

Handy steel scraper



Double Head BBQ Grill Brush

GM058-007

Durable brass wire scrubbing brush

Handy steel scraper removes burnt on food and fat residue

Dishwasher safe



Deluxe BBQ Grill Brush

GM058-066

Removes burnt food and fat residue

Durable stainless steel bristles

3 Sided to reach between grills



HOSES, REGULATORS & ADAPTORS

Procan1 Base & Adaptor

GM093B



Stabilising Procan1 base with 3/8" BSP -LH outlet. Procan1 is sold separately.

Bayonet Female Inlet Fitting

GMBH0078



Chrome plated
quick connect socket
Suits most mobile
LP gas appliances

Hose 1500mm 3/8" LH BSP - 1/4" BSP

GM1500



High quality
and robust
BBQ hose
Brass
fittings

Quick Connect Fitting

GMQC0012

→ Spring loaded



Quick connect coupler
AGA Certified
5/8" UNF thread

With the Gasmate Quick Connect Gas Fitting you will be able to quickly connect your gas hose to your gas appliance without worrying about the need for tools or leaks. Designed for use with all BBQ and Portable appliances up to 14kPa gas inlet pressure.

8mm Stainless Steel Braided Hose

1200mm
3/8" BSP Male & 1/4" BSP
Female Connections
GMBH0012

Adaptor converts
1/4" BSP outlet
to 3/8" BSP
outlet

AGA Certified



10mm Stainless Steel Braided Hose Bayonet

2000mm
GMBH0023
3000mm
GMBH0034

Adaptor converts
1/4" BSP female
to 3/8" BSP female

AGA Certified

For use with caravan
and RV sockets



8mm Stainless Steel Braided Hose with POL 2.75kPa Pressure Regulator

1200mm
GMBH0045
2000mm
GMBH0056
3000mm
GMBH0067
2.75kPa POL

Adaptor converts
1/4" BSP female to
3/8" BSP female

AGA Certified



BBQ Hose & Reg Kit 3/8" LH BSP With Adaptor

GMBBQHRA

Fits all Australian
propane/LPG BBQ's

Hand wheel cylinder
connection to suit POL
type cylinders

Length: 600mm

3/8" BSP connection or 1/4" BSP
connection with adaptor supplied

AGA Certified



Hose 900mm POL to 1-20" UNEF

GM110

High quality
and robust
BBQ hose

Brass
fittings



Hose 900mm 3/8" LH BSP - 1/4" BSP

GM900

High quality
and robust
BBQ hose

Brass
fittings



HOSES, REGULATORS & ADAPTORS



**Adaptor
GM093**

Adaptor to convert a 1"-20 UNEF outlet to a BSP-LH outlet



**Adaptor
GM016/013B**

Adaptor to convert a 3/8" BSP-LH outlet to a POL outlet

**Adaptor
GM002**



Adaptor to convert a POL outlet to twin 3/8" BSP-LH outlets to create two appliance connections (e.g. for a stove and lantern).

**Adaptor
GM003**

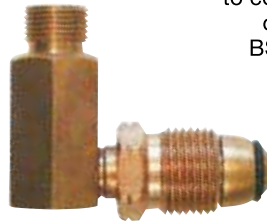

Right angled adaptor to convert a POL outlet to 3/8" BSP-LH outlet

**Adaptor
GM004**



Adaptor (straight) to convert a POL outlet to 3/8" BSP-LH outlet

**Natural Gas & Regulator with Full Flow Ball Valve
NGC40**



Thread adaptor - 1/4" BSP to 3/8" BSP
BBQ Jets not included (AGA regulations require manufacturers to supply jets)
Full flow shut off ball valve AGA Certified
Natural Gas regulator AGA Certified
10mm ID hose assemblies AGA Certified
Natural Gas label and instructions

**Natural Gas & Regulator with Quick Connect Bayonet Socket
NGC30**



Thread adaptor - 1/4" BSP to 3/8" BSP
BBQ Jets not included (AGA regulations require manufacturers to supply jets)
Quick connect safetyfitting AGA Certified
Natural Gas regulator AGA Certified
10mm ID hose assemblies AGA Certified
Natural Gas label and instructions

**Regulator
POL 3/8" LH BSP
GM8010-1**



Right angled regulator to suit POL cylinders with 3/8" BSP-F outlet to accommodate hoses, adaptors and other attachments
Also available in regulator to suit 3/8" BSP - LH with 3/8" BSP-F outlet

**Regulator
3/8" LH BSP - 3/8" LH BSP
GM8010R-3**



Right angled regulator to suit 3/8" BSP-LH cylinders with 3/8" BSP-F outlet to accommodate hoses, adaptors and other attachments
Also available in regulator to suit POL cylinders with 3/8" BSP-F outlet

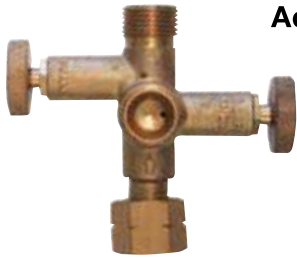

Adaptor
GM035

Connects to a camping (3/8" BSP) cylinder and creates two appliance connections (e.g. for a stove and lantern), individually controlled by valves



Adaptor

Solid Brass
Converts 1/4" BSP female to 3/8" BSP
GM021

Converts 1/4" BSP outlet to 3/8" SAE outlet
GM022



Adaptor
GM023

Solid Brass
Converts 3/8" SAE outlet to 1/4" BSP female outlet

MAINTENANCE



O-Ring POL
Cylinder Inlet
GMPOL-1

O-Rings



BBQ Knobs
Deluxe
GMKN-5

Suits most brand of BBQ's
Inserts to allow different sized spindles 6mm and 8mm options



BBQ Knobs
GMKN-4

Suits most brand of BBQ's
Inserts to allow different sized spindles 6mm and 8mm options



Rail Burner
Stainless Steel
2Pk
BA1020

Suits most brand of BBQ's
Tube burner style
2 in a pack
Stainless Steel
Length: 405mm



Rail Burner
Enamel
2Pk
BA1021

Suits most brand of BBQ's
High quality cast iron with satin enamel coating
2 in a pack
Length: 405mm



Rail Burner
Cast Iron
GRB8

Suits most brand of BBQ's
Durable cast iron construction for longevity
Cast burner ports for stable flame pattern
1 per pack
Length: 405mm



4 Point Electronic
Ignition Kit BBQ
GMPIK-4

Able to fit most BBQ's
Includes electronic igniter and earthing wire for unused ports
Requires 1 x AA battery (not included)



2 Point Electronic
Ignition Kit BBQ
GMPIK-2

Able to fit most BBQ's
Includes electronic igniter and earthing wire for unused ports
Requires 1 x AA battery (not included)



Electronic
Ignition Kit BBQ
GMPIK-1

Able to fit most BBQ's
Includes piezo button, cable, electrode and collector box

BBQ & PIZZA OVEN COVERS

Give your outdoor BBQ and Pizza Oven the best protection with a weather proof cover from Gasmate.



HEAVY DUTY MATERIAL



PROTECTS FROM THE ELEMENTS

PIZZA OVEN COVER

MODEL NO: **BC1D**

Keeps your pizza oven protected

Heavy duty fabric

Draw string for secure fit

Dimension: (W x D x H) 600 x 600 x 560mm



BUILT IN 4 BURNER BBQ HOODED COVER

MODEL NO: **GMBI4B**

4 Burner hooded cover for built in BBQ's

Quick and easy to fit

Velcro tabs for secure fit

Dimension: (W x D x H) 850 x 580 x 320mm



BUILT IN 6 BURNER BBQ HOODED COVER

MODEL NO: **GMBI6B**

6 Burner hooded cover for built in BBQ's

Quick and easy to fit

Velcro tabs for secure fit

Dimension: (W x D x H) 1110 x 580 x 320mm



COVERS

2 BURNER PREMIUM BBQ HOODED COVER

MODEL NO:	BAC823
2 Burner hooded cover	
Quick and easy to fit	
Velcro tabs for secure fit	
Dimension: (W x D x H)	1280 x 620 x 1170mm



4 BURNER PREMIUM BBQ FLAT TOP COVER

MODEL NO:	BAC842
4 Burner cover for flat top BBQ	
Quick and easy to fit	
Velcro tabs for secure fit	
Dimension: (W x D x H)	1650 x 640 x 900mm



4 BURNER PREMIUM BBQ HOODED COVER

MODEL NO:	BAC843
4 Burner premium hooded cover	
Velcro tabs for secure fit	
Dimension: (W x D x H)	1650 x 640 x 1170mm



6 BURNER PREMIUM BBQ HOODED COVER

MODEL NO:	BAC863
6 Burner premium hooded cover	
Velcro tabs for secure fit	
Dimension: (W x D x H)	2080 x 640 x 1170mm



NOVA GRAPHITE BUILT-IN BBQs

MODEL NO. BQ2090B / BQ2092B / BQ2093B

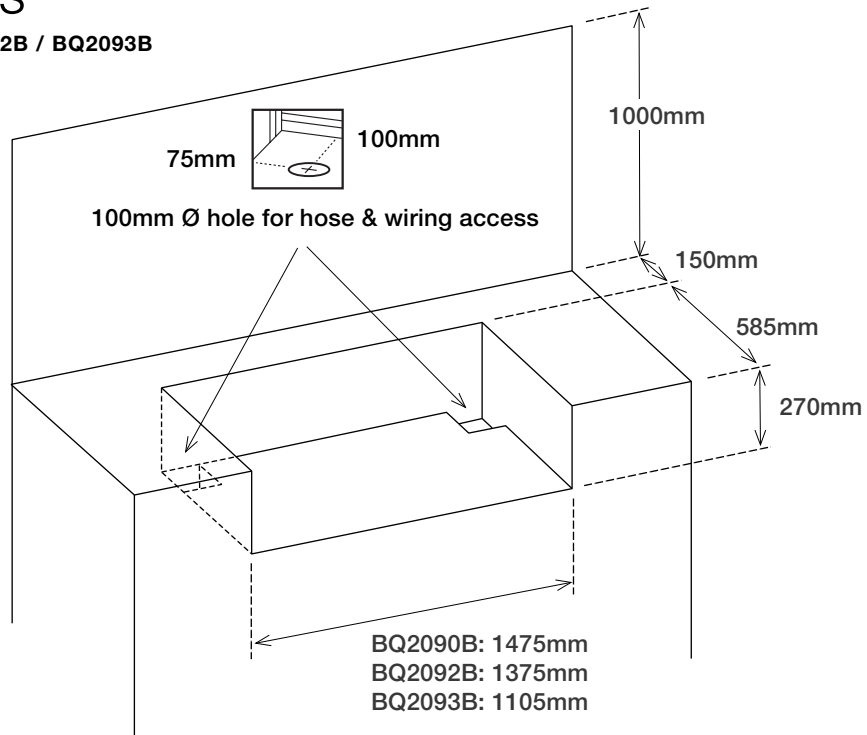

NOVA GRAPHITE SINK, BIN AND STORAGE MODULE

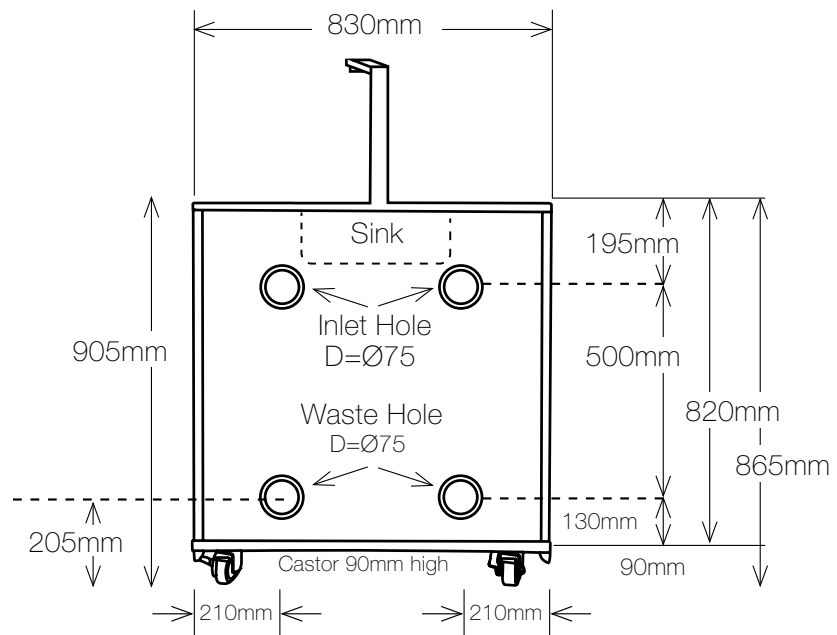

ORION BBQ DROP IN FLUSH MOUNT

4 Burner

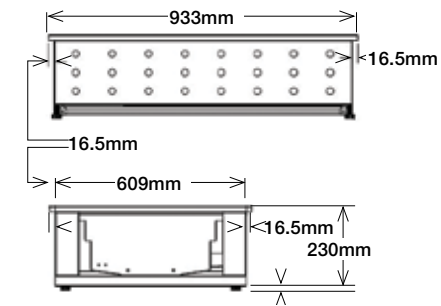

20mm +5mm FOOT ADJUSTMENT FOR BBQ LEVEL

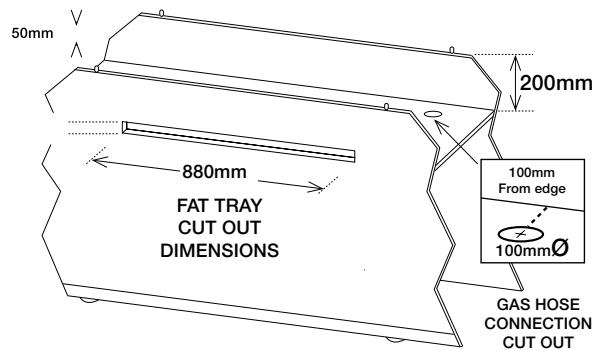
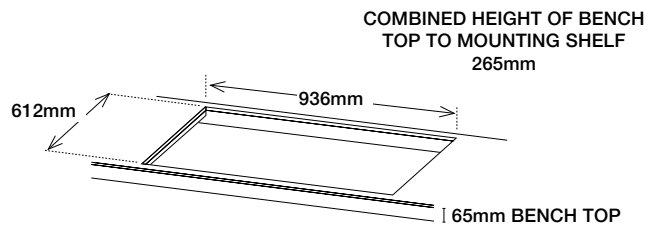
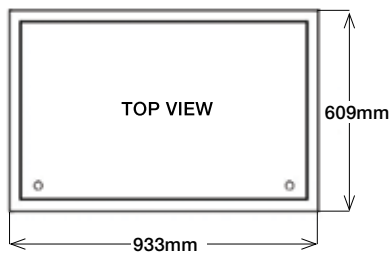

UNDER BENCH CLEARANCE 150mm ALL AROUND WALLS OF BBQ

RANGEHOOD CONTENT & DIMENSIONS

- 1 x Rangehood with 3 x 150mm duct adaptors fitted
- 2 x Chimney covers each 245mm high
- 1 x Chimney mounting bracket top
- 3 x Expanding ducts 150mm x 2m

- 1 x Rangehood with 2 x 150mm duct adaptors fitted
- 2 x Chimney covers each 245mm high
- 1 x Chimney mounting bracket top
- 2 x Expanding ducts 150mm x 2m

150cm LARGE WALL MOUNTED RANGEHOOD

MODEL NO: **GR1500**

120cm MEDIUM WALL MOUNTED RANGEHOOD

MODEL NO: **GR1200**

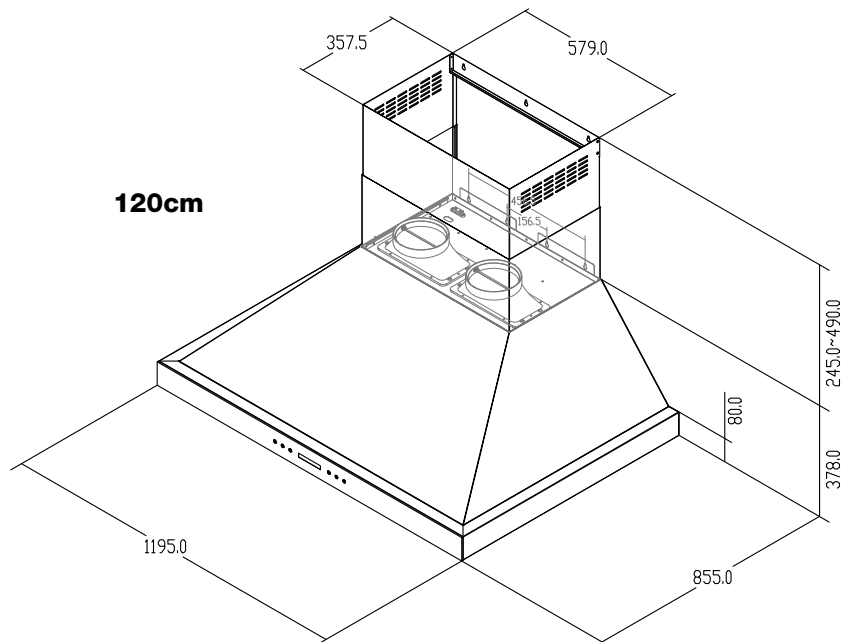
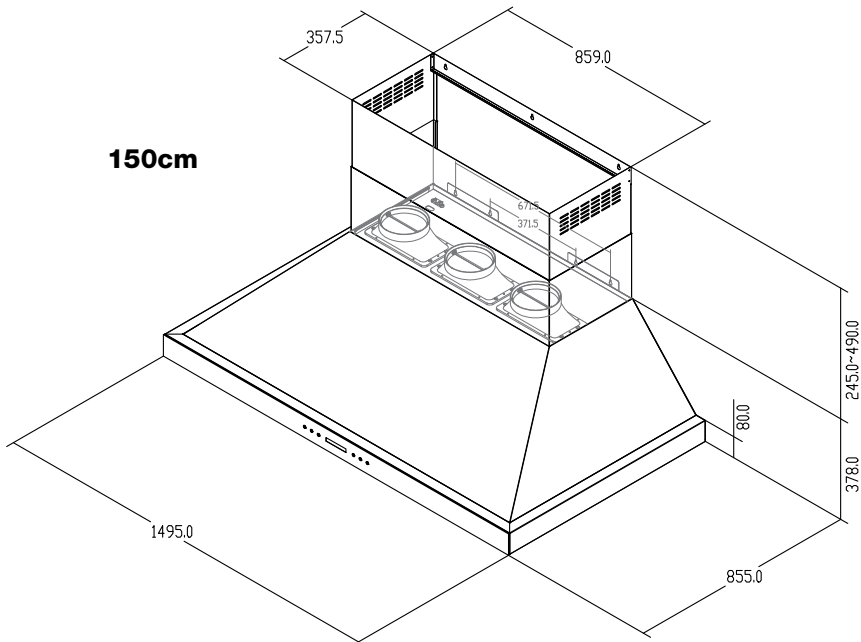

RANGEHOOD INSTALLATION

Please consider the following before commencing to install your rangehood. Your rangehood will need to be ducted to ensure it operates and complies with local and national regulations.

Duct Mounting Options

You will need some additional parts to complete these installations. All motors need to be ducted individually and the included expanding duct is 150mm diameter.

*If installing ducting at the rear or via the soffit/eave please review instruction for the reductions in ducting requirements.

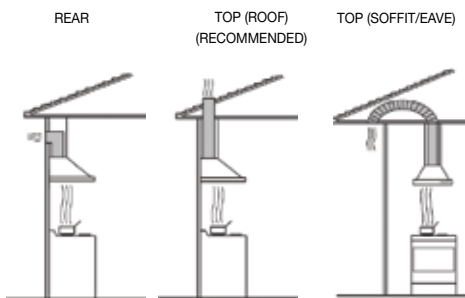

The Ideal Position of the Rangehood is as follows:

1. Height above cooking surface – 1200mm
2. Distance from cooking surface to rangehood mounting bracket bottom screw hole: refer to instruction manual for exact distance.

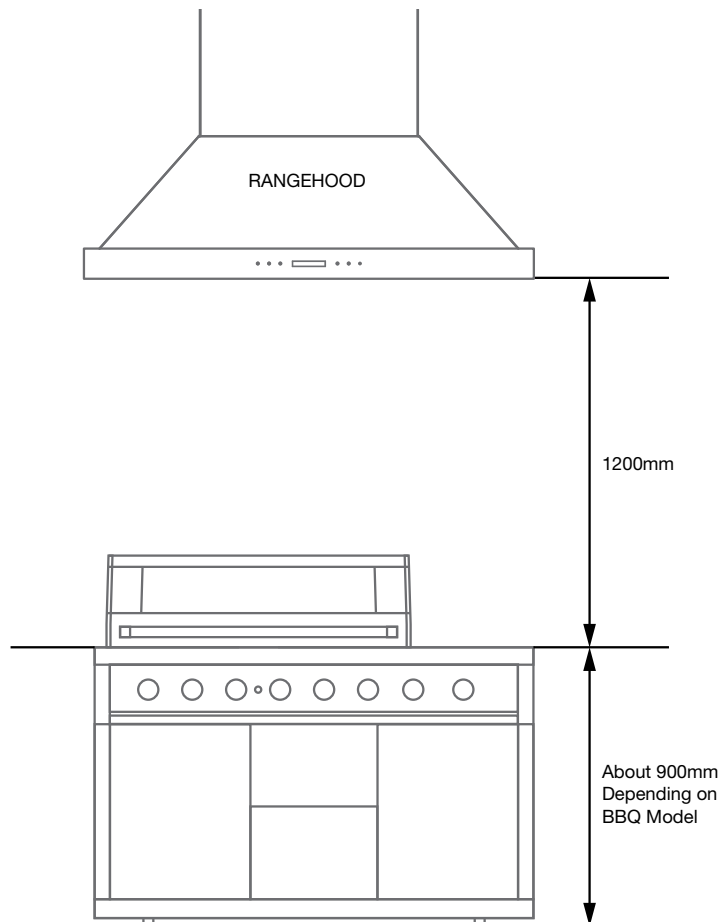

Gasmate

THE OUTDOORS MADE EASY.

BBQs 2021-22

Available From:

Customer Service (Australia Only)

1300 174 876

Monday to Friday 8am - 5pm AEST



www.gasmate.com.au



Follow us on:

Facebook @GasmateAustralia

Instagram @gasmate_au

All images are for reference only. Due to product development, product and images may differ.
Gasmate® is a registered trademark of Sitro Group Australia Pty. Ltd.
www.gasmate.com.au

04176 09/21