

AEROLUX

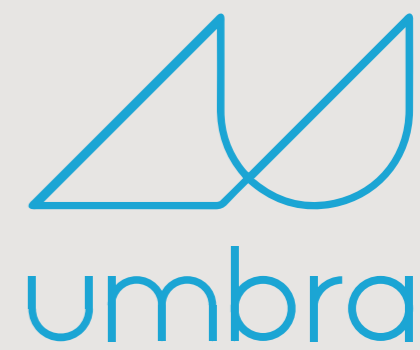

OUTDOOR
LIVING

AEROLUX

Innovative, modern and functional outdoor patio solution...

Aerolux is an innovated bioclimatic pergola system with full-automatic tilting / retractable aluminum louvres and provides excellent protection from the sun, rain all the while providing beneficial ventilation.

Aerolux bioclimatic pergola system is a modern choice that adds value to outdoor living areas, it brightens the look of home, restaurant, hotel or cafes with a touch of luxury. The system is designed to be adapted any kind of outdoor living areas and provides exceptional quality of life in the open air with a high degree of visual and thermal comfort.

The louvres in dimensions 180x40 mm are made from a special aluminum alloy which ensures exceptional strength. They form a flat and smooth ceiling and drain the rainwater to the discrete gutter in fully closed position.

The construction of the system with 160x160 mm post allows a high degree of resistance to strong winds and wide span between support columns. Possibility of installation as self standing makes this pergola a sustainable solution for terraces, patios, balconies, pool houses, hot tubs and outdoor kitchens. Several modules can be linked to each other and even larger patio roof can be created by coupling multiple modules lengthwise.



■ Led Stripe Dimmer Lighting

■ RGB Led-Hidden Stripe Lighting



Led Stripe Dimmer Lighting illuminates all around the system and creates a warm atmosphere. Dimmable Soft Led Stripe lighting on sides within the structure provides intensity of day light or cool white options.

RGB Led-Hidden Stripe Lighting provides ultimate luxury by creating distinctive atmosphere in outdoor living areas with infinite colour options.

Retractable & Tilting Version

Fully Closed



Retracted



Retracted & Tilted



Tilting Version

Fully Closed



Tilted

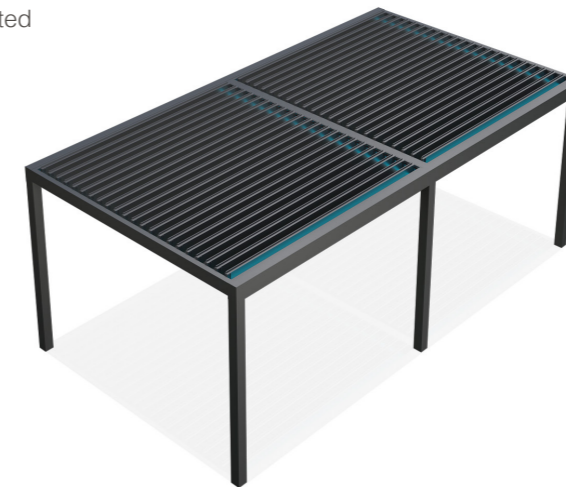

Louvre Closing Direction

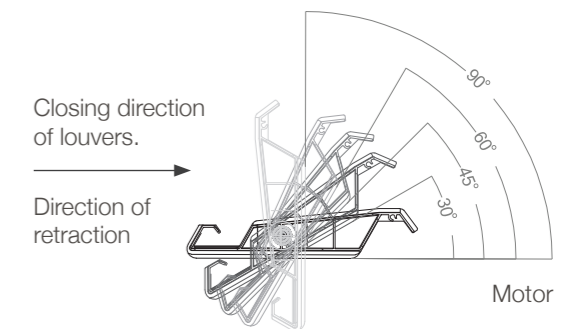

Tilting Directions

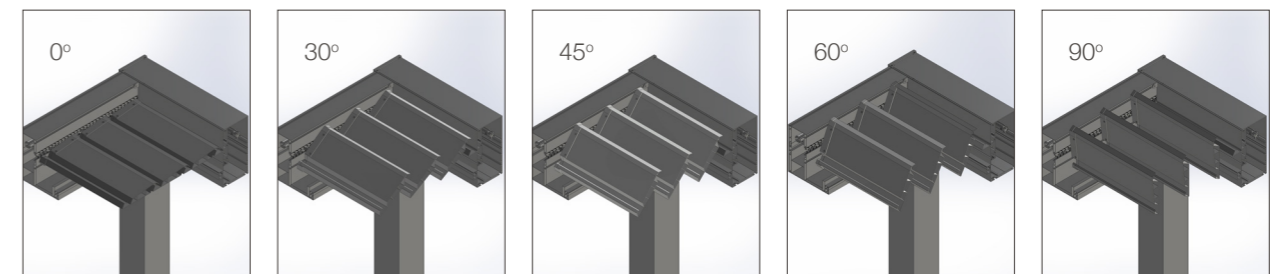

AEROLUX

Flexible installation methods are available with wall mounting and free standing installations and they can even be served as a roof assembled to existing frameworks.



Self Standing
Single Module

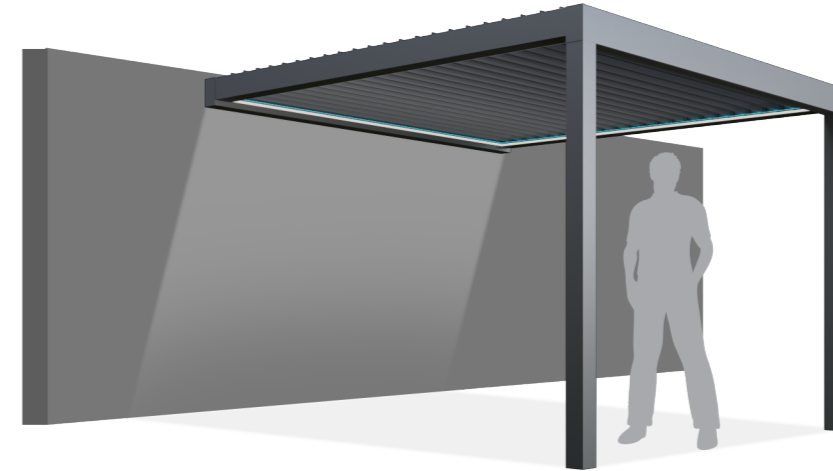

Wall Mounting
Single Module



Self Standing
Multiple Modules

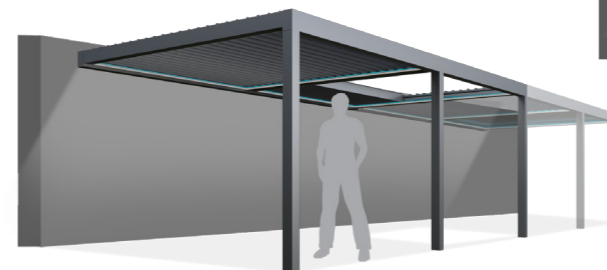

Wall Mounting
Multiple Modules

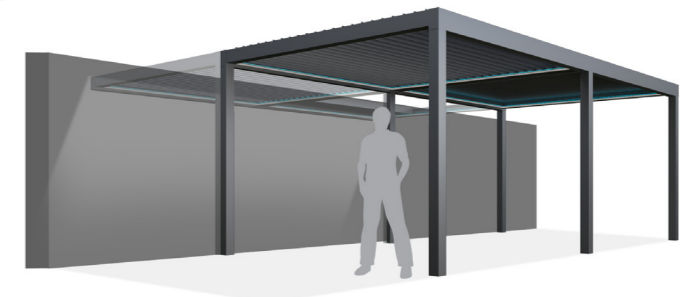
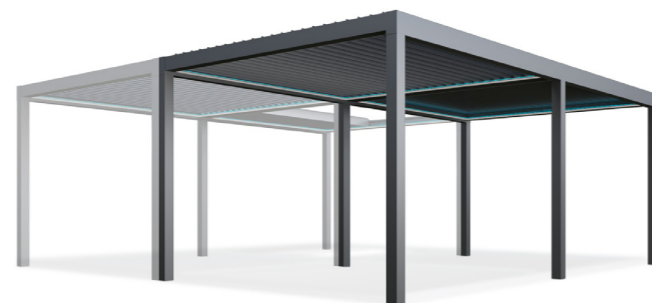

Blocked assembly for customized modules with a wide range of flexible combinations.

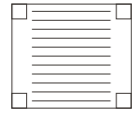

(w) Width
1800 mm < 4000 mm

(p) Projection
1569 mm < 6054 mm

(h) Height
3000 mm

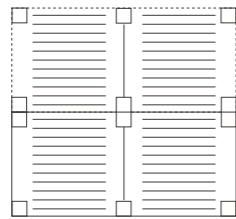
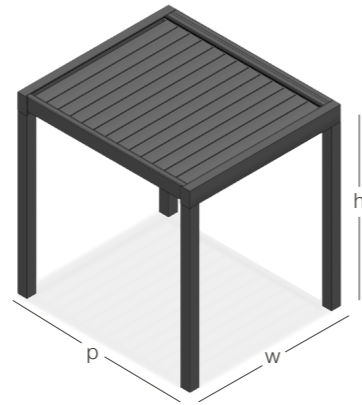

(w) Width
3600 mm < 8000 mm

(p) Projection
3138 mm < 12108 mm

(h) Height
3000 mm

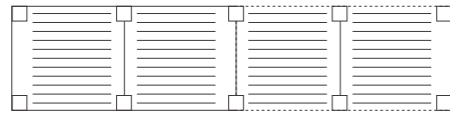
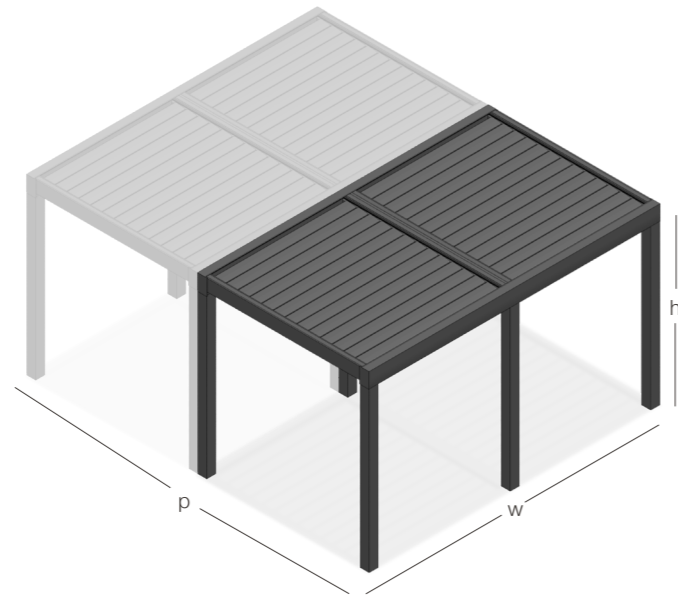

(w) Width
7200 mm < 16000 mm

(p) Projection
1569 mm < 6054 mm

(h) Height
3000 mm

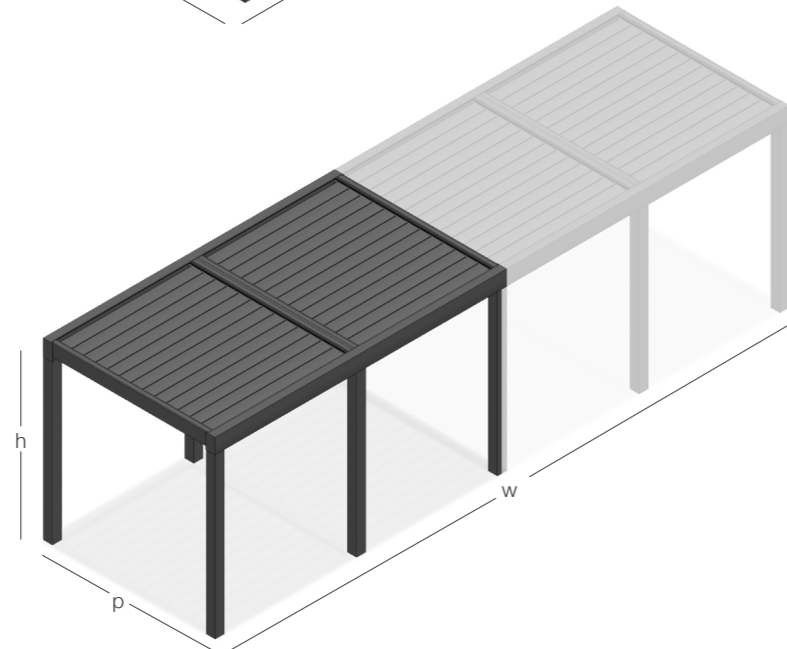

Intra-Column Drainage Pipe

The water can be drained through internal drainage pipe and it eliminates factors that could block correct water flow. Intra-column drainage pipe collects the water and discharges to the ground.

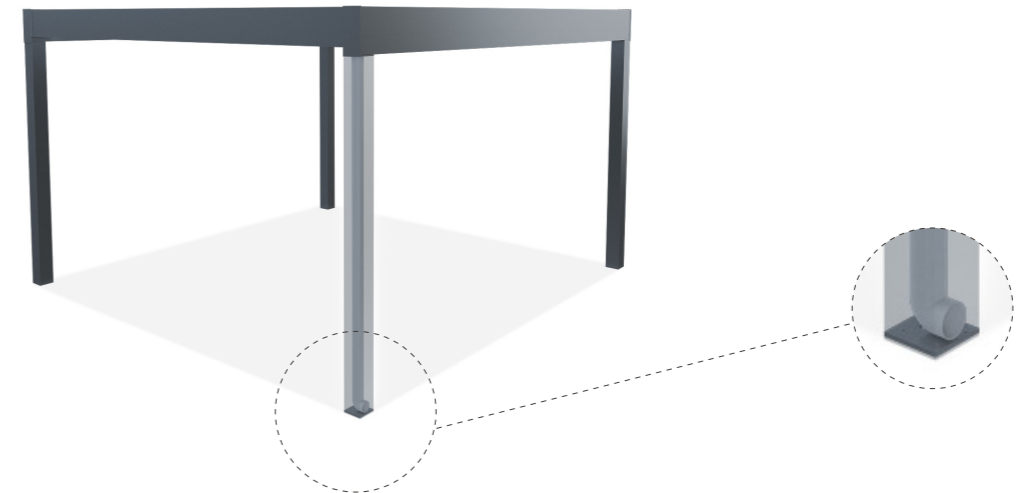
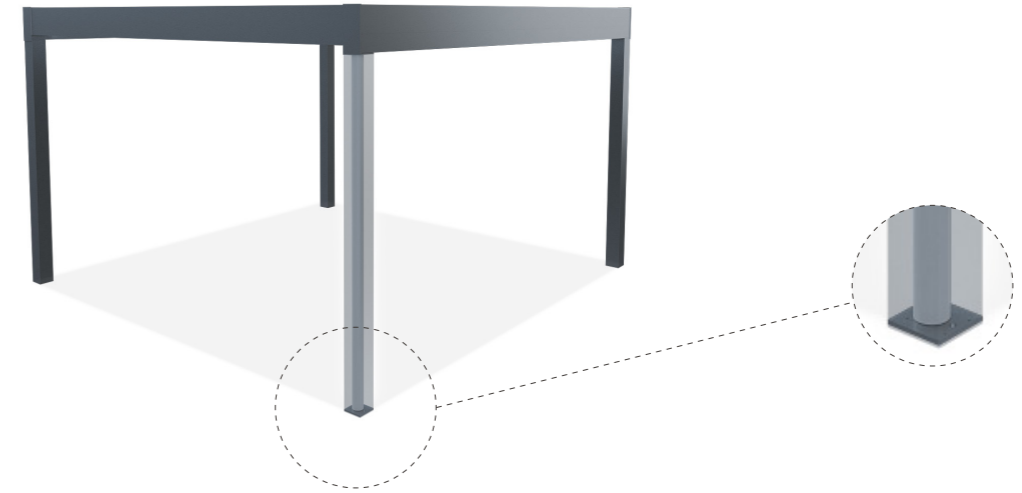



Slightly opening of louvres creates natural air flow for application areas.

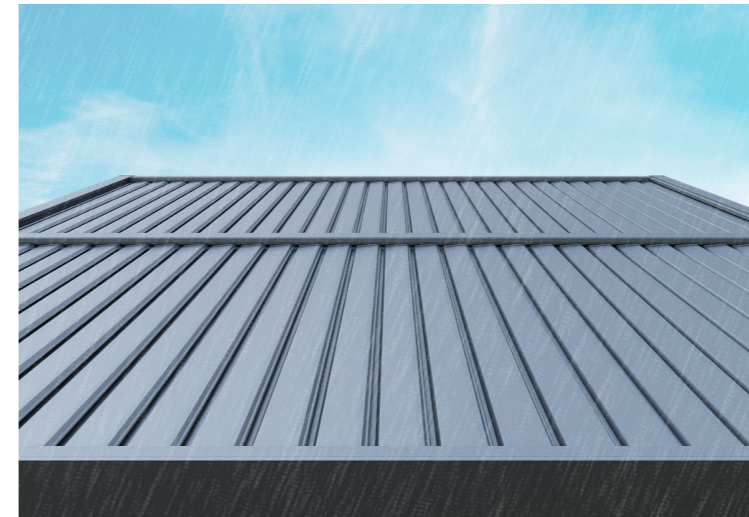

Ensuring waterproof coverage when louvres are in fully closed position.

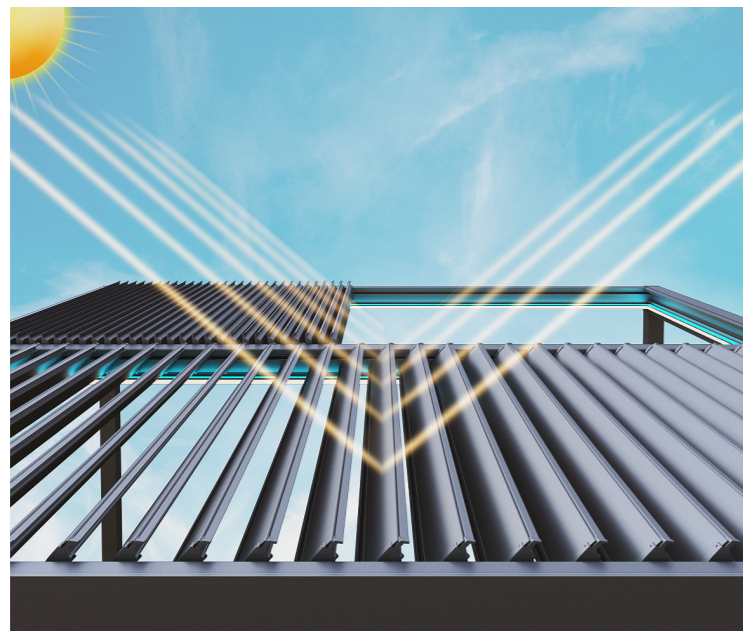

Protecting from sun exposure while ensuring air ventilation under the system .

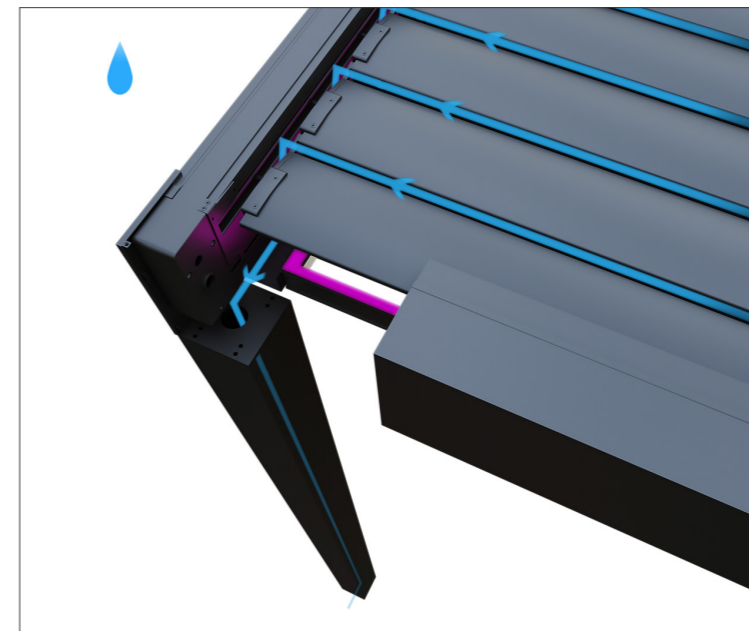

Each channel on louvres drain the water through four sided gutters connected with columns.

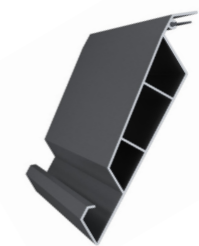

Functional seal entegrated on louvre channels provides maximum protection from water dripping.

Closures

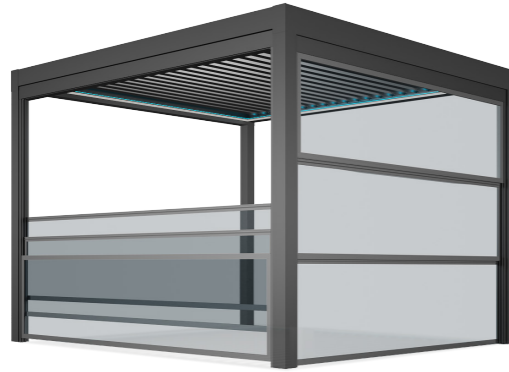

Sapphire/Cycle Guillotine Glass System
System can be adapted to Aerolux system and offers a maximum clear span that provides unobstructed view & minimalistic style. The system is operated by just the touch of button.



Framee Sliding Glass System
Minimal line of Framee system is perfectly matching with modern architectural Aerolux system by insulated fine-framed sliding glass panels. System offers a comfortable sliding with easy individual movement.

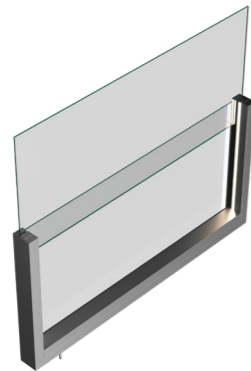

Swind-Motorised Windbreaker System
Swind can be combined with also Aerolux system and offers adequate wind breaking with the option of total transparency by incorporating the function of balustrade. Thanks to led stripe dimmer lighting integrated side frame the fixed panel assigns distinctive appeal. The system is modular and completely flexible as there are no limits in the horizontal direction that can be used to surround spaces of all types and sizes.

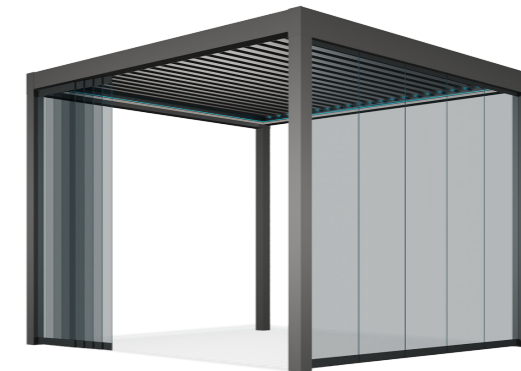

Slidia Sliding Glass System
The combination of the sliding glass system with Aerolux ensures efficacious protection from wind and rain. The aluminium frames which cover each glass panel provide maximum safety standards and practicality with elegance details.



Violet Glass Balustrade System
The adaptability of Violet fixed balustrade glass with Aerolux creates a stunning visual transparency without lacking of obstruction to lines of sight. The stylish lighting solution that is integrated underneath the glass highlights attractive aspect of the design by amplifying overall aesthetic of outdoors. Thanks to flexible and multiple modular implementations, system can be used to cover comprehensive areas without limitation in the horizontal direction.



Vertex Zip Screen System
The minimalist, slimlane, contemporary design of the zip system provides comfortable shade and protects against the UV rays. The system includes motorised aluminium structure, entirely powder-coated with stainless steel bolts and screws.



Wallfix Fixed Side Enclosure
The unique designed privacy of Wallfix side enclosure can be combined with Aerolux system to optimise outdoor living areas visually.

Overview

Operations

Retractable & Tilting



Tilting

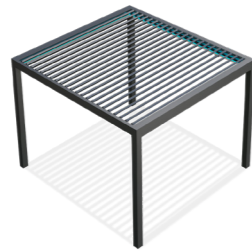

Lighting Options

Led Stripe Dimmer Lighting

Cool White

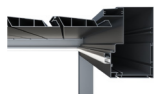

Day Light

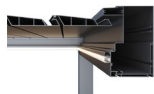

RGB Led-Hidden Stripe Lighting

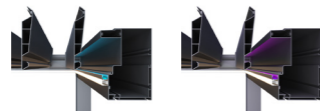
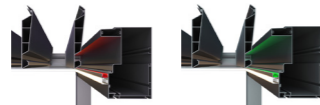

Optional Insulation Foam

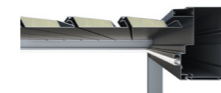

Sensors

Rain Sensor

Wind Sensor

Installation Types

Self Standing Single Module



Self Standing Multiple Modules

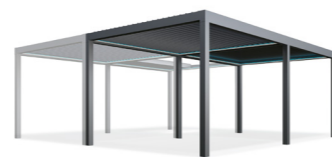

Wall Mounting Single Module

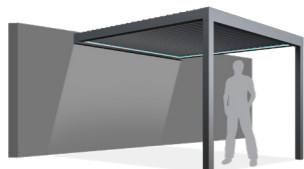

Wall Mounting Multiple Modules

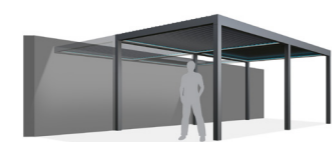
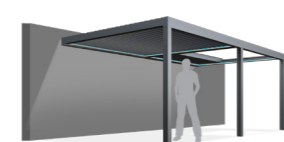

Closures

Sapphire & Cycle



Swind

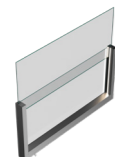

Violet



Framee



Slidia

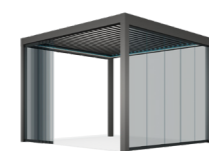

Vertex



Wallfix



Technical Details



Max. width for single module	4000 mm
Max. projection single module	6054 mm
Rafter profile dimension	228x260 mm
Post dimension	160x160 mm
Louvre dimension	180 mm
Louvre quantity in max. size	29 pcs
Louvre can be tilted up to	90°
Louvres parking area	23%
Automation	included
Control unit	included
Led Stripe Dimmer lighting	optional
RGB Led - Hidden Stripe lighting	optional
Insulation foam	optional
Edge cover profile	N/A
Drainage pipe	optional
Flange	optional
Rain Sensor	optional
Wind Sensor	optional

ALUMINIUM

basic

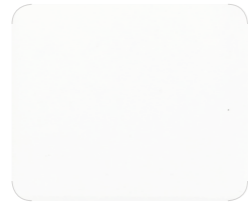

RAL 9016



RAL 1013



RAL 9006

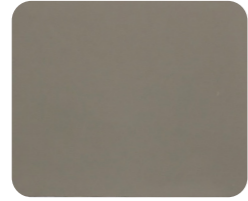

RAL 7006

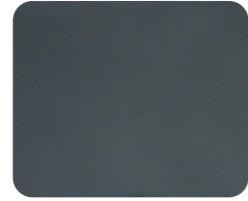

RAL 7016



RAL 9005

exclusive



OGN35



OS561

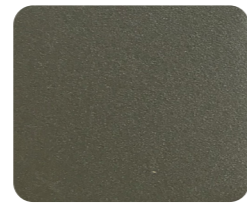

OY395



OGN39



ON617



ON611

texture



ST9010



ST9001



ST1013



ST7039



ST7016



ST8019

The color and gloss level shown in this color swatch should be used only as a guide.
All ral colors are available.

www.umbraoutdoorliving.com.au

info@umbraoutdoorliving.com.au

040 339 88 19

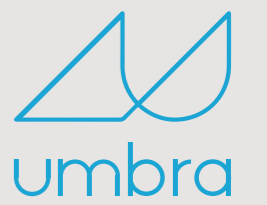

OUTDOOR
LIVING

