



Ceramic
Facade Systems



MADE IN BAVARIA

COVERING ARCHITECTURE WORLDWIDE

The In-house Planning Department or certifications are just two of many good reasons.

As specialist for architectural ceramics, AGROB BUCHTAL offers an extensive portfolio of products and services for modern and future-oriented building and designing with ceramics. The company's history already started in the 18th century. Today, AGROB BUCHTAL is a global player deeply rooted in Germany as traditional location.

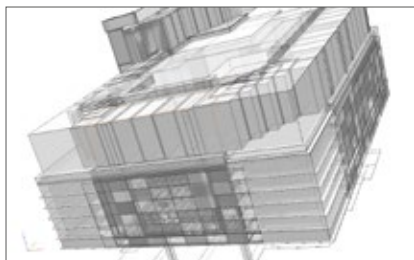

In-house Planning Department.

Specific relief of routine tasks opens up creative scope for specialists who convince in the form of their solution competence and offer technical building consulting on site.

BIM. The provision of BIM-compatible planning optimizes the exchange of information between everyone involved in the building. This makes the planning process more productive – with positive effects on costs, quality and loyalty to deadlines.



Digital print. Modern technology creates facades in line with individual requirements. Accordingly, apart from wood or stone looks exuding a natural effect, metallic glazes are also possible which are resistant to environmental factors.

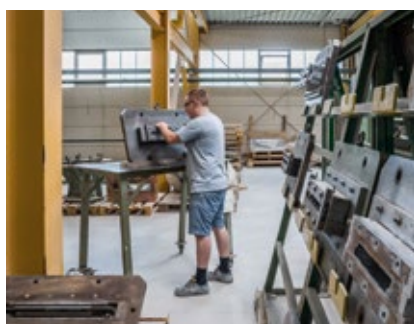

Experience. The innovative strength of AGROB BUCHTAL is based on know-how gleaned by several generations – extending as far back as the 18th century. By offering ceramic facade systems, the specialist for architectural ceramics has been making a name for itself all over the world for more than 40 years.



Colors. The enormous selection of colored glazes includes the harmoniously co-ordinated SpectraView color families as well as a wide range of design surfaces, as glazed or unglazed variants. On request, glazes are also optimized in special colors to ensure maximum freedom of design.

Freedom of design. Additional possibilities associated with individual facade design arise from the use of various formats and surface finishes. Textured facade panels can loosen up expansive areas, for example, and emphasise the character of an entire building.



Ceramics. As a building material which has proved its value for thousands of years, ceramics displays ideal properties: it is non-combustible, resistant to chemicals, light-fast, resistant to pressure, impact and scratches, easy-care and hygienic.

Made in Germany. Modern production facilities, expertly-trained employees and efficient Quality Management are the basis for high-quality products. Ceramic facade systems offered by AGROB BUCHTAL are subject to on-going inspections and are manufactured exclusively in Germany. For guaranteed “Quality made in Germany”.

Sustainability. Ceramics is harmless in terms of building biology. It scores well on account of its unlimited useful life and can be fully recycled.



Surface finishes. The innovative HT surface coating prevents the formation of algae, moss and microbes while the self-washing effect ensures permanently clean facades.



Special solutions. More than 20,000 glaze formulations, digital printing technology and precise water-jet cuts open up unlimited possibilities for design – for new buildings and in stylish renovations of protected buildings.

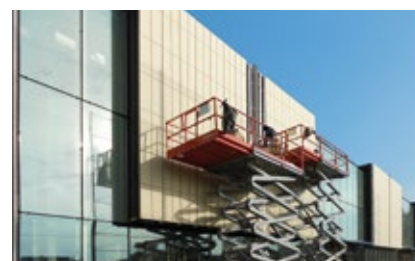

Economic feasibility. Perfect substructures guarantee efficient panel installation. The low panel weight offers advantages in terms of statics, transport and handling.

Certifications. All systems are tested by the Buildings Inspectorate. Specialized product information supporting the auditors facilitates and accelerates certifications in accordance with LEED, DGNB and BREEAM.



Surfaces and profiles

Matt, silky-matt or glossy as well as various three-dimensional cross-sections.

Page 50

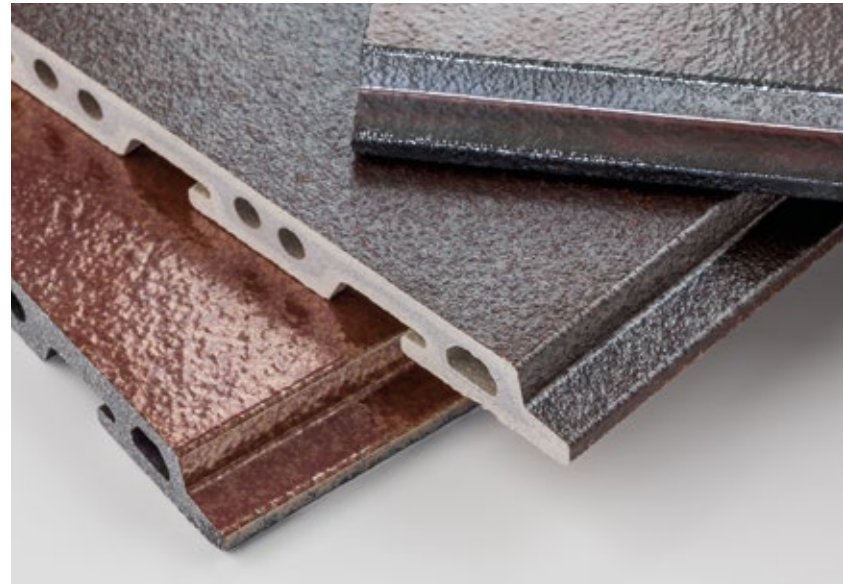

Great color variety

More than 50 colors as well as numerous material looks and metallic glazes.

Page 52



Ceramic special pieces

Rectangular tubes and lamellar elements for setting accents or complete facade designs.

Page 78



Individual solutions

Special developments for individual concepts and unique solutions.

Page 120

CONTENTS



Sustainability

Support in the process and targets for obtaining Green Building certificates.

Page 20



References

Buildings with ceramic facades all over the world.

Page 28

Setting standards – for more than 40 years	8 – 9
The company	10 – 13
Rear-ventilated facades	14 – 19
Green Building	20 – 21
HT coating	22 – 23

KeraTwin®

References	28 – 47
Surfaces and formats	48 – 51
Colors and glazes	52 – 53
Fastening systems, mounting instructions	54 – 75
Detail solutions	76 – 77

KeraShape®

References	80 – 91
Forms, colors and formats	92 – 94
Fastening system, mounting instruction	95
Colors and glazes	96 – 97
Fastening system, mounting instructions	98 – 99

KeraAion®

References	102 – 107
Surfaces and formats	108 – 111
Colors and glazes	112 – 113
Fastening systems, mounting instructions	114 – 117
Detail solutions	118 – 119

KeraYou®

References	122 – 133
------------	-----------

Service

System overview	136 – 137
In-house Planning Department	138 – 139
Reference	140

Ceramic facades for more than 40 years

A facade is far more than just the protective shell of a building. Its design not only characterizes the building itself, but also influences – often visible from far away – the urban environment.

As leading ceramics manufacturer, AGROB BUCHTAL has extensive know-how in all fields of Architectural Ceramics. With this background, the company has been developing and producing ceramic facade systems setting standards for more than four decades: functionally, aesthetically and by their product quality “made in Germany”. Curtain-type, rear-ventilated facades optimizing the energy efficiency and economical balance of buildings play a central part in this context. High competence in building physics results in technically sophisticated substructures, which ensure an efficient mounting and a safe fastening of the panels. These constructions are the connecting element from the wall – via the insulating layer – to the facade cladding and support the realization of creative ideas. The In-House Planning Department is permanently further developing the various systems and accompanies the implementation of individual concepts world-wide – on request also on location at the construction site.



Polytechnikum (polytechnic institute), Hongkong, China / Architect: Messrs. Palmer & Turner



Musée d'Arte Moderne, St. Etienne, France / Architect: Didier Guichard



IMAX, Berlin, Germany / Architect: Renzo Piano

↑
●
1976

↑
●
1987

↑
●
1996



Muhammad Ali Center, Louisville, USA / Architects: Lee H. Skolnick Architecture + Design Partnership



Museum of Cultures, Basel, Switzerland / Architects: Herzog & de Meuron, Basel, Switzerland



Käpylän Posteljooni, Helsinki, Finland / Architect: Anttinen Oiva Architects, Helsinki, Finland

↑
●
2005

↑
●
2010

↑
●
2017



CCQ, Montreal, Canada



Queensland Road, London, Great Britain



Pauley Pavilion, Los Angeles, USA



The Viridian, Boston, USA



Orangerie de Souissi, Rabat, Morocco



Liberty Plaza, Panama City, Panama

Projects all over the world

Thanks to the variety of colors, sizes and surface finishes, supplemented by fastening systems making installation efficient and safe even on complex bases, ceramic facade systems offered by AGROB BUCHTAL have been popular all over the world for decades.

On all inhabited continents, from Canada to Brazil, from Northern Sweden to South Africa, from Russia to China and Australia, the systems comply with various architectural design concepts in a wide variety of cultures and climate zones around the world, whereby special productions are often used for artistic facade design. The range of projects includes hotels, office buildings and hospitals, residential buildings, sports facilities, railway stations and airports. A special part is played by 3D facade ceramics as a means of providing shade in tropical heat.

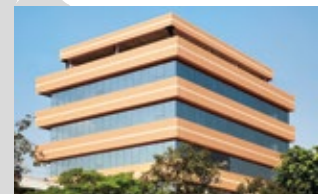

Jurubatuba, Sao Paulo, Brazil



Ministerio de Ciencia, Buenos Aires, Argentina



■ Clarion Hotel, Helsinki, Finland



■ Business Center, Jekatarinburg, Russia



Airport, Düsseldorf, Germany



■ Microsoft Campus, Shanghai, China



Airport, Assuan, Egypt



■ Lee Shan Building, Hong Kong, China



■ Pretoria Tower, South Africa



■ Adventist Hotel, Sydney, Australia



Ceramics: a raw material of architecture

Already for more than 2,000 years, ceramics has been a “raw material of architecture“. Colored tiles and ceramic decorations were already used by the Etruscans in their buildings. The definition of ceramics stands for all inorganic non-metallic materials which are first shaped and fired afterwards.

Clay is the main component of ceramic tile masses and developed as a result of the weathering of rock containing feldspar (e.g. granite) due to exposure to wind, water and the seasonal temperature differences. This weathering took place millions of years ago in the Tertiary period. It is composed of fine-grained minerals, with the clay minerals (sheet silicates) lending the clay its plastic properties.

Due to the special requirements that have to be met with regard to the ceramic manufacturing process and also the product itself, other raw materials such as, for example, feldspar (15-25%), chamotte (10-20%) and kaolin (0-10%) must be added to the clays (50-70%). The preparation comprises the homogeneous mixing of all components.

The obtained mass is further processed in the ceramic manufacturing process.

Concerning the shaping of tiles, basically two methods can be distinguished: on the one hand, the dry-pressing, and on the other hand, the extrusion. In the shaping process, the prepared mass – as granulate or in plastic state – is pressed in or through a mould under very high pressure. The choice of the respective shaping method depends on the desired properties of the finished product. AGROB BUCHTAL uses both methods.



The perfect solution: curtain-type, rear-ventilated ceramic facades

Aesthetics, economic efficiency and sustainability: the combination of these three factors is the basis for the growing success of curtain-type, rear-ventilated ceramic facades. The decisive reason for the technical superiority of these systems is the structural separation of the functions of heat insulation and weather protection.

The ventilated cavity between the ceramic panels and insulating material regulates the building's moisture balance, directing moisture outwards and guaranteeing swift drying of damp exterior walls. The insulating material stays dry and fully functional while the indoor climate is improved. Regardless of the building height and utilisation, mineral insulating materials in heat conduction groups 040 or 035 are usually used for rear-ventilated ceramic facades. As the system permits installation of any thickness of insulation material, the specifications of the Energy Savings Ordinance can also be easily met. The permanently safe

connection between ceramic panels and supporting outer wall is ensured by the substructure where sophisticated constructions make for efficient installation and compensate for uneven surfaces on the walls.

In addition, aluminium substructures play a key role when it comes to lightning protection. As an indestructible material, ceramics not only offers optimum protection from rain and snow – panels and special pieces in a contemporary range of colors also characterise the outer appearance of the building and support the architect in realising his ideas. With their great variety of colors, formats and surface textures, the curtain-type, rear-ventilated facade systems offered by AGROB BUCHTAL represent an ideal basis and maximum freedom of design when planning new buildings or renovating existing ones. And those on the lookout for something special will also find what they are looking for here, as individual special productions are one of the company's strong points.

System: structure and function

Thanks to the air space between the outer facade cladding (ceramics) protecting the building against snow and rain and the insulation (mostly mineral wool), curtain-type, rear-ventilated facade systems improve the indoor climate, save heating costs and conserve natural resources.

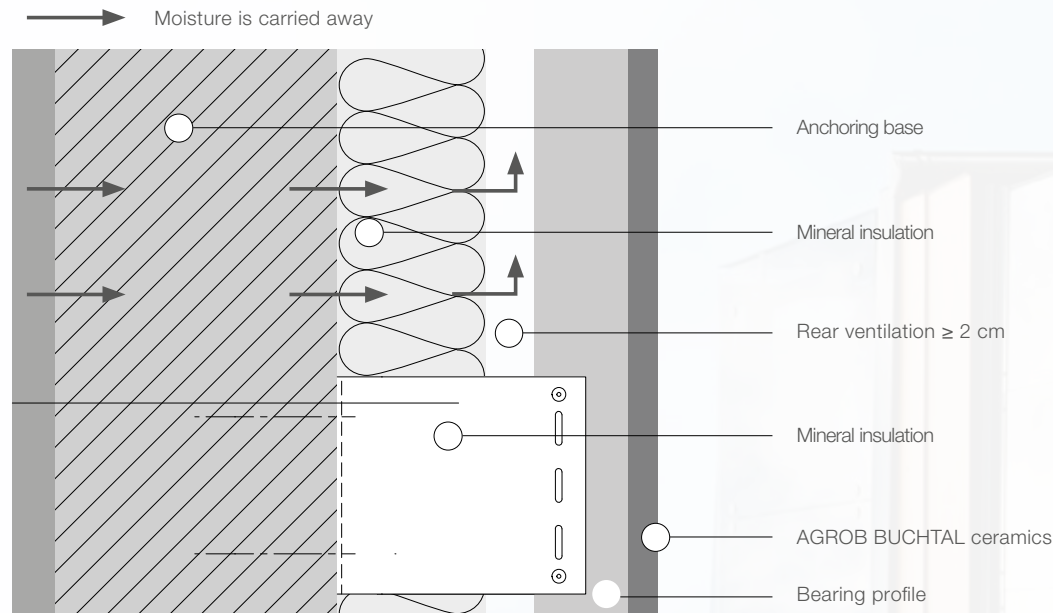



Fabrikkgatan, Bergen, Norway / Architect: Ramboll Norge AS Div Arkitekter / Products: KeraTwin® / Photo: Morten Warvik

Sustainability and conservation of resources also play an increasingly important role when it comes to planning and designing facades. Ceramic curtain-type, rear-ventilated facade systems are practically unbeatable in this area. As the panels are resistant to frost, light- and color-fast, non-combustible and very impact-proof, they have a practically unlimited useful life. Whether glazed or unglazed, the highly-resistant surface made of fired ceramics makes them resistant to extensive soiling such as graffiti. And the HT coating with its self-washing effect also reduces cleaning requirements. When the time comes to demolish the building,

all components of the facade cladding – ceramics, mineral wool and the aluminium used for the substructure – can be easily sorted and redirected to the respective material circuits. On the basis of these material properties, ceramic curtain-type, rear-ventilated facade systems are eminently suitable for use in sustainable construction projects aiming for Green Building certificates such as LEED, BREEAM or DGNB – especially considering AGROB BUCHTAL provides the architects with support during the certification process in the form of documents for auditors which are specially designed for this purpose.

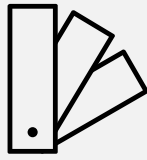

Variety of design

Curtain-type, rear-ventilated facades permit facade design which is independent of the building grid. With a wide selection of materials and sizes and an extensive range of harmoniously co-ordinated colors in various surface finishes, planners and architects have plenty of scope for implementing their ideas. Accordingly, the function and character of the building can be emphasised, attention drawn to significant components or surrounding colors integrated in the design.

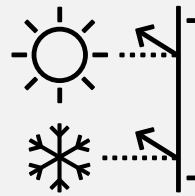

Protection against heat and cold

In combination with mineral insulating materials and an innovative substructure, curtain-type, rear-ventilated facades can achieve any U-value. This ensures good insulation and low heat loss in winter yet good indoor climate conditions in summer. Energy requirements for heating and cooling are reduced. Furthermore, ceramics displays practically no temperature-induced linear expansion – unlike other materials such as metal or composites.

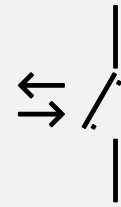

Replacing individual panels

In the event of damage or for any other reason, individual or several panels can be easily removed and replaced without any major effort.

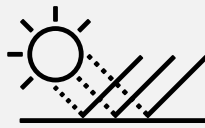

Light- and color-fast

Fired at high temperatures of over 1,200 °C, environmental factors such as heat, cold and solar radiation (UV light) do not have any lasting effect on surface appearances. Colors remain unchanged even after several decades.

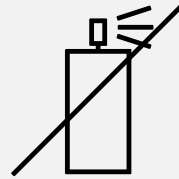

Anti-graffiti

Facade ceramics by AGROB BUCHTAL meet the requirements on cleaning according to ReGG III of the Gütegemeinschaft Anti-Graffiti e.V., whereby the maximum performance class is achieved. This has also been confirmed by an independent test institute.



Sun and visual protection

Solar protective equipment mounted on the outside is most effective in reducing the energy input via translucent layers. Rear-ventilation also offsets surface heating.

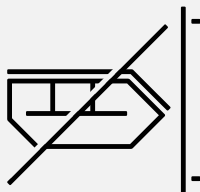

Less waste on site

As the ceramic elements are robust and resistant to weathering factors such as rain and frost, they do not require complex packaging but are secured on standard pallets for delivery to the building site. This accelerates on-site processes and means that little waste is incurred which, in turn, needs to be disposed of.

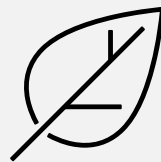

Sustainability

Curtain-type, rear-ventilated facades are suitable for both new buildings and renovations, and permit a lengthy useful life or extend the useful life of existing buildings. The HT coating with a self-washing effect supplied by AGROB BUCHTAL ensures a low cleaning effort and improves the quality of air in the vicinity of the building. All components can be easily recycled after de-construction.

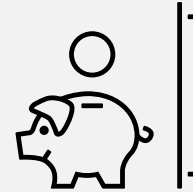

Economic feasibility

The curtain-type, rear-ventilated facade design protects the components underneath from a wide variety of environmental factors. This results in a long useful life on the part of the entire construction, low susceptibility to damage, comparably low maintenance costs, cost stability during the planning phase, and installation independent of the weather.



Naabtal-Realschule (secondary school), Nabburg, Germany / Architect: Architekturbüro Schönberger / Products: KeraTwin® / Photo: Atelier Bürger



Fire safety

Fire safety experts rate curtain-type, rear-ventilated facades as very safe in terms of technical fire safety. Free selection of the system components makes it possible to meet all technical fire safety requirements. As a general rule, the following applies: all components of curtain-type, rear-ventilated facades must be made of non-combustible materials. The DIN 18516-1 and reference to Annex 2.6/11 regulate fire safety for curtain-type, rear-ventilated facades. Detailed information on measures, precautions and rules can also be found in the applicable state construction laws of the 16 German states (LBO), in the general DIN and VDE provisions as well as in the information provided by building supervision.

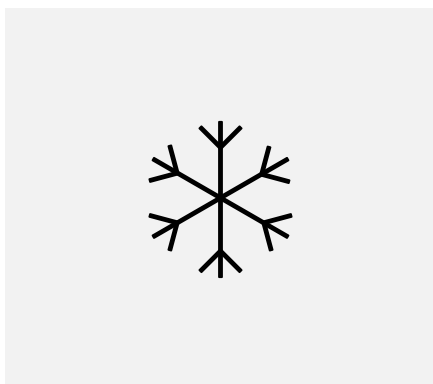

Resistance to frost

Extruded stoneware panels are fired at a firing temperature of approx. 1,260 °C and are extremely resilient. This also includes frost resistance in accordance with DIN ISO 10545-12. In test procedures, the panels are saturated with water before testing for soundness under vacuum after 100 frost-thaw cycles.

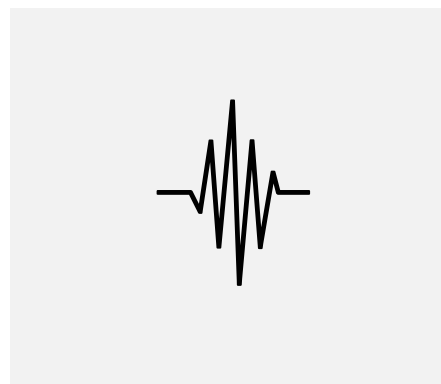

Earthquake-safe

All products are constantly tested at recognised material testing institutes in Germany and abroad. Specific national certificates governing earthquake stability, for example, are available. On request, copies of these certificates and approvals can be made available at any time.

Safety first

The ceramic facades offered by AGROB BUCHTAL are not only efficient and inexpensive to install, they also meet even increased requirements on safety in their capacity as sophisticated systems – in both new buildings and renovations.

Ceramic facade elements score particularly well when it comes to meeting fire safety specifications: this external wall cladding corresponds

with the highest classification of “non-combustible” and also meets the additional requirements governing smoke production and flaming droplets/particles as specified by the DIN EN 13501 standard. Even in the case of a fire, no vapours or toxic gases are released. As a building material, facade ceramics is regarded as displaying a recognised and stable performance in terms of its reaction to fire as it does not contain any organic material. When planners or contractors choose non-

combustible mineral insulation and consider installing fire barriers, the result is an overall construction offering maximum fire safety. Not that any compromises need to be made in terms of design either: based on its material, ceramics already complies with the “non-combustible” requirement with the result that the extensive range of colors, sizes, surface finishes and ceramic special pieces is available in full for creative solutions with a high degree of individuality and design quality.

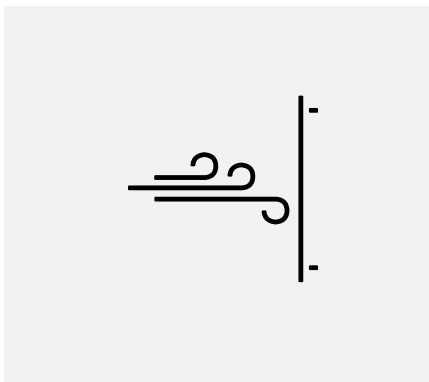

Design loads

As a static link, the substructure absorbs all loads and directs them safely into the anchor base. The cladding fastenings secured to the substructure link the system components without technical restraint and transfer all loads.

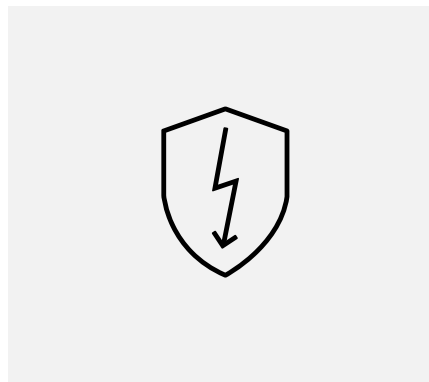

Lightning protection

The system has also proved its worth during thunder and lightning storms. The metal substructures conduct lightning strikes away or can be combined with lightning protection devices. Accordingly, lightning is conducted to earth and also forms an electromagnetic shield protecting the electronics inside the building.

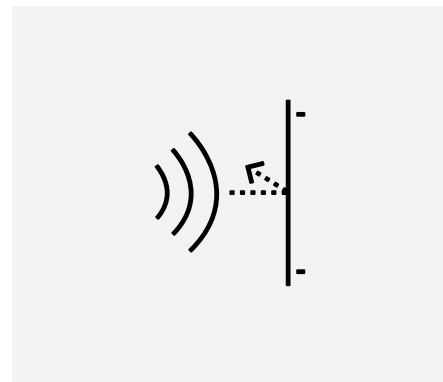

Noise protection

Curtain-type, rear-ventilated facades not only reduce thermal loss; they also protect the building interior from noise immissions. Thanks to the great absorption capacity of the mineral insulating materials combined with the extensive external cladding, a sound reduction index can be achieved which is up to 14 dB higher.

Ceramic tiles for sustainable buildings



Information for auditors
by AGROB BUCHTAL

All building certification systems give building materials high priority at the assessment. For builders, this means that already the choice of the appropriate material may have a positive influence on a certification process and thus also on the sustainability performance of a building.

The factor “material” is relevant in all of the four cycle phases, i.e. during the manufacturing, the construction, the operating and the deconstruction phase of the building. In the manufacturing phase, the question is how sustainably the respective building materials are extracted and/or produced or with which energy input they are transported to the respective construction site. In the operating phase, the focus is above all on the influence of materials used on the health and the well-being of the users of the building as well as on technical and energy-related properties.

Making all relevant product properties transparent is advantageous already during the certification. Because the simpler and clearer all the information is prepared, the easier is it for the auditor to assess the material with regard to its effects on the building. That is why AGROB BUCHTAL has compiled separate auditors’ information for the internationally established certification systems LEED, BREEAM and DGNB in a brochure.

LEED

This green building label enjoys the greatest international popularity. LEED-certified buildings can be found in 135 countries around the world. Almost 54,000 buildings world-wide are certified or at least registered in accordance with the LEED standard, of which more than 44,000 are in the USA. Around 48 per cent of all new American construction projects are developed as green LEED buildings. This percentage is to increase to 58% by 2015. The American sustainability label is also extremely successful abroad: in the People's Republic of China, for example, more than 1,100 buildings comply with the LEED standard while there are over 800 in the United Arab Emirates and more than 600 in Brazil. In Germany, many property owners also rely on the LEED label with almost 300 LEEDcertified buildings scattered between northern Germany and Lake Geneva in the south. The rating system involves points with 69 criteria in seven categories: Sustainable construction sites, Water efficiency, Energy and atmosphere, Materials and resources, Air quality and buildings, Innovative design and Regional priority. Many large international corporations have made LEED certifications obligatory for new rentals or construction of new company buildings.

DGNB

The certification system applied by the Deutsche Gesellschaft für Nachhaltiges Bauen (German Sustainable Building Council, DGNB) was launched in 2007. This masterpiece of German engineering science raises the benchmark for some – especially technical – criteria when compared to the British label. It is more exact which means it is practically impossible to achieve a 100% rating. Overall assessment incorporates five segments: Ecological quality, Economic quality, Socio-cultural and functional quality, Technical quality and Process quality. For each application, the certificate also demands a comprehensive analysis of life cycle costs in accordance with standardised criteria, a life cycle assessment and a decommissioning concept. Meanwhile, around 200 properties have been certified, more than 150 of which are to be found in Germany.

BREEAM

The mother of all sustainability labels for property although meanwhile overtaken by LEED in terms of popularity. Around 250,000 buildings world-wide comply with the requirements of the British sustainability catalogue, most of which can be found in the home of the BREEAM label, Great Britain, where the astonishing success of climate-friendly property is also largely due to state regulations: all new residential buildings must satisfy the BREEAM Code for Sustainable Homes. In Germany, too, the BREEAM label is often the green building standard of choice. Developed for rating entire properties, the BREEAM In-Use Certificate evaluating the environmental compatibility of existing property has also been available on the German market since 2012 with ratings being awarded in the following categories: Energy, Water, Land use and ecology, Health and well-being, Transport, Materials and Pollution.

COMMUNICATION RELATING TO BUILDING CERTIFICATIONS – THE PRINCIPLE

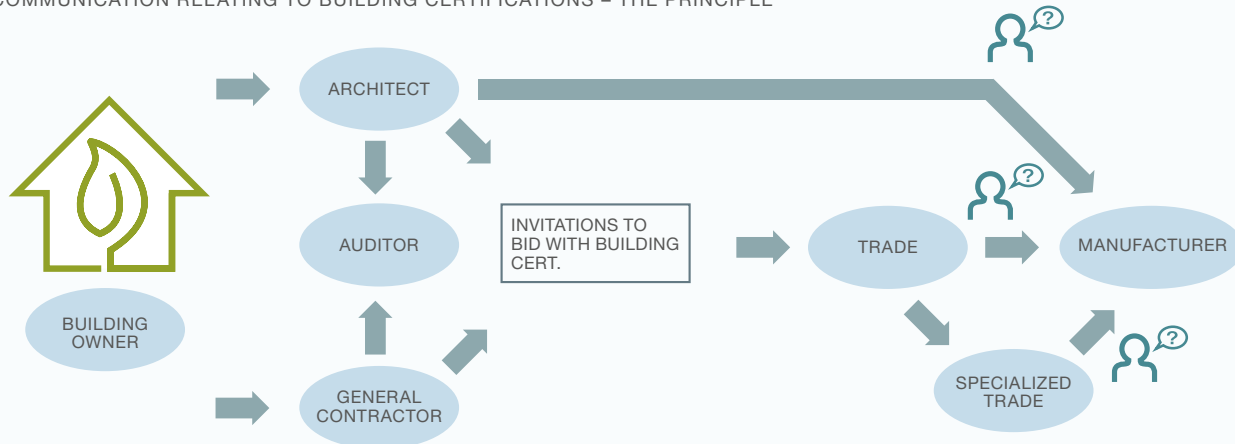



Pauley Pavilion, Los Angeles, USA / Architect: NBBJ
Photo: RMA Photography Inc. / **LEED GOLD**



The Viridian, Boston, USA / Architect: Bruner/Cott & Associates
Photo: Fred Clements / **LEED GOLD**



Orchard Hotel, Nottingham, Great Britain / Architect: RHWL Architects /
Photo: Martine Hamilton Knight Photography / **BREEAM EXCELLENT**



Société de Transport de Montréal, Montreal, Canada / Architect: Lemay /
Photo: Marcin Wozniak / **LEED GOLD**



Finchley Memorial Hospital, London, Great Britain / Architect: Murphey
Philipps Architects / Photo: Benedict Luxmoore / **BREEAM EXCELLENT**



Alterszentrum Sonnenhof (old people's home), Wil, Switzerland / Architect:
Meier Hug Architekten / Photo: Adriano Faragulo / **MINERGIE-STANDARD**

HT surface: Facades with self-washing effect

Light activates

Titanium dioxide is baked onto the ceramic surface at high temperature. As catalyst, it effects a reaction activated by light with oxygen and air humidity. In this way, activated oxygen and a hydrophilic, water-friendly surface are produced. The activated oxygen now fulfils two decisive functions:

1. On the surface of the ceramics, it decomposes microorganisms such as fungi, algae, moss or germs and inhibits their growth. This saves maintenance costs in the life cycle of a building.
2. Air pollutants such as, for example, nitrogen oxides from traffic or industry are reduced. HT permanently improves the ambient air of the building.

Rain cleans

The hydrophilic ceramic surface effects that rain drops spread to form a thin film and infiltrate the dirt. This self-washing effect prevents the adherence of dirt. This minimizes the cleaning costs.

Active support at every weather – sun and rain perform the effective and environment-friendly cleaning free of charge! HT keeps facades clean.



Self-washing effect with HT

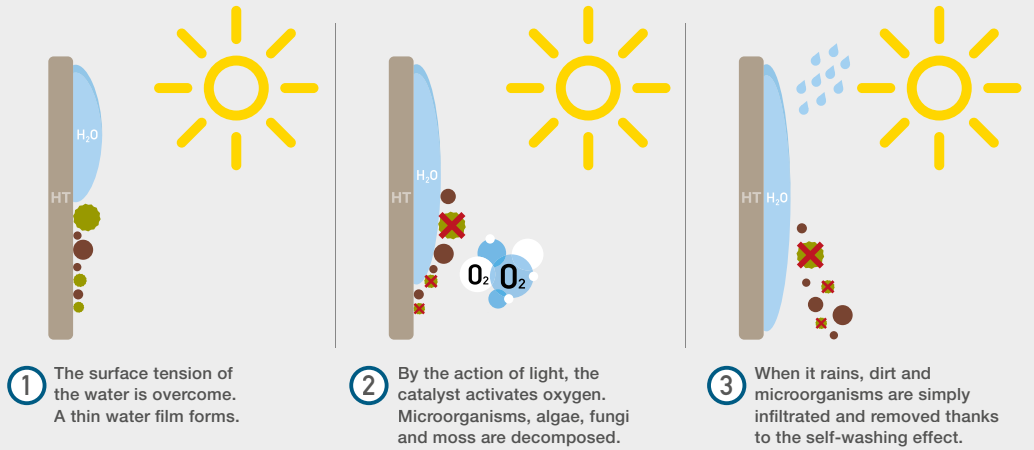

Renowned test institutes confirm the effects of HT.



Further information:
www.agrob-buchtal.de
→ HT coating

THREE SYSTEMS FOR ALL FACADES

Protecting buildings against atmospheric influences is one of the classic functions of any facade cladding. Today, in consideration of the climate and natural resources, demanding energetic standards also need to be complied with and can be best met with curtain-type, rear-ventilated facades. This not only applies for new buildings, but also for the renovation of existing buildings worth conserving.

With the three systems KeraTwin®, KerAion® and KeraShape® – all of them made of extruded ceramics – AGROB BUCHTAL offers the planning architect the possibility to achieve his individual solution. KerAion®, the classic among ceramic facade systems, has been installed successfully all over the world for decades. Apart from the well-known advantages of ceramics as a material, it is above all the sophisticated technique which speaks in favour of this system: KerAion® facades conform to standards and official approvals and, thanks to their practically unlimited useful life, are also very economical. With their well-balanced range of colors, variety of sizes, and project-specific special productions, they also lend buildings with large surfaces an individual look. And the square large-size formats ranging from 60 x 60 cm to 120 x 120 cm with a panel thickness of only 8 mm offer additional design possibilities.

Developed as an economical and design alternative to KerAion®, KeraTwin® is convincing thanks to its architectural versatility and visual variety. Apart from the great selection of sizes with standard heights of 15 to 60 cm and lengths of up to 180 cm, a wide and varied range of harmoniously co-ordinated colors is also available – and rounded off by vivid contrasting colors. Furthermore, the system offers various fastening and design options with installation possible in joint cuts, with or without joint profiles. The panels can be arranged horizontally, vertically and in various bond patterns. Installation is possible on practically any base, including ceilings, in a single panel geometry and a single panel thickness.

AGROB BUCHTAL supplies architects with a versatile product in the form of KeraShape®: the rectangular tubes, lamellar elements and corner profiles can be used as sun or visual protection, for the aesthetic design of corners and projections, which is also safe in terms of construction physics, or for making large facade surfaces appear less monotonous by giving them a visual rhythm.





KeraTwin®

The particularly efficient laying and practically unlimited application possibilities thanks to diverse fastening systems speak in favour of KeraTwin®.

Further system advantages:

- great variety of sizes up to large formats of 60 x 180 cm
- panels available both glazed and unglazed
- particularly wide and varied range of colors
- easy to clean and environment friendly thanks to the HT coating



KeraShape®

With its diverse profiles, KeraShape® fulfils numerous functions – from the protection against the sun and view to the three-dimensional design of facades.

Further system advantages:

- suitable for horizontal and vertical mounting
- ideal for the execution of corners and projections
- wide range of colors, glazed and unglazed
- elements in lengths of up to 180 cm



KerAion®

The classic, which has proved itself for decades, also offers square formats and lends large-size facades a characteristic look.

Further system advantages:

- great variety of sizes up to the large format of 120 x 120 cm
- advanced technique developed in the course of decades
- wide range of colored glazes with HT coating
- statically advantageous thanks to low panel weight

KERATWIN®

CERAMIC SYSTEM



With its variety of colors, formats and surface finishes, KeraTwin® offers the architect enormous freedom of design. And as diverse fastening alternatives ensure technical and structural versatility, this system offers the appropriate solution to any challenge – even on difficult bases.

As a facade system with the widest variety of colors, KeraTwin® enables any architect to realise his creative ideas. Therefore, apart from the “SpectraView” range of colors comprising nine harmoniously co-ordinated color families and contrasting colors, the “Natura unglazed”, “Design unglazed” and “Design glazed” color systems are also available. On request, the panels are also supplied with profiles which, due to their three-dimensional texture, can make large facades appear less monotonous and lend an entire building a distinctive character. The joints are realised in such a way that the construction is optimally protected against driving rain. With their relatively low weight of 32 kg/m², the panels are easy to transport and install.

The KeraTwin® system variants essentially differ in terms of their fastenings which depend on the requirements of the specific project. The vertical K20 system rail, for example, offers extensive freedom of design and a wide range of accessories. As the panels are simply hung on the system rail, no additional tools are required for installation. Even faster and more efficient laying is possible using the innovative K20 T-profile which requires fewer individual components in the substructure. The vertical K20 Omega profile has proved itself as a specialist for efficient installation on difficult bases, e.g. walls with post-and-beam construction, while the K20 clamp system permits mounting of the panels not only in a horizontal and vertical direction, but also on ceilings. The new OmegaS system variant offers further possibilities: large panels of up to 60 x 180 cm can be mounted vertically.

Another innovation is represented by the OmegaV system variant for installation in any bond patterns.



Orchard Hotel, Nottingham, Great Britain /
Architect: RHWL Architects / Products: KeraTwin® /
Photo: Martine Hamilton Knight Photography

Facelift for a university

In recent years, the North American construction market has experienced a sharp increase in the ratio of renovations and expansions to new construction projects. In part this is a by-product of a greener approach to design, because improving the energy performance of existing buildings generally results in lower total energy costs than new construction.



Pauley Pavilion, University of California, Los Angeles, USA / Architects: NBBJ, Los Angeles, USA / Products: KeraTwin® / Photos: RMA Photography Inc.



KeraTwin®





This trend, however, also reflects an uncertain economy and the densification of urban centres. A 2008 report by California's Lawrence Berkeley National Laboratory (Report LBNL-291) forecasts that at least half of the buildings that will be in use in developed economies by 2050 have already been built, and a 2003 survey by the U.S. Energy Information Agency found that buildings more than 20 years old account for more than 72 per cent of the nation's floor-stock.

Lighter in weight and more cost-effective than many other construction materials, the durable, color-fast ceramic tile is highly suitable for many projects involving the transformation of an existing building. One award-winning example, the Pauley Pavilion renovation and expansion, was completed at the University of California, Los Angeles (UCLA) campus in

2012. Home to UCLA's fabled Bruins basketball team, the original Pauley Pavilion, by Welton Becket, dates from 1965. Tasked with adding one thousand additional seats to what had previously been a 12,000-seat arena and significantly increasing both fan amenity space and team space, the architectural firm NBBJ faced several challenges. A desire to retain the original arena's distinctive V-truss roof structure precluded the possibility of building up, and the proximity of other buildings limited the scope for building outward. NBBJ's solution involved building new locker room, support and event space below grade and creating an enclosed concourse at grade that slopes outward along the original building's northern edge. Glass, steel and AGROB BUCHTAL's ceramic facade system KeraTwin® are the principal materials used to create this elegant new concourse. Athletic Business jurors described the Pauley Pavilion's transformation as "beautifully detailed" and "a masterful makeover" when they bestowed a 2013 Facilities of Merit award on it.



KeraTwin®



Pauley Pavilion, University of California, Los Angeles, USA / Architects: NBBJ, Los Angeles, USA / Year: 2012 / Products: KeraTwin® (K20), special color cream-beige / Photos: RMA Photography Inc.



Piliamiestis Brasta, Lithuania / Architect: UAB Kita kryptis, Kaunas, Lithuania / Year: 2017 /
Products: KeraTwin® (K20) / Photos: Leonas Garbačas

Castle view

Near the confluence of Neman and Neris Rivers, the architectural office Kita Kryptis was commissioned to design three residential buildings. So far, two of the three have been built, as part of a larger development of this area into a residential district.

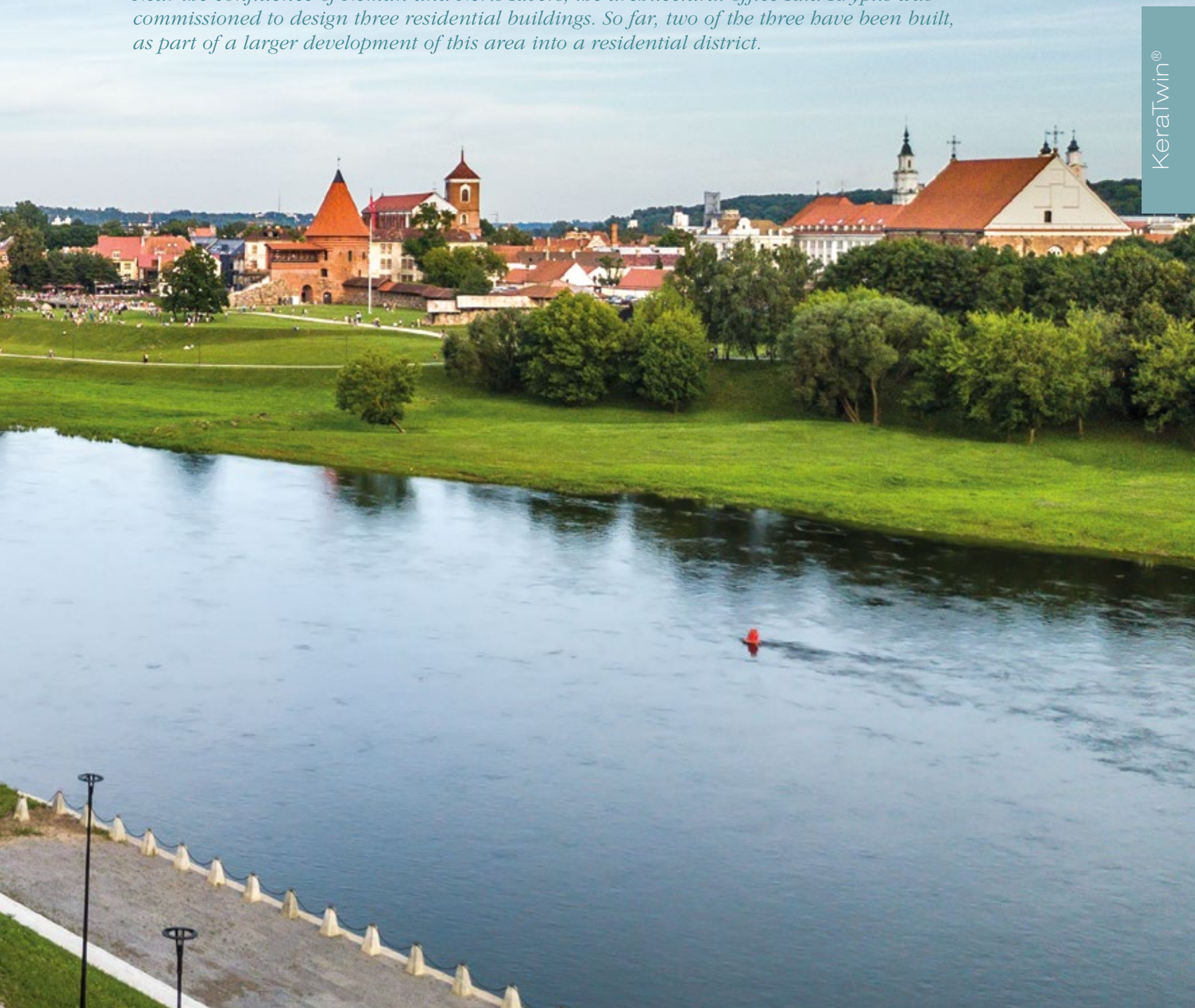



The two apartment buildings are placed in what is becoming the new Piliamiestis quarter, located opposite the monumental Old Castle of Kaunas. This historical Castle is not only centre stage in many of the views from the apartments, but it also formed a major reference for the architecture of the new buildings. On the request of the Kaunas city architect, Kita Kryptis's Tomas Kriauciūnas has mixed and matched the colors of his buildings with those of the castle. For this, he has used AGROB BUCHTAL's KeraTwin® K20 tiles, finished with a self-washing and air pollutants eliminating HT coating.

The castle has walls made out of a mix of stone and bricks, and roofs covered with terra-cotta tiles. The brown facades

of the apartment buildings do not exactly mimic the colors of the castle, but they are certainly taking cues from it. In a subtle way, Kriauciūnas has managed not only to reference the color of the Old Castle but also the texture of its walls. The facades echo the robustness and unevenness of the castle's rusticated walls in the alternating use of tiles with and without grooves, in the variation of the dimensions of the ceramic tiles and in the nuanced color differences between them. In this way, he has given a tactile materiality to his architecture. Despite the evident differences in appearance and history between the Old Castle and the new residential architecture on either side of the river, Kriauciūnas has achieved a natural, yet novel understanding between past and present.



KeraTwin®

Transformative tower

Like many other cities, Boston currently experiences a densification of its urban core. The effect of this is clearly visible in Fenway Park, which used to be a predominantly low-rise district. The contrast between the 20-storey Viridian, named after a chrome green pigment, and its two-storey neighbours is indicative of the scale of the transformation which is taking place there.

Bruner/Cott Architects and Planners have carefully mitigated this shift in dimensions by dividing up the building into smaller volumes. Moreover, by including programme which benefits the community, they have ensured that the building becomes an integral part of the neighbourhood.

The building has glass balcony screens whose color comes close to the viridian it is named after, but it isn't this green that is determining the overall impression of this architecture. Crucial for the appearance of the building is the subdued cladding in terra-cotta tiles of AGROB BUCHTAL. The Viridian consists of a podium with retail, the Fenway Community Centre, and a large three-storey lobby. Above this podium are two towers with 342 apartments, ranging from micro units to three-bedrooms, catering for a diverse demographics of professionals, students, young families and empty-nesters.

Between the underground parking and the communal rooftop terraces on the fifteenth and twentieth floors, the Viridian also contains a fitness centre, resident lounges, and two 'work labs' with computer bars and conference rooms.

To mitigate this sizable addition to cityscape, Bruner/Cott Architects and Planners have not only broken up the volume in smaller ones, but also created a variation in color and composition to set them even more apart. Slight color variations of the tiles within the main volume help to further scale down the building and to enliven its architecture.



Each volume is covered in a terra-cotta rain screen in different natural earthy colors, which harmonize with the range of reds, browns and yellows of Boston's traditional buildings in brick. While the Viridian is in every sense the product of the twenty-first century, its reliance on the enduring quality of ceramic products situates this architecture in a venerable tradition of timeless city building.

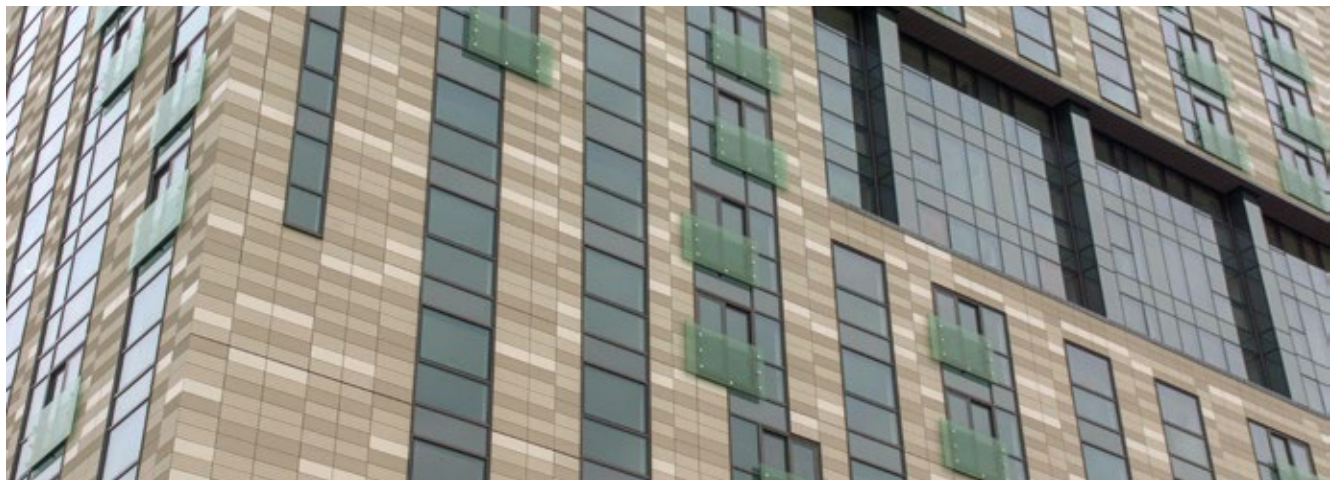



KeraTwin®



The Viridian, Boston, USA / Architect: Bruner/Cott & Associates, Cambridge, USA /
Year: 2015 / Products: KeraTwin® (K20) / Photos: Fred Clements, cb-products



CITY VILLAGE

Earthy and airy

Rachel Haugh, one of the name-givers of SimpsonHaugh, has noted that there are two vital requirements for the design of a high-rise. One is to ensure it is well-connected on street level, and the other that it adds something to the skyline.

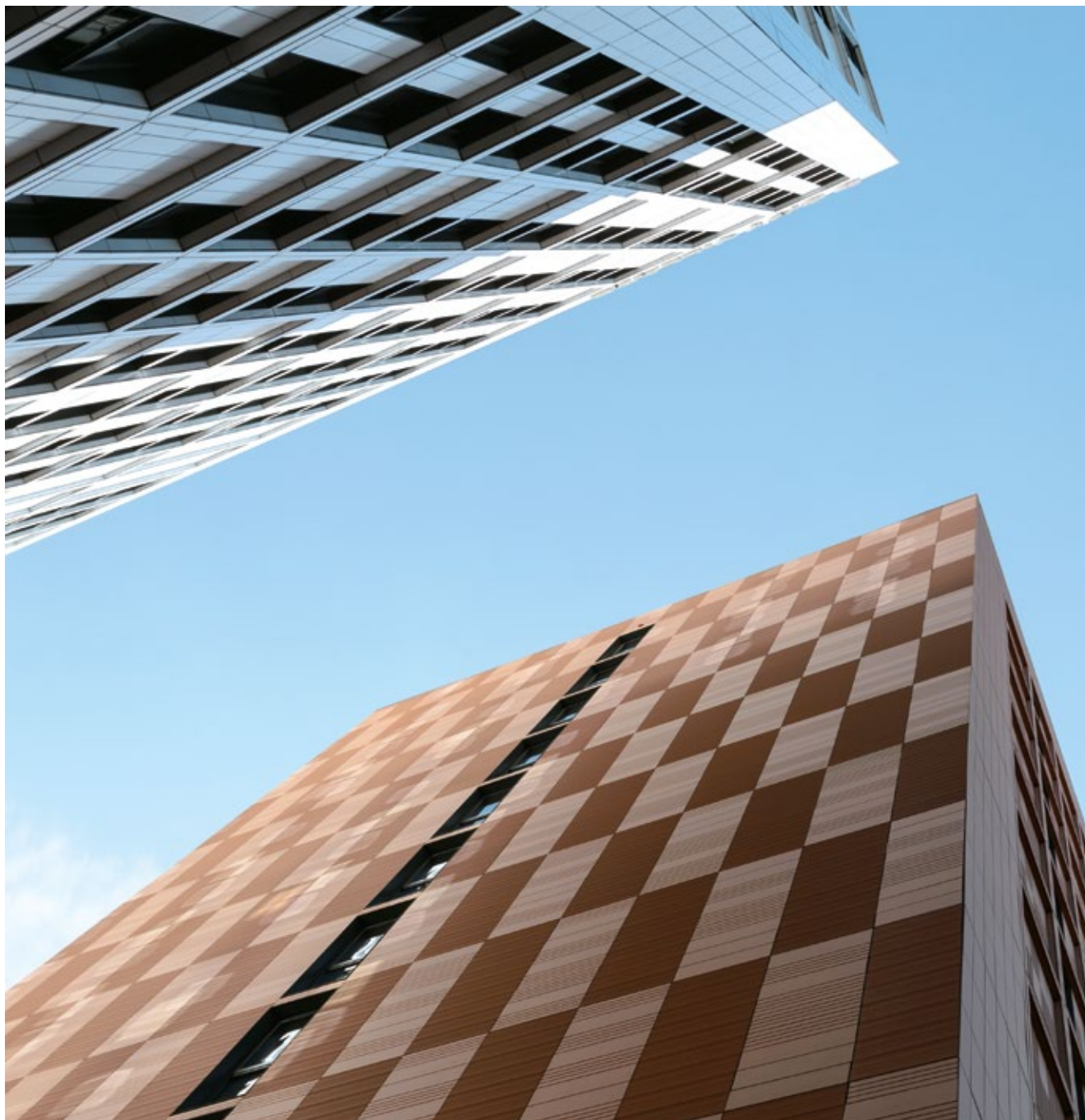

This might be true in general, but in the case of the 20-storey complex of Belgrade Plaza in Coventry, it is equally important what happens architecturally in between the bottom and the top. The complex Haugh and Ian Simpson designed as part of the urban regeneration of the area near the Belgrade Theatre is situated in the northwestern part of the centre of Coventry. The city has endured a massive destruction during the Second World War and has subsequently been rebuilt in the 1950s and 60s in a tepid, reconciliatory style, combining concrete and brick. The Belgrade Plaza complex contains retail space on street level, 49 apartments and a variety of different types of housing for 600 students.

This complex obviously stands out due to its height in a predominantly low-rise cityscape, which is determined by the elevated ring road and the postwar reconstruction architecture of the centre of Coventry itself. In the direct surroundings of Belgrade Plaza there is not only the theatre but also some scattered detached and semi-detached housing that has survived the bombing in the 1940s. Simpson and Haugh have managed to blend in their intervention in this rather disparate mix of buildings that forms the context they had to work in, and with. To mitigate the change of scale imposed by the high-rise, the foot of the tower consists of additional low- and mid-rise volumes, with a gridded pattern to further break up their mass. The facades of these lower volumes are clad with KeraTwin® facade ceramics of earthy shades, harmonizing with the brick buildings in the area. The tower is finished in



light-blue, glazed terra-cotta tiles with a glossy coating. The effect of these light-hued ceramics and their reflective finish is that it makes the tower appear lighter, and lighting it up, adding a welcome brightness to Coventry.

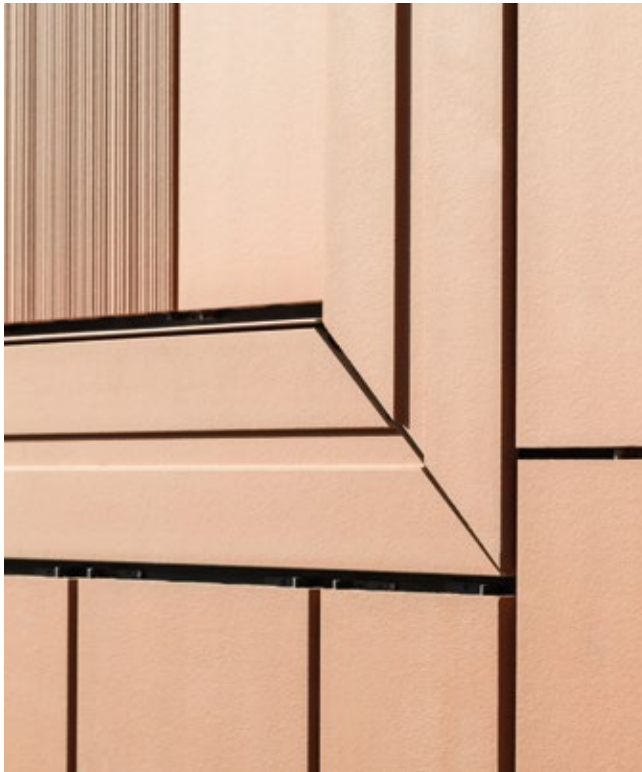

The cladding of the projections attributing the facade its characteristic structure required special customised production. Hence, AGROB BUCHTAL not only designed special panels and cross-sections: assembly was also based on an individual and detailed solution featuring a combination of K20 clamps and K20 system profiles. Based on detailed drawings, the arrow-shaped panels for the intersections were cut precisely in the factory in various sizes.



KeraTwin®



Pretoria Tower, South Africa / Architect: Boogertman + Partners, Pretoria /
Year: 2014 / Products: KeraTwin®, special color / Photos: Roger Skudder

Pretorias landmark with a new appearance

When the Pretoria Tower was completed in 1978, it was not only the first skyscraper in the rapidly-growing city of Pretoria; it was also regarded as a prime example of progressive architecture throughout South Africa. Meanwhile somewhat outdated, the building has now been given a new facade complying with current construction standards yet maintaining the original appearance as consciously as possible.

Previously known as the "Volkskas Building" on the corner of Pretorius Street and Lilian Ngoyi Street, the building is not only regarded as the city's most distinctive landmark but also serves as a visual orientation point for public spaces throughout the central business district.

In the course of more than three decades, the Pretoria Tower has become a characteristic element in the city's history. Today, it is protected by the provisions of the "National Heritage Resources Act" as an "outstanding architectural achievement of a remarkable architect". That is why the initiative for the restoration of the Tower founded in 2010 attached great importance to a renewal of the facade in such a subtle manner that the look, the shape and the structure of

the building were basically maintained and the aesthetic intentions of the architects could be realized. The total volume and the building mass distribution of the building also should remain unchanged, if possible. However, an analysis of the architecture office Boogertman + Partners showed that it was almost impossible to retain and restore the existing facade made of glazed ceramic mosaic tiles and to meet the current requirements with regard to construction technique in this way. That is why one decided in favour of a rear-ventilated facade realized with 20 mm thick KeraTwin® panels, whose glaze color was adapted to the original look as exactly as possible. The visible aluminium substructure profiles were powder-coated accordingly. In total, AGROB BUCHTAL supplied 31,000 m² of KeraTwin® panels and the appropriate accessories to Pretoria for installation.

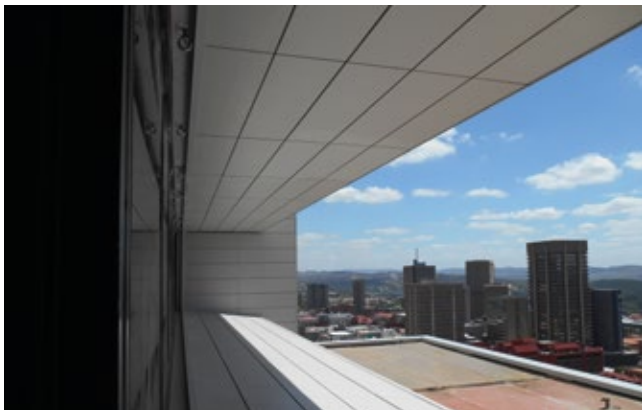



Société de transport de Montréal (STM), Montreal, Canada / Architects: Lemay, Montreal, Canada /
Year: 2015 / Products: KeraTwin® / Photos: Marcin Wozniak

LEED®-certified transport centre

Although North America lagged behind Europe for many decades in sustainable building practices, in recent years burgeoning interest in LEED® and other green building rating systems has brought the two continents into closer alignment. In Montreal, Quebec, the Société de transport de Montréal (STM) recently opened a transport center that earned a LEED® Gold rating.

The Stinson Transport centre, designed by Lemay, will have a smaller environmental footprint than the facility it replaces, even though it is four times the size of its predecessor.

Stretching the length of seven football fields, STM's first roof-covered transport centre minimises the environmental and sensory impact of the 300 buses it can accommodate. Treating the roof as a 'fifth facade' was key to Lemay's sleight of hand: residents of high-rise towers bordering the site gaze

down on a visually engaging patchwork of ventilation skylights and green roof expanses, traversed by the yellow oblong roof demarcating the administrative portion of the facility. Natural light streaming through the skylights permeates the transport centre, and approximately 85 per cent of the heat generated by the vehicles and the maintenance areas is reused for heating and air conditioning. The environmentally responsible materials specified for this project include 2,300 m² of AGROB BUCHTAL ceramic tiles comprising part of the building envelope.



Ceramic facade systems for sustainable renovation

The world-wide trend towards urbanization continues. New town dwellers need housing space, but hardly any areas for new buildings are available today. That is why densification and gentrification have become more and more important during the last years. In this situation, ceramic facade systems offer decisive advantages.

Structural measures at existing buildings open up new chances for future-oriented urban planning: formerly neglected urban districts are becoming attractive residential quarters, and even historic buildings meet the increased requirements of the energy balance after energy-efficient renovation. That is why the number of renovation projects is already exceeding the volume of new buildings in many places. Ceramic facade systems installed on the old facade like a second shell provide a sustainable solution advantageous in terms of energy efficiency and

aesthetics. In this way, diverse energy saving requirements can be met, as the gap between old and new facade provides space for insulation layers of any thickness. In addition, curtain-type facades offer ideal conditions for the visual enhancement of buildings, as they also permit a building grid independent of the original structure of the building. And the positive effects on the quality of living also speak in favour of this type of renovation. Because thanks to the decoupling of the outer shell from the building structure, the living spaces remain cool in summer and warm in winter.

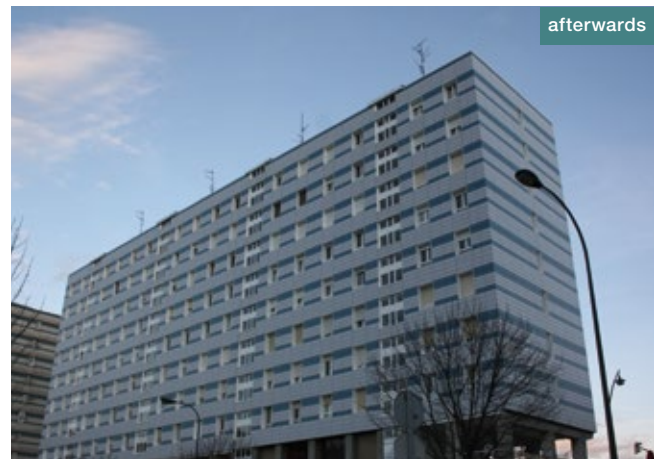

Residential building Av. Julian Gaiarre, Bilbao, Spain / Year: 2013 / Products: KeraTwin®

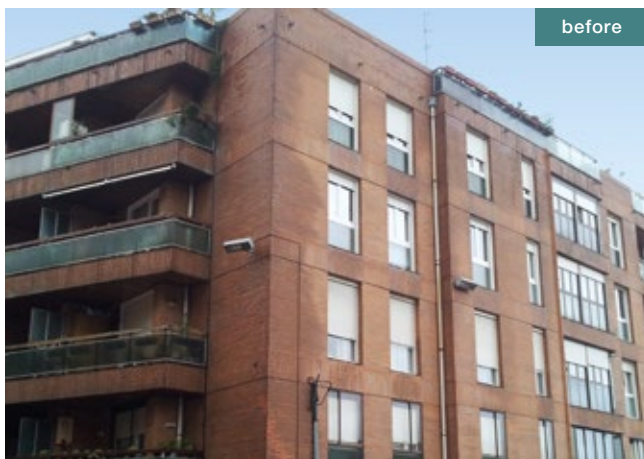

Residential building c/Juan Bautista Uribarri, Bilbao, Spain / Year: 2015 / Products: KeraTwin®



KeraTwin®

Residential building Av. Julian Gaiarre, Bilbao, Spain / Year: 2015 / Products: KeraTwin®

Surfaces and formats for KeraTwin®

The KeraTwin® system offers additional options in terms of surface finish. In addition to the glossy, silky-matt or unglazed surfaces, panels are now also available which benefit from the new technical possibilities offered by digital printing in order to create even more natural and lively facade areas or to achieve highlights.

For example, stone or wood looks can be realised which intimate great depth while this method sees the advantages of ceramic as a material being retained in full. The same also applies for the new metallic surface finishes which open up incredible design options for ceramic facades.



KeraTwin®

KeraTwin® K20



Smooth



Grooved panel

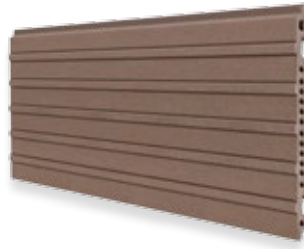

Grooved panel positive

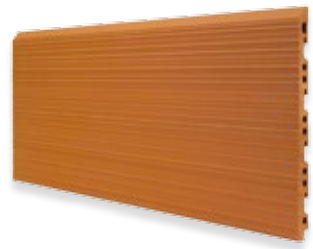

Stripy pattern



Shed profile



Brushed surface



Sine wave



New Wave



Extruded Ceramic Panels, Precision, DIN EN 14411, group Alla, glazed/unglazed (GL/U GL) (small-/large-size stoneware panels), 20 mm thick, 32 kg/m²

Lengths of up to 1,800 mm (in 1 mm steps)

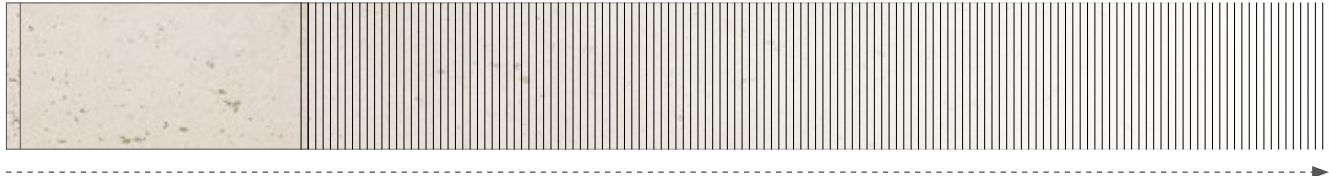

Length of up to 900 mm up to 1.200 mm up to 1.500 mm up to 1.800 mm

Height 150 mm 175 mm 200 mm 225 mm 250 mm 275 mm 300 mm 325 mm 350 mm 375 mm 400 mm 450 mm 500 mm 550 mm 600 mm

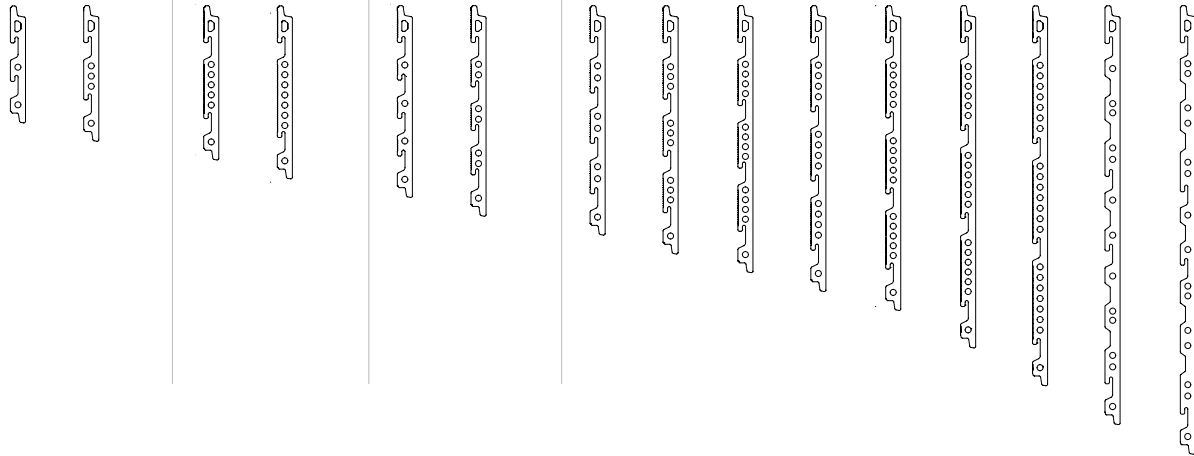







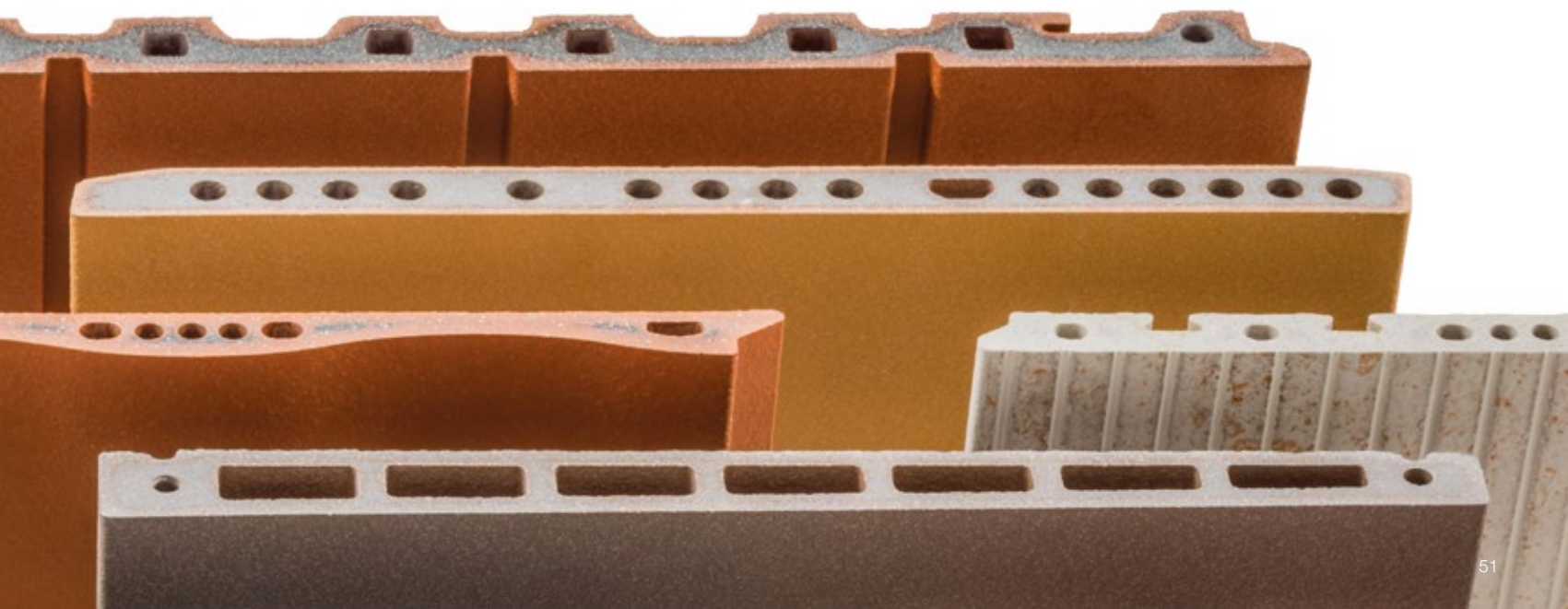







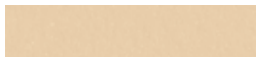

























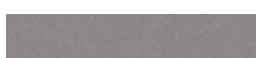
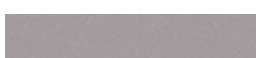



Schematic diagram: production-related deviations possible in individual cases; exact panel cross-section on request.

In addition to the variants shown, other, individual developments are possible on request.

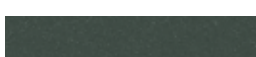

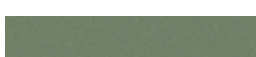

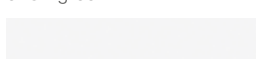
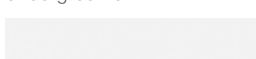

Due to the different panel cross-sections, the choice of the fastening system depends on the individual case. Furthermore, color deviations compared to the standard variants can not be excluded.



SpectraView glazed, silky-matt

				
6201 cream 1 H	6202 cream 2 H	6203 cream 3 H	6204 cream 4 H	6205 cream 5 H
				
6211 yellow 1 H	6212 yellow 2 H	6213 yellow 3 H	6214 yellow 4 H	6215 yellow 5 H
				
6221 apricot 1 H	6222 apricot 2 H	6223 apricot 3 H	6224 apricot 4 H	6225 apricot 5 H
				
6231 salmon-red 1 H	6232 salmon-red 2 H	6233 salmon-red 3 H	6234 salmon-red 4 H	6235 salmon-red 5 H
				
6241 pink 1 H	6242 pink 2 H	6243 pink 3 H	6244 pink 4 H	6245 pink 5 H
				
6251 neutral-grey 1 H	6252 neutral-grey 2 H	6253 neutral-grey 3 H	6254 neutral-grey 4 H	6255 neutral-grey 5 H
				
6261 grey 1 H	6262 grey 2 H	6263 grey 3 H	6264 grey 4 H	6265 grey 5 H
				
6271 blue 1 H	6272 blue 2 H	6273 blue 3 H	6274 blue 4 H	6275 blue 5 H
				
6281 green 1 H	6282 green 2 H	6283 green 3 H	6284 green 4 H	6285 green 5 H
				
	4230 glacier-white, glossy H	4234 chalk-white, matt H	4530 black, glossy H	4534 black, matt H

Contrasting colors glazed, glossy

				
150 lemon-yellow H	151 orange H	152 apple-green H	153 violet H	154 contrasting red H
				
144 intense blue H				

Natura unglazed

				
407 white 407 white H	410 cream 410 cream H	411 ochre 411 ochre H	412 salmon 412 salmon H	396 salmon-red 396 salmon-red H
				
403 red 403 red H	397 brick-red 397 brick-red H	408 red-brown 408 red-brown H	418 brown 418 brown H	414 light-grey 414 light-grey H
				
409 iron-grey 409 iron-grey H	415 N vulcan-grey 415 N vulcan-grey H	419 black 419 black H	416 smoky-blue 416 smoky-blue H	417 patina-green 417 patina-green H

Design unglazed



1403 golden red
1403 golden red H



1410 golden cream
1410 golden cream H



1414 golden grey
1414 golden grey H



1415 golden anthracite
1415 golden anthracite H

Design glazed

Stone NEW



1185 Savona lime H



1152 Quarzit basalt-grey H



1100 Stonewall 1 H



1115 Rockface 1 H



1090 Haze 1 H



1188 Savona beige H



1150 Quarzit white-grey H



1101 Stonewall 2 H



1116 Rockface 2 H



1091 Haze 2 H



1189 Savona brown H



1151 Quarzit sand-beige H



1102 Stonewall 3 H



1117 Rockface 3 H



1093 Haze 3 H



1186 Savona grey H



1103 Stonewall 4 H



1092 Haze 4 H



1187 anthracite H

Stone



1110 Mega 1 H



1140 Construct 1 H



1180 Metal 1 H



1190 Metallic 1

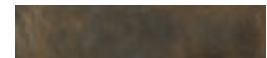

1155 vertical Streetlife rust H
1156 horizontal Streetlife rust H



1111 Mega 2 H



1141 Construct 2 H



1181 Metal 2 H



1191 Metallic 2



1112 Mega 3 H



1182 Metal 3 H



1192 Metallic 3

Cement

Metal

NEW

NEW

Wood

NEW

NEW



1145 Oak cream oak H

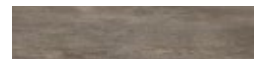

1165 Driftwood grey-brown H



1170 Bosco 1 H



1146 Oak natural oak H



1171 Bosco 2 H



1147 Oak anthracite oak H



1172 Bosco 3 H



In addition to the variants shown, the production of individual articles is also possible. After a short check of the individual case for technical and economical feasibility, we will be pleased to provide you with project-specific information.

H = HT coating

KeraTwin® K20 – Fastening with vertical system rail K20



System description

The KeraTwin® K20 facade panels are simply hung in the vertical system rail with the holding grooves on the reverse side. For mounting the panels, no additional tools are required. The compression spring and removal protection integrated in the system rail prevents clattering and constraining forces in the case of alternating wind loads and also the easy removal of panels. The position of the panels is secured either by means of a joint profile adjusted to the joint width or by means of spacers.

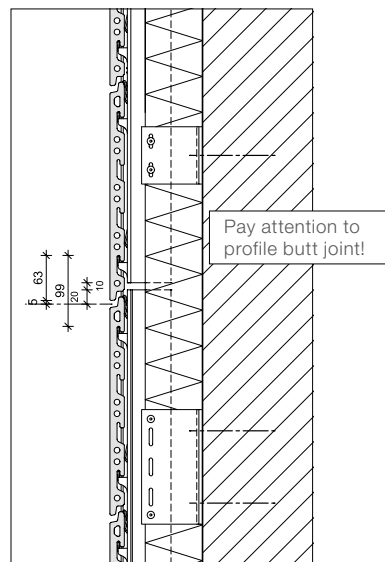

- 1 Facade panel KeraTwin® K20
- 2 Vertical system rail K20, article 620
- 3 A4 stainless steel screw, article 659 (alternatively, fastening with Al blind rivet, article 658, is possible), fixing necessary under each fastening hook!
- 4 Vertical bearing profile (basic substructure) Minimum width 80 mm / recommended width 100 mm
- 5 Wall bracket (basic substructure)

! A profile butt joint of the vertical bearing profiles behind a panel is not allowed! See standard technical detail drawings.

Mounting instructions for KeraTwin® K20 – Fastening by means of vertical system rail K20



Mounting instructions as video film:
www.agrob-buchtal.de

Substructure

The mounting of the substructure must be carried out according to project-specific, static calculation. The general approval Z-33.1-1175 of the construction supervisory authority serves as basis.

- The profiles of the basic substructure have to be mounted perpendicularly and in a flush way. (T-profile width ≥ 80 mm; recommended width ≥ 100 mm)
- The system rails K20 (Art. no. 620, 625, 630) have to be precisely aligned horizontally and fastened at the provided holes by means of screws (Art. no. 659) or rivets (Art. no. 658).
- The distance of the system rails K20 in horizontal direction must correspond to the longitudinal grid of the panels.
- The length of the vertical profiles must be divisible by the height of the panel format and should not exceed the height of a storey of the building.
- A profile butt joint behind a panel is not allowed.
- In case of open vertical joints, one joint spacer per panel (Art. no. 645) is inserted in a centric extrusion hole of the panel.
- In case of closed vertical joints, the joint profile (Art. no. 640 in case of single-span girder; plug-in joint profile, Art. no. 647, in case of single-span girder with jibs) must be used.



Basic substructure



Fasten system rail with Al blind rivet (Art. no. 658) or A4 stainless steel screw (Art. no. 659)



Click in the joint profile (for closed joints)

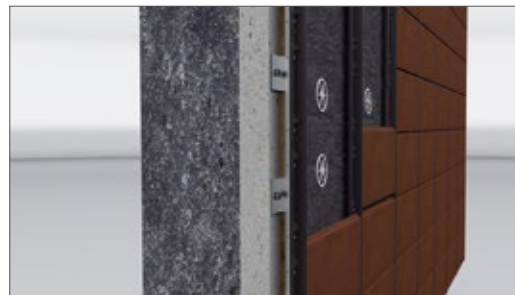

Hang in the KeraTwin® panels

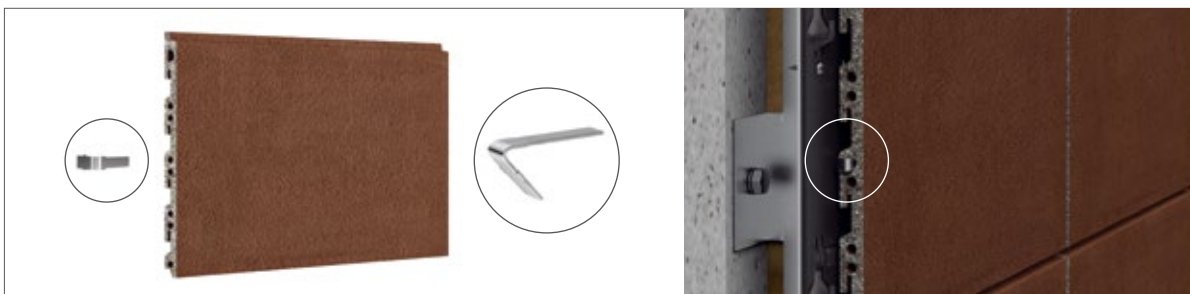

Alternative to the joint profile: spacer, Art. no. 645 (for open joints)

Accessories: KeraTwin® K20 – Fastening with vertical system rail K20

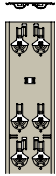

Article 620
System rail, painted*
Material: AlMg3 H22
(EN AW-5754),
painted black,
RAL 7021,
for installation
with joint spacer K20/8



Article 625
System rail, bright*
Material: AlMg3 H22
(EN AW-5754),
unpainted, for installation
with joint profile K20/8

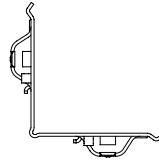

Article 630
System rail, external angle*
Material: AlMg3 H22
(EN AW-5754),
unpainted, for installation
of mitre-cut panels and
external angle profiles

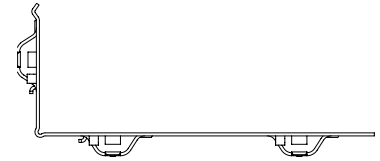

Article 635
Embrasure profile*
Material: AlMg3 H22
(EN AW-5754),
unpainted, dimensions and grid
according to project-specific
requirements

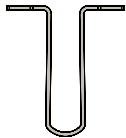

Article 640
Joint profile K20/8
Material: AlMg3 H22
(EN AW-5754),
painted black,
RAL 7021,
RAL-color-painted
on request.

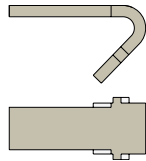

Article 645
Joint spacer K20/8
Weight: 0.5 kg / box
Material: AlMg3 H22
(EN AW-5754)
Box contents: 250 pieces
painted black,
RAL 7021



Article 658
Al blind rivet, bright
Weight: 1.3 kg / box
Nominal dimensions: 4.8 x 10 mm
Box contents: 500 pieces
for system rail installation



Article 659
A4 stainless steel screw, bright
Weight: 2.8 kg / box
Nominal dimensions: 4.8 x 16 mm
Box contents: 1,000 pieces + 1 bit
for system rail installation

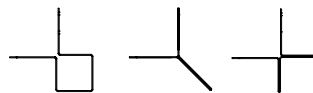

Article 650 / 652 / 654
External angle profile Square /
Sword / Negative
Material: AlMg3 H22
(EN AW-5754),
painted black,
RAL 7021,
RAL-color-painted
on request.

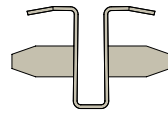

Article 647
Plug-in joint profile K20/8
Material: AlMg3 H22
(EN AW-5754)
painted black,
RAL 7021,
RAL-color-painted on request.
for installation in case of
single-span girder with jibs
Length: 1496 mm

* legally protected

Profile lengths available: Grid of 15 cm, 60 cm: 2992 mm
Grid of 17.5 cm: 2967 mm · Grid of 20 cm, 25 cm, 30 cm, 37.5 cm, 50 cm: 2992 mm
Grid of 22.5 cm, 32.5 cm: 2917 mm · Grid of 27.5 cm: 3017 mm
Grid of 35 cm, 40 cm: 2792 mm · Grid of 55 cm: 3292 mm
Grid of 45 cm: 2692 mm

System rail K20 available for panel grids of 15 cm - 17.5 cm - 20 cm - 22.5 cm -
25 cm - 27.5 cm - 30 cm - 32.5 cm - 35 cm - 37.5 cm - 40 cm - 45 cm -
50 cm - 55 cm - 60 cm. Other grids on request.

Important: The use of silicone caoutchoucs must be absolutely avoided, because silicone fluids segregate and effect sticky surfaces on which dirt adheres. Therefore, only use the system components mentioned (foamed pieces, EDPM rubber profile, neoprene rubber washer) and pointing, bonding and sealing materials recommended by us. We will be pleased to inform you in detail. The usual final cleaning after completion of the construction works is still required. A warranty for the system KeraTwin® K20 in the scope of the general approval no. Z-33.1-1175 of the construction supervisory authority only applies if the system components shown on these pages are used.



Ordre des infirmières et infirmiers du Québec, Canada / Architect: Lemay architecte / Year: 2015 / Photo: Adrien Williams



Mikrovisata, Kaunans, Lithuania, Baltic States / Architect: G. Natkevičius ir partneriai / Year: 2015 / Photo: Leonas Garbačiauska



Underground railway line 4, Rio de Janeiro, Brazil / Year: 2016 / Photo: Lorenzo Rimondi



Sonaville Appartementencomplex, Nijmegen, the Netherlands / Architect: Molenaar en Co Architecten / Year: 2010 / Photo: Marcel van der Burg



Orangerie de Soussie, Morocco / Architect: JLA Studio / Year: 2016 / Photo: Sife Elamine

KeraTwin® K20 – Fastening with vertical T-profile K20

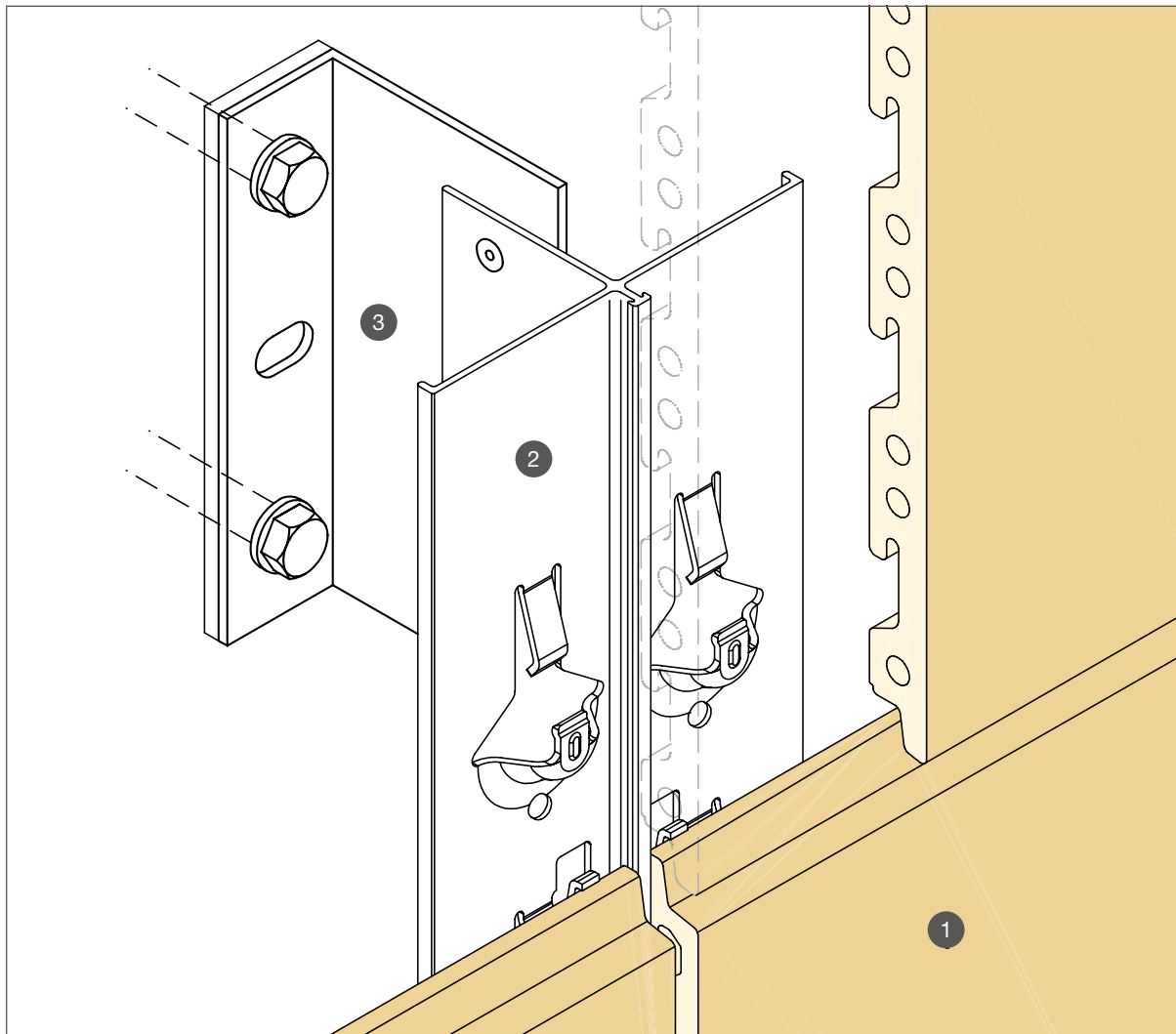

System description

The KeraTwin® K20 facade panels are simply hung in the vertical T-profile K20 with the holding grooves on the reverse side. For mounting the panels, no additional tools are required. The compression spring and removal protection integrated in the T-profile K20 prevents clattering and constraining forces in the case of alternating wind loads and also the easy removal of panels. The position of the panels is secured either by means of profile types adjusted to the joint width or by means of spacers for closed or open vertical joints.

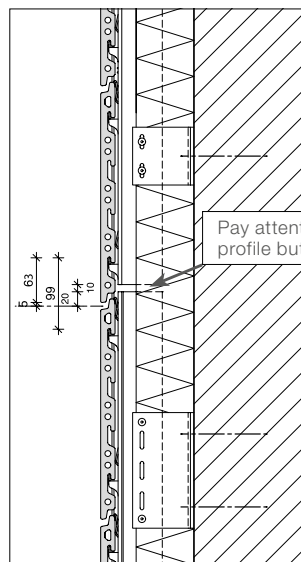

- 1 Facade panel KeraTwin® K20
- 2 Vertical T-profile K20, article 698
- 3 Wall bracket (basic substructure)



A profile butt joint of the vertical bearing profiles behind a panel is not allowed! See standard technical detail drawings.

Mounting instructions for KeraTwin® K20 – Fastening by means of vertical T-profile K20



Mounting instructions as video film:
www.agrob-buchtal.de

Substructure

The mounting of the substructure must be carried out according to project-specific, static calculation. The general approval Z-33.1-1175 of the construction supervisory authority serves as basis.

- Mount the T-profiles K20 (Art. no. 690, 695, 698) perpendicularly and in a flush way.
- Exactly align the T-profiles K20 horizontally.
- Open vertical joints with T-profile K20 (Art. no. 698) or T-profile K20 (Art. no. 695) with spacer (Art. no. 645).
- Fastening with single-span girder: T-profiles K20 (Art. no. 690, 695, 698)
- Fastening with single-span girder with jib on both sides: T-profile K20 (Art. no. 695); for closed vertical joints, use the plug-in joint profile (Art. no. 647).



Basic substructure



Mount the T-profile with approved fastening means



Hang in the KeraTwin® panels



Alternative to T-profile with joint profile: spacer,
Art. no. 645 (for open joints)

Accessories: KeraTwin® K20 – Fastening by means of vertical T-profile K20

* legally protected

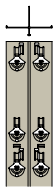

Article 690
T-profile K20 with joint
profile, painted*
Material: EN AW-6060 T6
painted black,
RAL 7021



Article 698
T-profile K20 with
recessed joint profile,
painted*
Material: EN AW-6060 T6
painted black,
RAL 7021



Article 695
T-profile K20 without joint
profile, painted*
Material: EN AW-6060 T6
painted black,
RAL 7021,
for installation
with joint spacer K20/8

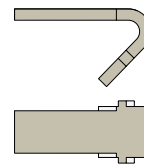

Article 645
Joint spacer K20/8
Weight: 0.5 kg / box
Material: AlMg3 H22
(EN AW-5754)
Box contents: 250 pieces
painted black,
RAL 7021

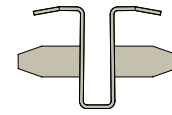

Article 647
Plug-in joint profile K20/8
Material: AlMg3 H22 (EN
AW-5754)
painted black, RAL 7021,
RAL-color-painted on request
for installation in case of
single-span girder with jibs
Length: 1496 mm

Profile lengths available: Grid of 15 cm, 60 cm: 2992 mm · Grid of 17.5 cm: 2967 mm
Grid of 20 cm, 25 cm, 30 cm, 37.5 cm, 50 cm: 2992 mm · Grid of 22.5 cm, 32.5 cm: 2917 mm
Grid of 27.5 cm: 3017 mm · Grid of 35 cm, 40 cm: 2792 mm · Grid of 55 cm: 3292 mm
Grid of 45 cm: 2692 mm

T-profile K20 available for panel grids of 15 cm - 17.5 cm - 20 cm -
22.5 cm - 25 cm - 27.5 cm - 30 cm - 32.5 cm - 35 cm - 37.5 cm -
40 cm - 45 cm - 50 cm - 55 cm - 60 cm. Other grids on request.

Important: The use of silicone caoutchoucs must be absolutely avoided, because silicone fluids segregate and effect sticky surfaces on which dirt adheres. Therefore, only use the system components mentioned (foamed pieces, EDPM rubber profile, neoprene rubber washer) and pointing, bonding and sealing materials recommended by us. We will be pleased to inform you in detail. The usual final cleaning after completion of the construction works is still required. A warranty for the system KeraTwin® K20 in the scope of the general approval no. Z-33.1-1175 of the construction supervisory authority only applies if the system components shown on these pages are used.

KeraTwin® K20 – Fastening with vertical Omega profile K20



System description

The Omega profile stands out due to its simple and efficient installation on difficult bases such as e.g. walls with post and beam construction. Horizontal bearing profiles are fixed at the posts. The vertical Omega profiles can then be arranged independent of the distance between the posts, and the panel lengths can be freely planned. The complex system structure with dowel, wall bracket and vertical bearing profile is not required. The subsequent laying of the ceramics is carried out as in the case of the system rail K20. The KeraTwin® K20 facade panels are simply hung in the vertical Omega profile with the holding grooves on the reverse side. No additional tools are required for mounting the panels. The compression spring and removal protection integrated in the Omega profile prevents clattering and constraining forces in the case of alternating wind loads and also the easy removal of panels. The position of the panels is secured either by means of a joint profile adjusted to the joint width or by means of spacers.

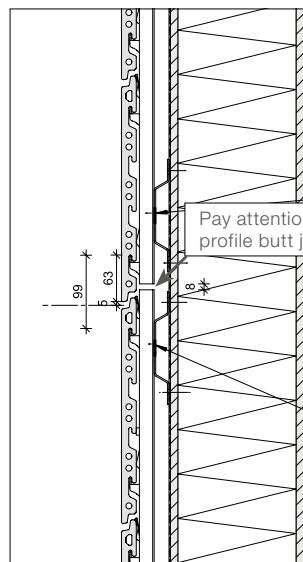

- 1 Facade panel KeraTwin® K20
- 2 Vertical Omega profile K20, article 624
- 3 A4 stainless steel screw, article 659 (alternatively, fastening with Al blind rivet, article 658, is possible)
- 4 Horizontal bearing profile (basic substructure)

! A profile butt joint of the vertical bearing profiles behind a panel is not allowed! See standard technical detail drawings.

Mounting instructions for KeraTwin® K20 – Fastening by means of vertical Omega profile K20



Mounting instructions as video film:
www.agrob-buchtal.de

Substructure

The mounting of the substructure must be carried out according to project-specific, static calculation. The general approval Z-33.1-1175 of the construction supervisory authority serves as basis.

- The profiles of the basic substructure have to be mounted perpendicularly and in a flush way (top-hat or alternatively Z-profile).
- The Omega profiles K20 (Art. no. 624, 627, 633) have to be precisely aligned horizontally and be fixed through the long holes provided on the edge by means of screws (Art. no. 659) or rivets (Art. no. 658). (Pay attention to fixed and sliding point execution!)
- The distance of the rails in horizontal direction must correspond to the longitudinal grid of the panels.
- A profile butt joint behind a panel is not allowed.
- In case of open vertical joints, one joint spacer per panel (Art. no. 645) is inserted in a centric extrusion hole of the panel.
- In case of closed vertical joints, the joint profile (Art. no. 640 in case of single-span girder; plug-in joint profile, Art. no. 647, in case of single-span girder with jibs) must be used.



Basic substructure



Fasten Omega profile with Al blind rivet (Art. no. 658) or A4 stainless steel screw (Art. no. 659) (Pay attention to fixed and sliding point)



Click in the joint profile (for closed joints)



Hang in the KeraTwin® panels

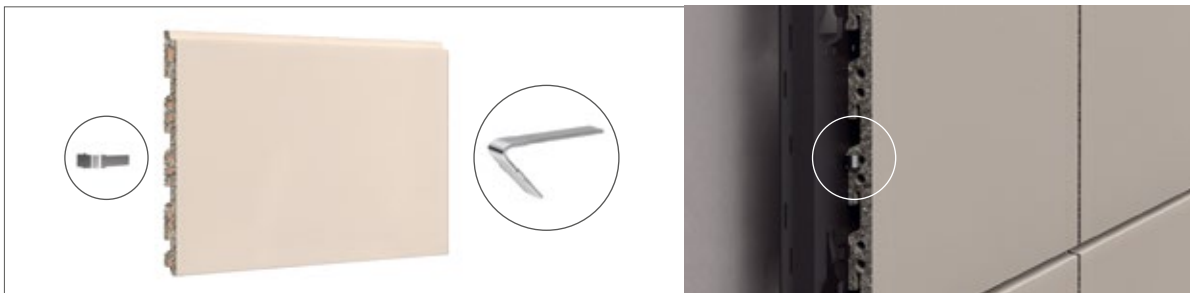

Alternative to the joint profile: spacer, Art. no. 645 (for open joints)

Accessories: KeraTwin® K20 – Fastening by means of vertical Omega profile K20

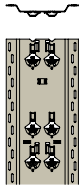

Article 624
Omega profile, painted*
Material: AlMg3 H22
(EN AW-5754),
painted black, RAL 7021,
for installation
with joint spacer K20/8

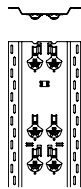

Article 627
Omega profile, bright*
Material: AlMg3 H22
(EN AW-5754),
unpainted, for installation
with joint profile K20/8



Article 633
Omega profile, external angle*
Material: AlMg3 H22
(EN AW-5754),
unpainted, for the installation of
mitre-cut panels and external
angle profiles



Article 658
Al blind rivet, bright
Weight: 1.3 kg / box
Nominal dimensions: 4.8 x 10 mm
Box contents: 500 pieces
for Omega profile installation



Article 659
A4 stainless steel screw, bright
Weight: 2.8 kg / box
Nominal dimensions: 4.8 x 16 mm
Box contents: 1,000 pieces + 1 bit
for Omega profile installation

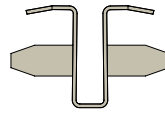

Article 647
Plug-in joint profile K20/8
Material: AlMg3 H22
(EN AW-5754)
painted black, RAL 7021,
RAL-color-painted on request
for installation in case of
single-span girder with jib
Length: 1496 mm

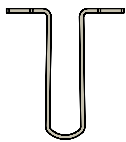

Article 640
Joint profile K20/8
Material: AlMg3 H22
(EN AW-5754),
painted black, RAL 7021,
RAL-color-painted on request

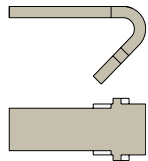

Article 645
Joint spacer K20/8
Weight: 0.5 kg / box
Material: AlMg3 H22
(EN AW-5754)
Box contents: 250 pieces
painted black, RAL 7021

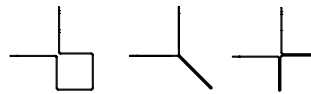

Article 650 / 652 / 654
External angle profile
Square / Sword / Negative
Material: AlMg3 H22
(EN AW-5754),
painted black, RAL 7021,
RAL-color-painted on request

* legally protected

Profile lengths available: Grid of 15 cm, 60 cm: 2992 mm
Grid of 17.5 cm: 2967 mm · Grid of 20 cm, 25 cm, 30 cm, 37.5 cm, 50 cm: 2992 mm
Grid of 22.5 cm, 32.5 cm: 2917 mm · Grid of 27.5 cm: 3017 mm
Grid of 35 cm, 40 cm: 2792 mm · Grid of 55 cm: 3292 mm
Grid of 45 cm: 2692 mm

Omega profile K20 available for panel grids of 15 cm - 17.5 cm - 20 cm -
22.5 cm - 25 cm - 27.5 cm - 30 cm - 32.5 cm - 35 cm - 37.5 cm - 40 cm -
45 cm - 50 cm - 55 cm - 60 cm. Other grids on request.

Important: The use of silicone caoutchoucs must be absolutely avoided, because silicone fluids segregate and effect sticky surfaces on which dirt adheres. Therefore, only use the system components mentioned (foamed pieces, EDPM rubber profile, neoprene rubber washer) and pointing, bonding and sealing materials recommended by us. We will be pleased to inform you in detail. The usual final cleaning after completion of the construction works is still required. A warranty for the system KeraTwin® K20 in the scope of the general approval no. Z-33.1-1175 of the construction supervisory authority only applies if the system components shown on these pages are used.



Private villa, Romania / Architect: Victor Gota / Year: 2016



Raiffeisen Forum, Mödling, Austria / Architect: arge x42 / Year: 2014 / Photo: Rich Hiebl



Town Center Costa del Este Panama City / Architect: Alexandra Brauer / Year: 2017 / Photo: Lorenzo Rimondi



University, Bologna, Italy / Architect: Raffaele PANELLA / Year: 2015 / Photo: Lorenzo Rimondi



SNAC, Southampton, Great Britain / Architect: CZWB Architects / Year: 2015 / Photo: Norbert Lindner

KeraTwin® K20 – Fastening with OmegaV profile for laying in bonds

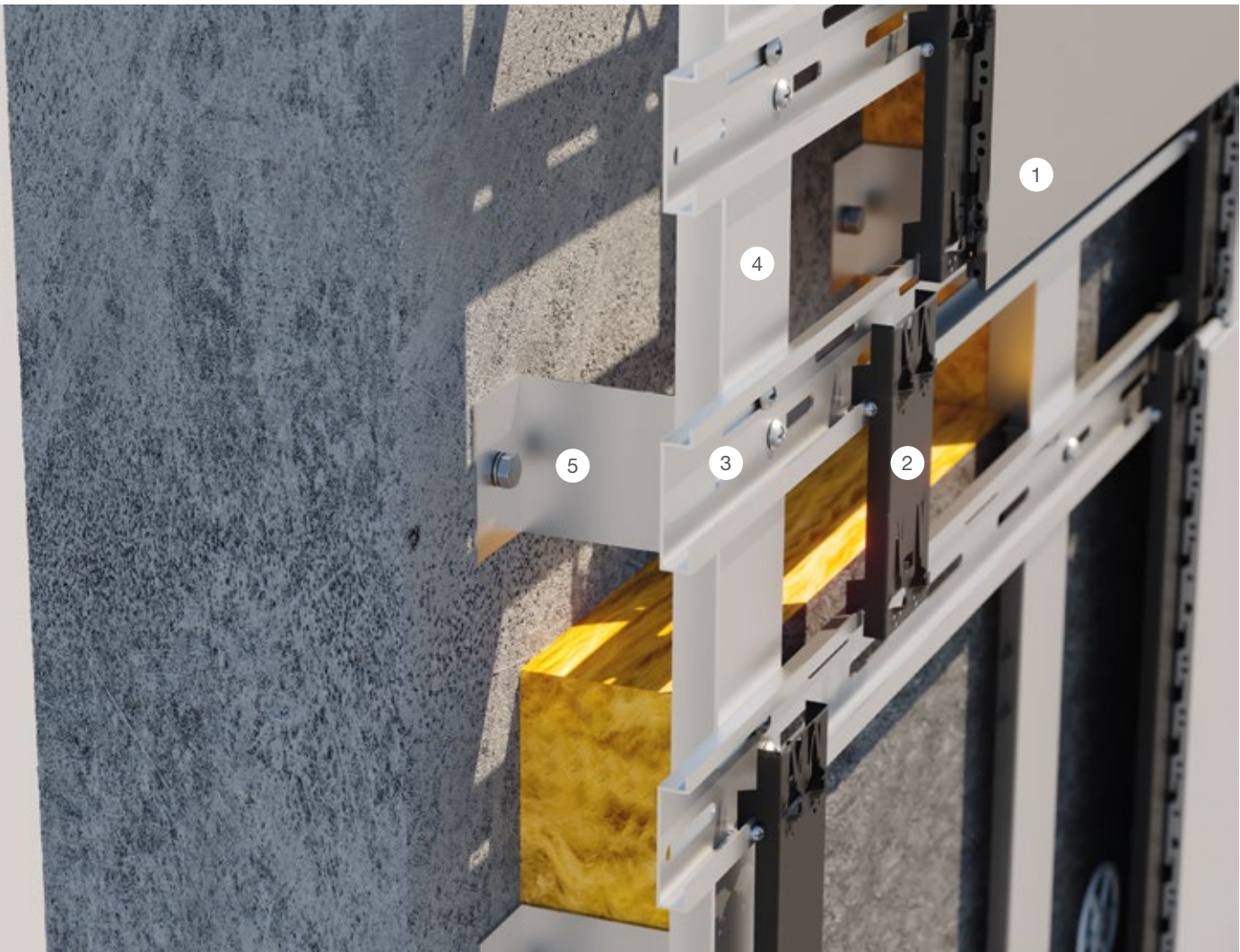

System description

The OmegaV profile was developed to enable installation of KeraTwin® K20 panels in various bonds while availing of all of the advantages offered by the K20 system. The horizontal bearing profiles are fastened to a basic construction at the desired height grid. Then the OmegaV profiles can be hung from the horizontal bearing profiles and with the requisite spacing (length grid) before being secured to the two top suspension brackets using A4 stainless steel screws. The KeraTwin® K20 façade panels are simply hung in the preassembled OmegaV profiles using the holding grooves on the reverse side. No additional tools are required for mounting the panels. The compression spring integrated in the OmegaV profile prevents clattering and constraining forces in the case of alternating wind loads as well as the easy removal of panels. The position of the panels is secured either by means of a joint profile adjusted to the joint width or using spacers.

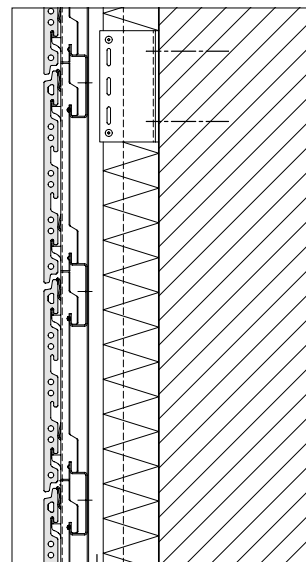

- 1 KeraTwin® K20 facade panel
- 2 OmegaV profile, Article 700
- 3 Horizontal supporting profile, Article 597-01
- 4 Vertical bearing profile (basic substructure)
- 5 Wall bracket (basic substructure)

System illustration

Mounting instructions for KeraTwin® K20 – with OmegaV for laying in bonds



Mounting instructions as video film:
www.agrob-buchtal.de

Substructure

The mounting of the substructure must be carried out according to project-specific, static calculation. The general approval Z-33.1-1175 of the construction supervisory authority serves as basis.

- The profiles of the basic substructure have to be mounted perpendicularly and in a flush way.
- Fix the horizontal supporting profiles (Art. no. 597) at the pre-installed vertical substructure by means of the supplied fastening materials.
- Hang in the OmegaV profiles exactly at horizontal grid distance.
- The distance of the profiles in horizontal direction must correspond to the longitudinal grid of the panels.
- The position of the OmegaV profiles is secured at the suspension brackets on the left and the right.

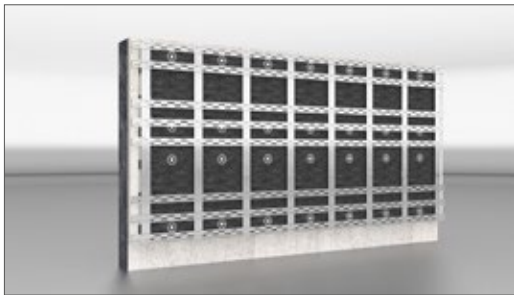

Basic substructure with horizontal supporting profiles

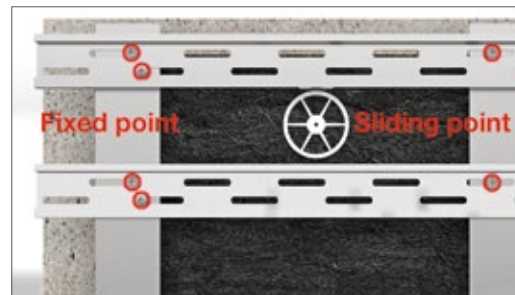

Fixed and sliding point execution

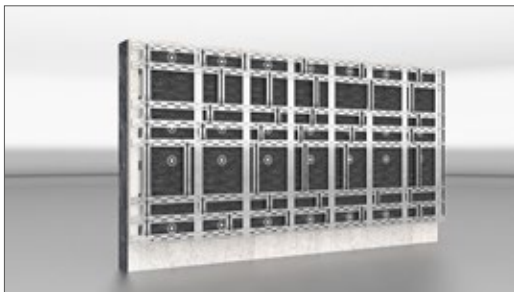

OmegaV profiles



Fixing of OmegaV profiles

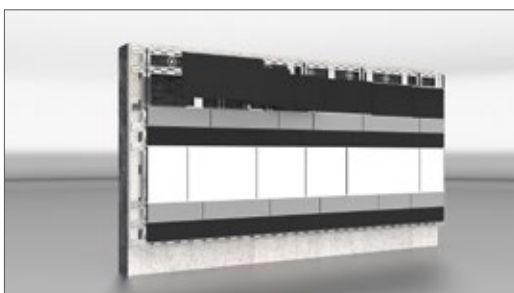

Panel mounting

Accessories: KeraTwin® K20 – OmegaV fastening on horizontal supporting profile

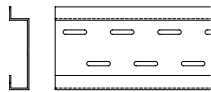

Article 597-01
Horizontal supporting profile,
perforated
Standard length: 2995 mm
Nominal dimensions: 05/90 x 25 mm
Material: EN AW 6063 T66
unpainted

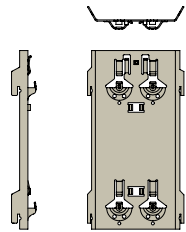

Article 700
OmegaV, painted*,
RAL 7021
Material: AlMg3 H22
(EN AW-5754)
painted black,
for installation
with joint spacer K20/8

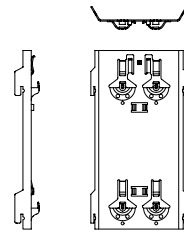

Article 701
OmegaV, bright*
Material: AlMg3 H22
(EN AW-5754)
unpainted, for installation
with joint profile Single K20/8

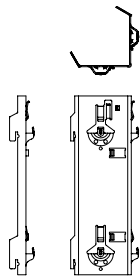

Article 705
OmegaV, external angle, bright*
Material: AlMg3 H22
(EN AW-5754)
unpainted, for the installation
of mitre-cut panels and external
angle profiles

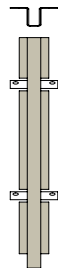

Article 707
Joint profile Singel K20/8
Material: AlMg3 H22
(EN AW-5754)
painted black, RAL 7021
RAL-color-painted on request

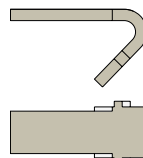

Article 645
Joint spacer K20/8
Weight: 0.5 kg/box
Material: AlMg3 H22
(EN AW-5754)
Box contents: 250 pieces
painted black,
RAL 7021



Article 658
Al blind rivet, bright
Weight: 1.3 kg / box
Nominal dimensions: 4.8 x 10 mm
Box contents: 500 pieces
for Omega profile installation



Article 659-01
A4 stainless steel screw, bright
Weight: 1.4 kg/box
Nominal dimensions: 4.8 x 16 mm
Box contents: 500 pieces + 1 bit
for OmegaV fastening

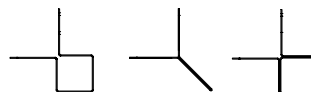

Article 650 / 652 / 654
External angle profile
Square / Sword / Negative
Material: AlMg3 H22
(EN AW-5754),
painted black, RAL 7021
RAL-color-painted on request

* legally protected

OmegaV profiles and joint profiles Singel available for all standard grids (see page 51). Other grids available on request.

Important: The use of silicone caoutchoucs must be absolutely avoided, because silicone fluids segregate and effect sticky surfaces on which dirt adheres. Therefore, only use the system components mentioned (foamed pieces, EDPM rubber profile, neoprene rubber washer) and pointing, bonding and sealing materials recommended by us. We will be pleased to inform you in detail. The usual final cleaning after completion of the construction works is still required. A warranty for the system KeraTwin® K20 in the scope of the general approval no. Z-33.1-1175 of the construction supervisory authority only applies if the system components shown on these pages are used.



Naabtal-Realschule (secondary school), Nabburg, Germany / Architect: Architekturbüro Schönberger / Year: 2016 / Photo: Atelier Bürger

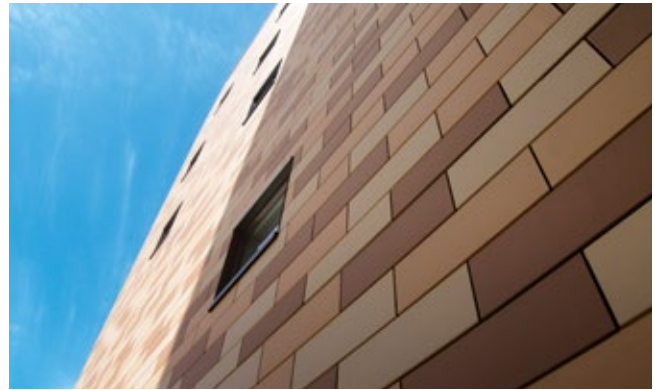

Queen Alexandra Hospital, Portsmouth, Great Britain / Architect: BDP, Whiceloe Macfarlane / Year: 2009 / Photo: David Salmon

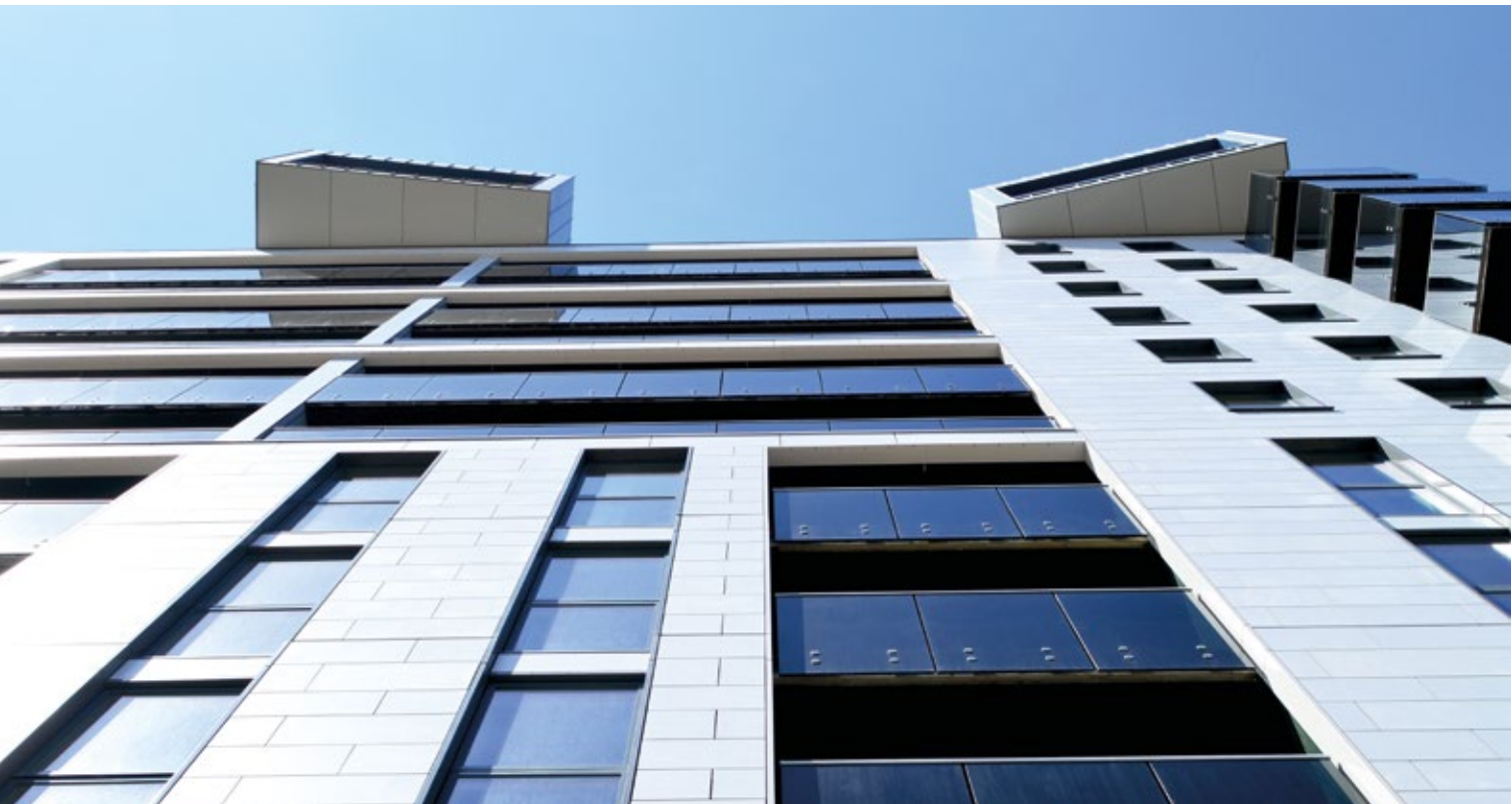

Thurston Road, London, Great Britain / Architect: ECE Architecture / Year: 2015 / Photo: Alice Jenner



Brofestebygget, Alesund, Norway / Architect: Slyngstad Aamlid Arkitekter / Year: 2015



Hall of residence Emmanuel College, Cambridge, Great Britain / Architect: Bidwells / Year: 2016 / Photo: David Salmon

KeraTwin® K20 – Fastening OmegaS with Omega profile and supporting profile



System description

Omega profile and OmegaS supporting profile permit vertical installation of the KeraTwin® facade panels. Secured to the vertical supporting structure, the OmegaS profiles arranged horizontally carry off wind loads and the dead weight of the panels is carried off by the supporting profile mounted in the height grid. The KeraTwin® K20 facade panels are simply hung horizontally in the Omega profiles using the holding grooves on the reverse side. No additional tools are required for mounting the panels. The compression spring integrated in the Omega profile prevents clattering and constraining forces in the case of alternating wind loads. Each KeraTwin® panel is secured using two securing angles to prevent it from slipping out. The horizontal joints can be open or closed with joint profiles.

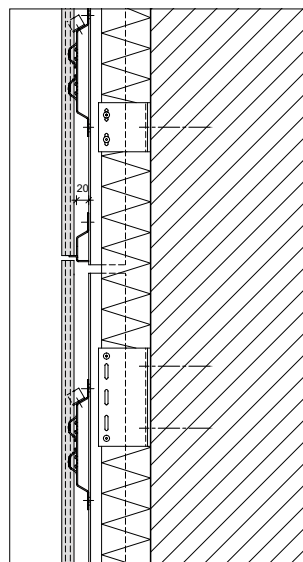

- 1 KeraTwin® K20 facade panel
- 2 Omega profile K20, Article 627
- 3 Supporting profile OmegaS, Article 710
- 4 Securing bracket, Article 711
- 5 Vertical bearing profile (basic substructure)
- 6 Wall bracket (basic substructure)

■ A profile butt joint of the vertical bearing profiles behind a panel is not allowed! See standard technical detail drawings.

Mounting instructions for KeraTwin® K20 – OmegaS with Omega and supporting profile



Mounting instructions as video film:
www.agrob-buchtal.de

Substructure

The mounting of the substructure must be carried out according to project-specific, static calculation. The general approval Z-33.1-1175 of the construction supervisory authority serves as basis.

- The profiles of the basic substructure have to be mounted perpendicularly and in a flush way.
- Fix the horizontal K20 Omega profiles (Art. no. 627) at the pre-installed vertical substructure by means of the supplied fastening materials. The vertical distance depends on the panel length - single-span girder (= 1/2 of panel length), with jibs on both sides (= 1/4 of panel length).
- Mount the supporting profiles according to the height grid (panel length + 8 mm).
- Fully insert the KeraTwin® panels in the construction.
- Position the securing brackets at both Omega profiles and fix them.



Basic substructure with K20 Omega profiles

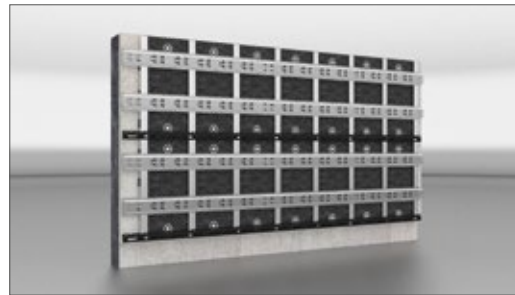

OmegaS with Omega and supporting profiles

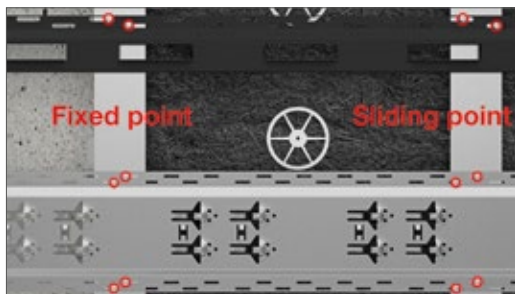

Fixed and sliding point execution



Panel mounting

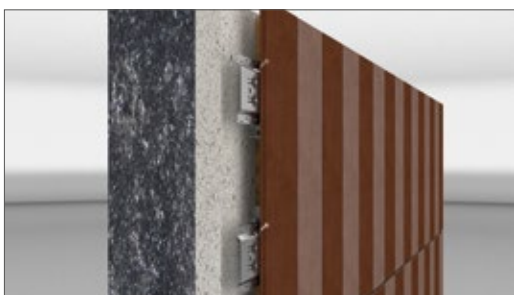

Securing of the position of the panels at the K20 Omega profiles (with securing brackets)

Accessories: KeraTwin® K20 – Fastening with OmegaS supporting profile for vertical mounting

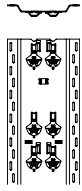

Article 627
Omega profile, bright*
Material: AlMg3 H22
(EN AW-5754),
unpainted

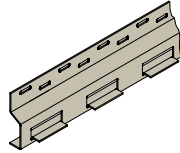

Artikel 710
OmegaS supporting profile
painted
Material: AlMg3 H22
(EN AW-5754)
painted black
RAL 7021

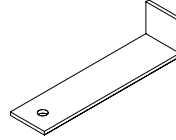

Artikel 711
Position securing bracket, bright
Material: AlMg3 H22
(EN AW-5754)
unpainted
Box contents: 50 pieces



Article 658
Al blind rivet, bright
Weight: 1.3 kg / box
Nominal dimensions: 4.8 x 10 mm
Box contents: 500 pieces
for Omega profile installation



Artikel 659-01
A4 stainless steel screw, bright
Weight: 1.4 kg/box
Nominal dimensions: 4.8 x 16 mm
Box contents: 500 pieces + 1 bit
or the fastening of Omega profile,
OmegaS and position securing
bracket

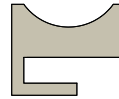

Article 688
Joint profile
Material: EN AW 6063 T66
painted black, RAL 7021,
RAL-color-painted
on request
Length: 1496 mm

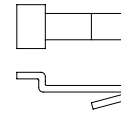

Article 689
Holding clip for joint profile
Material: AlMg1
(EN AW 5005 A)
unpainted
Box contents: 100 pieces

* legally protected

Omega profiles and OmegaS supporting profile available for all standard grids (see page 51). Other grids available on request.

Important: The use of silicone caoutchoucs must be absolutely avoided, because silicone fluids segregate and effect sticky surfaces on which dirt adheres. Therefore, only use the system components mentioned (foamed pieces, EDPM rubber profile, neoprene rubber washer) and pointing, bonding and sealing materials recommended by us. We will be pleased to inform you in detail. The usual final cleaning after completion of the construction works is still required. A warranty for the system KeraTwin® K20 in the scope of the general approval no. Z-33.1-1175 of the construction supervisory authority only applies if the system components shown on these pages are used.



Höxter Markt, Höxter, Germany / Architect: msp architekten GmbH / Year: 2015 / Photo: Mark Wohlrab



Clarion Hotel, Helsinki, Finland / Architect: Sarc Architects / Year: 2016



Children's Hospital, Helsinki, Finland / Architect: Sarc Architects / Year: 2017



Hotel Mercure, Madrid, Spain / Architect: BAT Arquitectos / Year: 2017



Pauley Pavilion UCLA University of California, Los Angeles, USA / Architect: NBBJ, Los Angeles, USA / Year: 2012 / Photo: RMA Photography Inc.

KeraTwin® K20 – Fastening with clamp system K20

Horizontal installation



Vertical installation

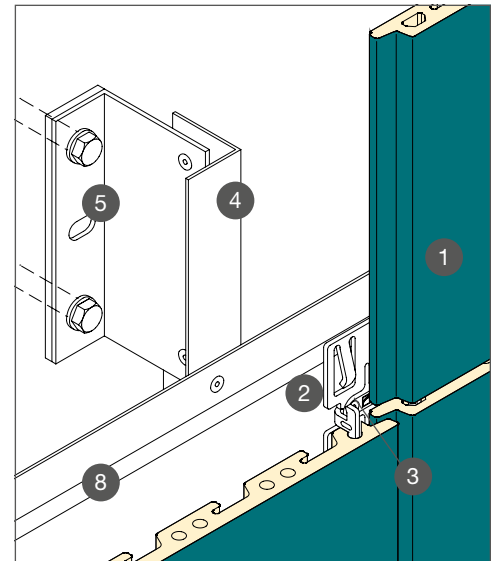

System description

The KeraTwin® K20 facade panels with a maximum panel length of 135 x 50 cm are fixed by means of the clamps K20, which laterally engage with the channels of the facade panel. The compression spring integrated in the clamps prevents clattering and constraining forces in the case of alternating wind loads.

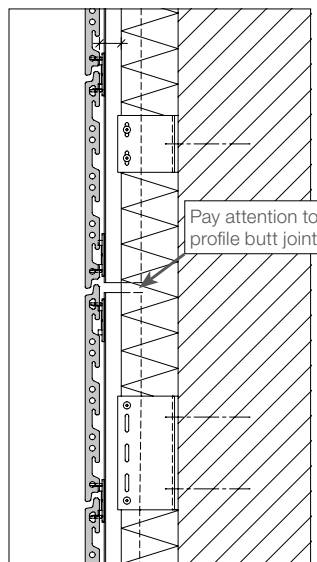

- 1 Facade panel KeraTwin® K20, max. panel length: 135 x 50 cm
- 2 Twin-clamp K20, article 680
- 3 Stainless steel blind rivet, article 675
- 4 Vertical bearing profile (basic substructure)
- 5 Wall bracket (basic substructure)
- 6 Joint tape, black, article 506
- 7 Edge-clamp K20, article 681
- 8 Horizontal bearing profile (basic substructure)

! A profile butt joint of the vertical bearing profiles behind a panel is not allowed! See standard technical detail drawings.

Mounting instructions for KeraTwin® K20 – Fastening with clamp system K20



Mounting instructions as video film:
www.agrob-buchtal.de

Substructure

The mounting of the substructure must be carried out according to project-specific, static calculation. The general approval Z-33.1-1175 of the construction supervisory authority serves as basis.

- The profiles of the basic substructure have to be mounted perpendicularly and in a flush way.
- The distance of the bearing profiles (profile width ≥ 60 mm) in horizontal direction must correspond to the longitudinal grid of the panels.
- The length of the vertical profiles must be divisible by the height of the panel format and should not exceed the height of a storey of the building.
- A profile butt joint behind a panel is not allowed.
- In the vertical joints, the black joint tape (Art. no. 506) can be applied.
- The clamps (Art. no. 680, 681, 682, 683, 684) must be fastened with at least 2 rivets (Art. no. 675).
- For the processing of the rivets (Art. no. 675), an extended rivetting tool (25 mm) is required.
- In the area of the clamp fastening, the joints can be closed with the joint profile (Art. no. 688) and one holding clip for joint profile (Art. no. 689) per panel.



Basic substructure



Apply joint tape on vertical bearing profiles



Fasten edge-clamps with stainless steel blind rivet (Art. no. 675)



Mount the KeraTwin® panels in vertical rows

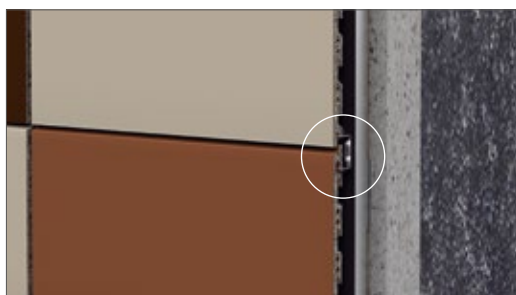

Termination with edge-clamps

Accessories: KeraTwin® K20 – Fastening by means of clamp system K20

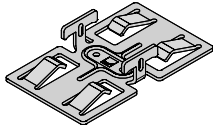

Article 680
Twin-clamp K20*
Weight: 45 kg / 1,000 pieces
Perforation: 2 x 3.3 mm Ø
Material: AlMg3 H22
(EN AW-5754),
painted black,
RAL 7021

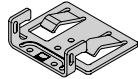

Article 681
Edge-clamp K20*
Weight: 24 kg / 1,000 pieces
Perforation: 4 x 3.3 mm Ø
Material: AlMg3 H22
(EN AW-5754),
painted black,
RAL 7021

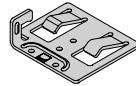

Article 682
Edge-clamp K20, left
Weight: 24 kg / 1,000 pieces
Perforation: 4 x 3.3 mm Ø
Material: AlMg3 H22
(EN AW-5754),
painted black,
RAL 7021

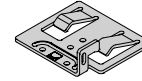

Article 683
Edge-clamp K20, right
Weight: 24 kg / 1,000 pieces
Perforation: 4 x 3.3 mm Ø
Material: AlMg3 H22
(EN AW-5754),
painted black,
RAL 7021

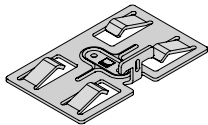

Article 684
Single-clamp K20
Weight: 45 kg / 1,000 pieces
Perforation: 2 x 3.3 mm Ø
Material: AlMg3 H22
(EN AW-5754),
painted black,
RAL 7021

Clamp delivery:
– Twin- and single-clamps: 7 pieces/string
– Edge-clamps: 13 pieces/string



Article 675
Stainless steel blind rivet, black
Weight: 1.05 kg / box
Nominal dimensions: 3.2 x 9.5 mm
Box contents: 500 pieces
extended mandrel (58 mm)

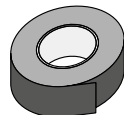

Article 506
Joint tape, black
Weight: 0.5 kg / roll
Nominal dimensions:
40 mm wide, 50 m
self-adhesive, weather-resistant



Article 688
Joint profile
Material: EN AW 6063 T66
painted black, RAL 7021
RAL-color-painted
on request
Length: 1496 mm

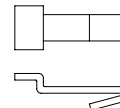

Article 689
Holding clip for joint profile
Material: AlMg1
(EN AW 5005 A)
unpainted
Box contents: 100 pieces

* legally protected

Important: The use of silicone caoutchoucs must be absolutely avoided, because silicone fluids segregate and effect sticky surfaces on which dirt adheres. Therefore, only use the system components mentioned (foamed pieces, EDPM rubber profile, neoprene rubber washer) and pointing, bonding and sealing materials recommended by us. We will be pleased to inform you in detail. The usual final cleaning after completion of the construction works is still required. A warranty for the system KeraTwin® K20 in the scope of the general approval no. Z-33.1-1175 of the construction supervisory authority only applies if the system components shown on these pages are used.

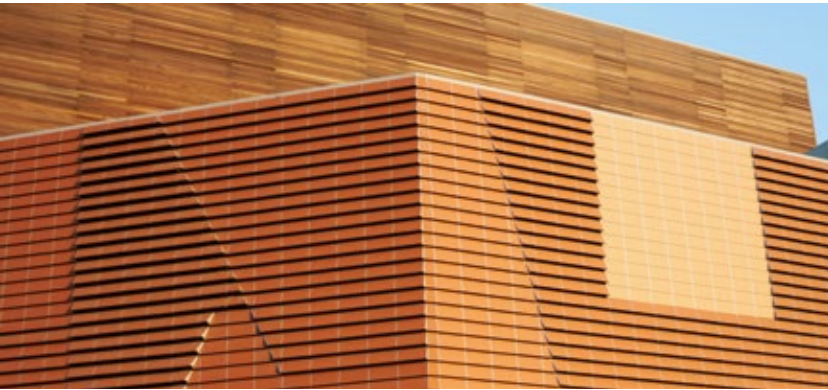

Kongju University, Korea / Year: 2006



Old people's residential home "Postplatz", Kempten, Switzerland / Architect: Sattler Architekten AG / Year: 2014 / Photo: Adriano Faragulo



Office building, Leinfelden-Echterdingen, Germany / Architect: pbs architekten Gerlach Krings Böhning Planungsgesellschaft mbH / Year: 2016 / Photo: Claus Graubner, Frankfurt, Germany



Bowhuis Zoetermeer, Netherlands / Architect: Klunder Architecten / Year: 2006 / Photo: Rob Hoekstra



Ufa, Russia / Architect: Bashkirgrazhdanprojekt, Pavel Mazin / Year: 2015 / Products: KeraTwin®

Detail solutions for KeraTwin®

For ensuring the visual and technical perfection of corners and borders as well, AGROB BUCHTAL has developed standard technical details, which can be adapted to the project-specific requirements as needed – also as special production.

This includes, for example, terminations at windows, doors and the corresponding embrasures, both horizontal and vertical. In addition, mitre-cut panels for corner solutions and practical corner profiles (rectangular or rounded) facilitate the convincing design of problematic facade details.

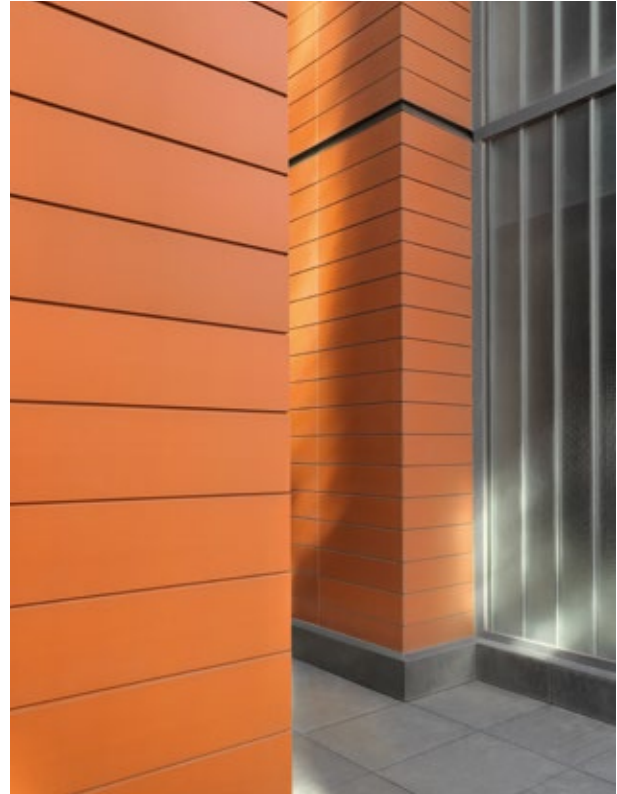

Beijing Airport Industrial Park / Peking, China /
Architect: Perkins + Will

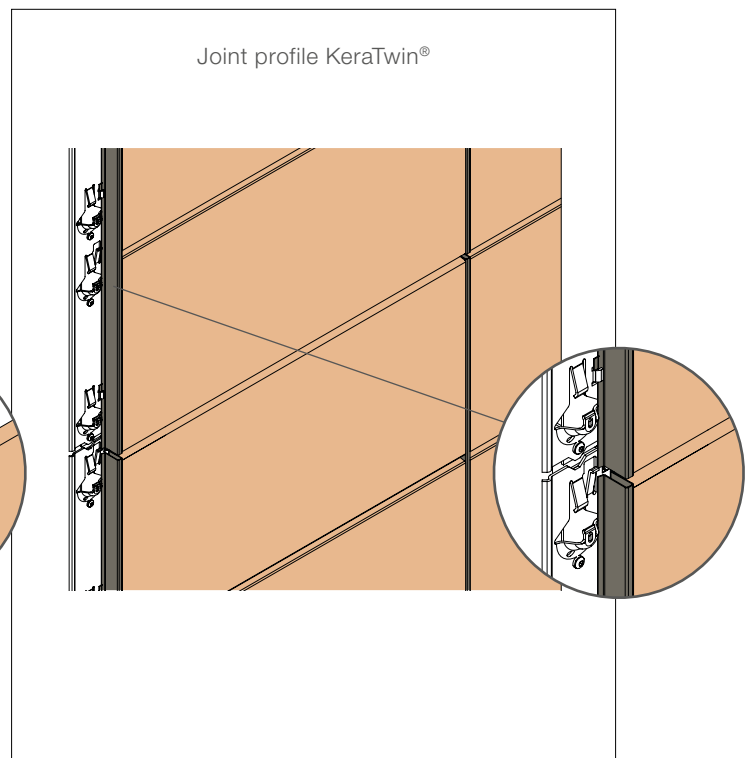
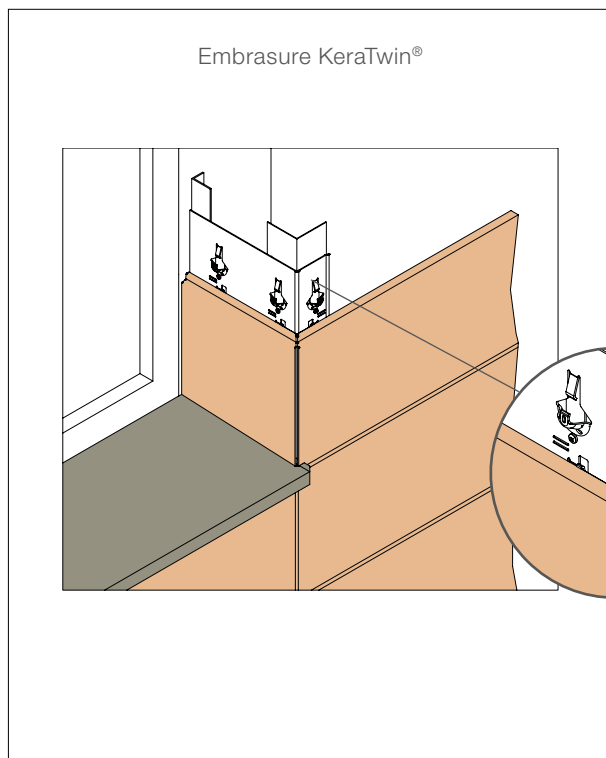

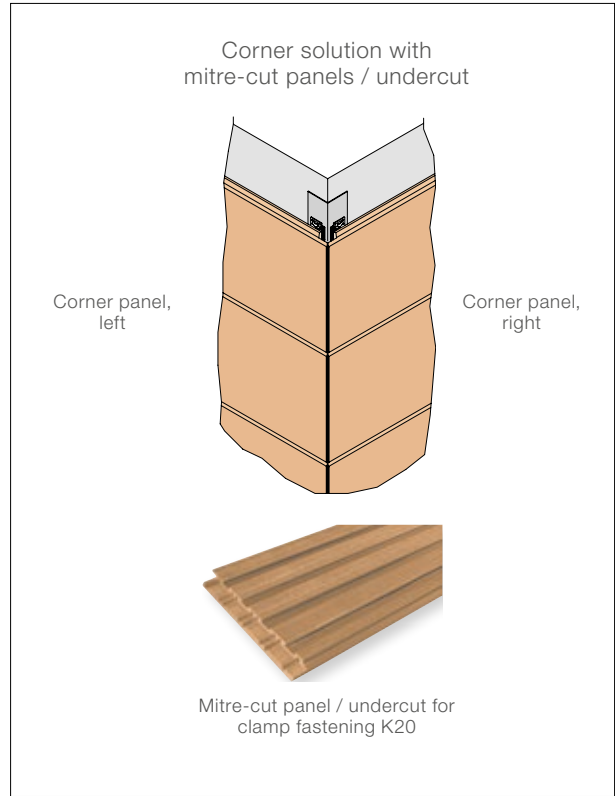
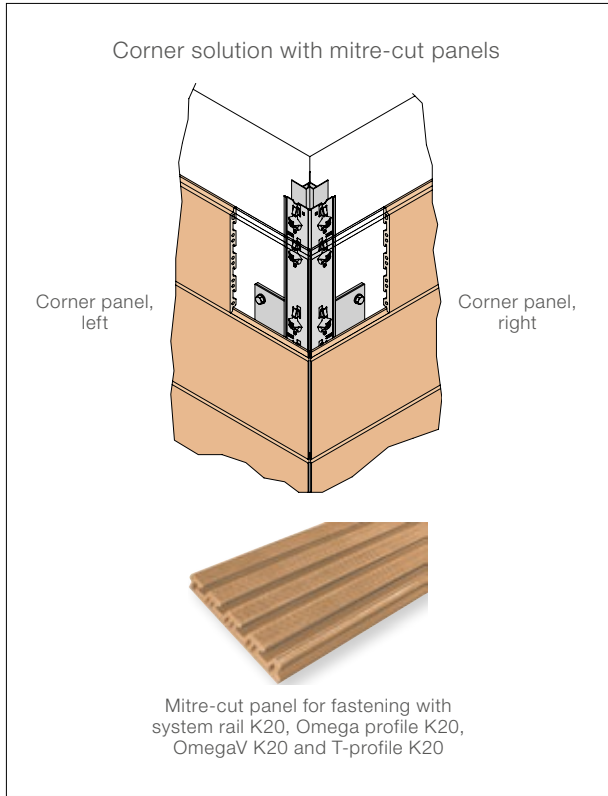

KeraTwin®

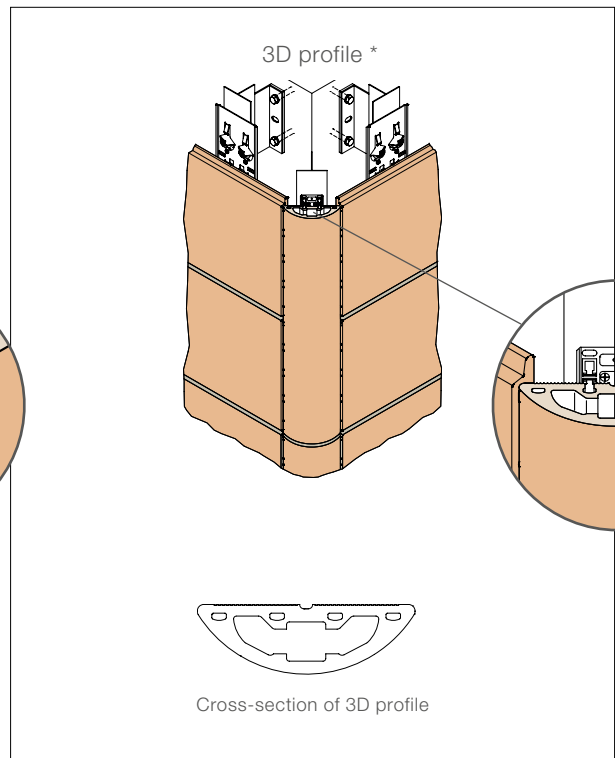
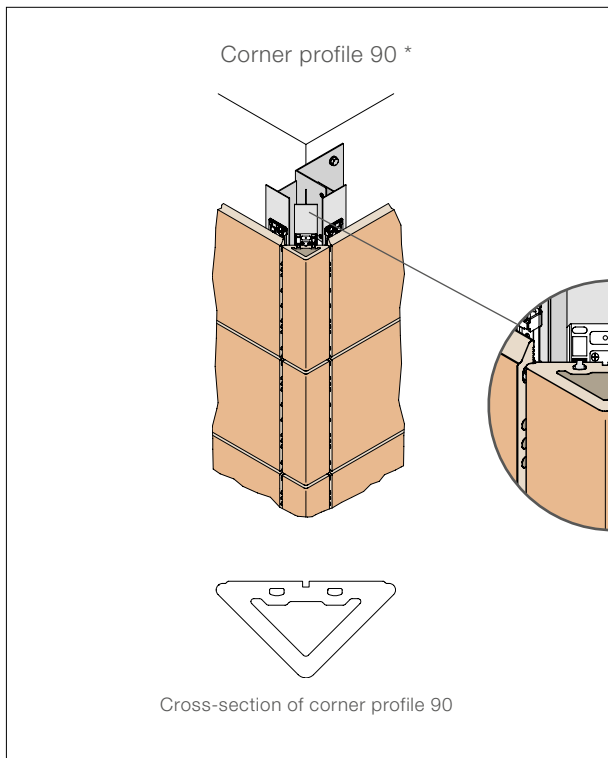

* product-specific details, project-related on request

KERASHAPE®

CERAMIC IN PROFILE

With its extensive bandwidth, the “KeraShape®” is primarily aligned towards setting highlights and supporting architects in realising individual concepts. Apart from their function as elements of architectural design, these moulded parts also serve entirely practical purposes as visual and sun protection.

The standard range comprises rectangular tubes with cross-sections of 50 x 60 mm and 60 x 60 mm in lengths of up to 1,800 mm, with lengths of up to 1,500 mm for the 50 x 100 mm variants. These are complemented by rounded lamellar elements in 140 x 60 mm with a maximum length of 1,200 mm. Using special fastening sets, the individual elements can be merged to form compact units or extended practically infinitely.

Even these standard items – which are perfectly co-ordinated to the other facade systems offered by AGROB BUCHTAL – permit numerous design variants. Furthermore, individual special shapes and sizes are possible depending on the respective building. After a brief examination of the individual case, experts at AGROB BUCHTAL are delighted to provide a technical and economic feasibility analysis.

This also applies to individual fastening concepts deviating from standard fastening variants. As the moulded parts – glazed or unglazed – are supplied in practically any color nuance also available for facade panels, there is nothing to stand in the way of tone-in-tone design. But contrasting colors are also a popular option as they open up numerous possibilities for making large facades appear less monotonous. The same also applies to the actual moulded parts when used to achieve a visual rhythm.



Käpylän Posteljooni, Helsinki, Finland
Architect: Anttinen Oiva Architects, Helsinki, Finland
Year: 2017 / Products: KeraShape®



KeraShape®



Sustainable realisation of a colorful vision

The unique color concept of Finchley Memorial Hospital in London integrates the new building in the green, low-rise surroundings while simultaneously creating an agreeable ambience for staff, patients and visitors alike. An integral component of this concept is represented by the facade ceramics by AGROB BUCHTAL.

This three-floor complex with around 10,000 m² of useful space is to replace an ensemble of older predecessor buildings over the long term. It is distinguished by its immediate vicinity comprising therapeutic gardens, playgrounds and public greens. In order to harmoniously integrate the new clinic in this ambience, Murphy Philipps Architects collaborated with the color designer Frances Tobin to develop a color concept envisaging clearly-defined transitions from the outside in: the dominating shades of blue and green appear in the facades first before continuing – in declining degrees of saturation – into the internal orientation system as well as into the treatment and patients' rooms.

In designing the building shell, the architects relied on products from AGROB BUCHTAL: the facade cladding

comprises 3,500 slim ceramic panels and 2,000 ceramic rectangular tubes with a cross-section of 60 x 60 mm which were installed in front of the curved glass facades of the access areas. One of the particular features of these filigree elements 120 cm in length is the glaze applied on four sides, whereby the aim was to comply with high requirements which not only demanded absolutely uniform surface quality, but also color co-ordination between the two-dimensional ceramic panels, despite various manufacturing techniques. While developing the six color shades defined exactly by the planners, AGROB BUCHTAL took advantage of its many decades of experience with project-specific customised solutions and carried out extensive series of tests. The fact that such tasks are among the core competencies of the company is proven by its stock of more than 15,000 formulations for special colors in its in-house glaze laboratory.



KeraShape®



Finchley Memorial Hospital, Finchley, London, Great Britain / Architect: Murphey Philipps Architects, London, Great Britain
Year: 2012 / Products: KeraShape® / Photos: Benedict Luxmore





The entire project was determined by individuality and an attention to detail: apart from its pixelated colorfulness, the elements of only 15 cm height are characteristic for the facade panels mounted swiftly and subtly using concealed clamps thanks to the modern KeraTwin® K20 fastening system. Accordingly, the various lengths of between 63 and 120 cm, the six glaze colors and various mitre-cut profiles on the edges of the building gave rise to 84 different items, all of which were produced and cut precisely in the Schwarzenfeld plant in Bavaria. Against the backdrop of the subtly elegant architecture, the play by these color surfaces lends the new hospital its unique charm.

Environmental responsibility also played a central role when planning and realising the new building. This is also confirmed by the BREEAM certificate of sustainability awarding a top grade of "Excellent". Permanently fired into the ceramics, the HT coating by AGROB BUCHTAL also contributes to this award. It ensures that rainwater infiltrates dirt as a thin film and simply washes it away. Furthermore, HT has an antibacterial effect and prevents the development of moss and algae – highly efficiently and without chemicals, i.e. permanently clean, free of charge and environmentally neutral. And if that was not enough: HT-coated facades even break down industrial and car fumes.

Sustainable building for scientists

The Centre for Science, Technology and Innovation in the Argentinian capital of Buenos Aires is the first of its kind in Latin America – and it also sets architectural standards. Its shining white exterior and energetic optimisation are made possible by a rear-ventilated KeraTwin® facade by AGROB BUCHTAL.

Ministerio de Ciencia, Buenos Aires, Argentina / Architect: Arch. Juan Carlos Angelomé / Products: KeraTwin®, KeraShape®



KeraShape®

The Minister for Science Lino Barañao, whose department is housed in the new building complex along with research institutes and scientific organisations, regards the centre as a bridge between the past and the future of science in Argentina. The past – which rewarded the country with three Nobel Prizes in scientific areas – is also present in the form of some historical structures nearby: encompassing almost 45,000 m², the Centre was built on the site of a once famous winery which had fallen into disrepair over the years. Meanwhile, the buildings have not only been restored on the outside – they have also been practically integrated in the Science Centre.



The plans for the second construction phase lead the way into the future and will include an interactive science museum, a library, a media centre and auditoriums. This project is linked to an aspiration to provide knowledge to solve national problems, strengthen industrial productivity and create a new basis for social integration.

Sustainability plays a key role in the plans by the Argentinian architect Juan Carlos Angelomé. Water consumption, for example, was reduced by 50 per cent thanks to a treatment plant for process water. And solar thermal elements on the roof ensure the supply of hot water. Sustainability was also the clincher when selecting the KeraTwin[®] ceramic facade system by AGROB BUCHTAL. In total, approx. 8,000 square metres of white ceramic panels measuring 35 x 120 cm and 14 kilometres of rectangular tubes glazed on three sides were used as a rear-ventilated facade which covers all walls exposed to the sun. This construction enables the effects of solar radiation during the hot season to be reduced by more than 95 per cent – accompanied by the corresponding savings in air-conditioning. A key bonus for the architect Angelomé was also represented by the HT coating which generates a self-washing effect every time it rains, thereby guaranteeing that the building retains its shimmering white appearance.





KeraShape®



Ministerio de Ciencia, Buenos Aires, Argentina / Architects: Arch. Juan Carlos Angelomé /
Year: 2011 / Products: KeraTwin®, KeraShape®

A bank with style

Although the Raiffeisenforum Mödling sets some significantly contemporary highlights, it integrates seamlessly into the historic surroundings of the old town. This new building is also distinguished by manifold use and shines a spotlight on the topic of sustainability.

The curtain-type, rear-ventilated facade comprising KeraTwin® panels attributes the building an excellent energy footprint while simultaneously supporting the aesthetic concept pursued by the architects. Graded nuances of sand and filigree, three-dimensional ceramic elements in the area of the light strips attribute texture to the building while also picking up on the detailed design of its environment. In giving the building its cubic shape, there was a focus on the technical advantages of the ceramic system. Vertical wall and inclined roof areas were therefore possible throughout, which was an express request in Mödling. The construction without an offset in levels was possible by using various system profiles for the roof and walls.

Despite all of this clarity and modernity, the architecture still boasts an attention to detail, apparent in the special snow guard hooks on the sloping roofs which are significantly less conspicuous than conventional snow guards, but just as effective. When viewed from the street, they also represent a visual attraction.

And finally, this new building in the small town on the outskirts of Vienna also makes a key contribution to sustainability: the ceramic facade system is extremely weather-resistant and color-fast. Thanks to HT coating, each rain shower can be seen as a free wash preventing algae and moss from gaining a foothold. Furthermore, the facade also helps to keep the air clean by breaking down gaseous pollutants.

The jury for the Construction Prize of Lower Austria was sufficiently impressed by its architectural quality and skilful realisation to award it third place among 100 contestants.

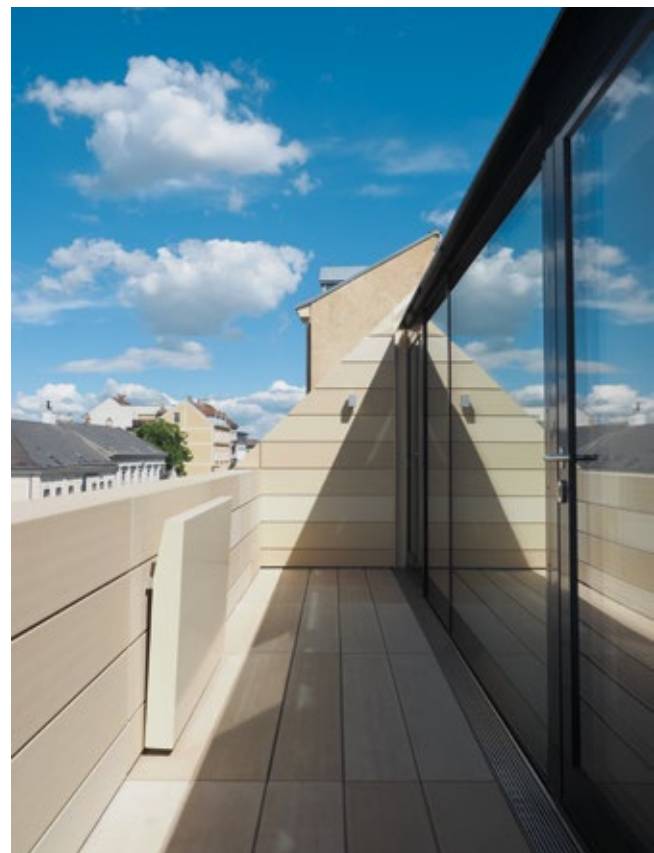

Raiffeisen Forum, Mödling, Austria
Architects: arge X42, Vienna, Austria
Year: 2014 / Products: KeraTwin®, KeraShape®
Photos: Rich Hiebl



KeraShape®



Eden Business Park Grotte Portella, Rom-Frascati, Italy / Architect: Daniela Capulli, Rome /
Year: 2012 / Products: KeraTwin®, KeraShape®



Breathing building

The Eden Business Park in the Via Grotte Portella was planned and realized according to strict targets set with regard to energy efficiency. A part of the concept also was the curtain-type, rear-ventilated facade as well as the shade-producing elements in front of the window areas, for which a total of eleven kilometres of rectangular tubes were installed.





Forms, colors and formats for KeraShape®

Whether as protection against view and sun or for giving large facade surfaces a rhythm – KeraShape® elements are extremely versatile and set visual accents. They are available as rectangular tubes with three or four glazed sides in three different cross-sections and lengths of up to 180 cm as well as in rounded lamellar form. The great variety of colors comprises the SpectraView range with its harmoniously matched color families with silky-matt glaze and glossy glazed contrasting colors as well as the unglazed Natura shades. On request, a special production according to individual specifications is also possible.

KeraShape® forms and formats



Rectangular tube
 50 x 60 mm / 60 x 60 mm
 Work size: 50 x 60 mm / 60 x 60 mm
 Weight: 50 x 60 mm: 4.29 kg / lin. m.
 60 x 60 mm: 4.49 kg / lin. m.
 available unglazed as well as with
 4 glazed sides. Possible up to
 a length of 1,800 mm on request



Rectangular tube
 50 x 100 mm*
 Work size: 50 x 100 mm
 Weight: 6.84 kg / lin. m.
 available unglazed as well as with
 4 glazed sides. Possible up
 to a length of 1,500 mm on request



Lamellar element
 Work size: 140 x 60 mm
 Weight: 9.00 kg / lin. m
 possible up to a length
 of 1,200 mm,
 available only unglazed

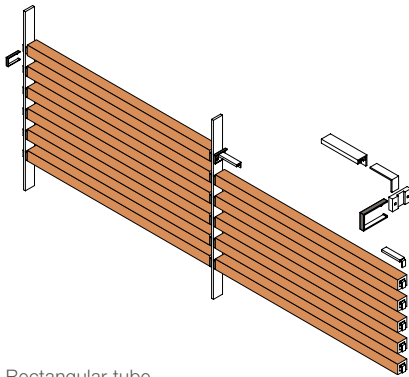

Rectangular tube

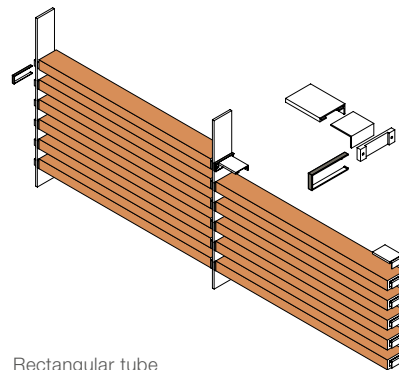

Rectangular tube

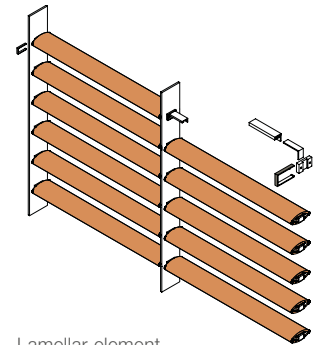

Lamellar element

Cross-section of rectangular tube

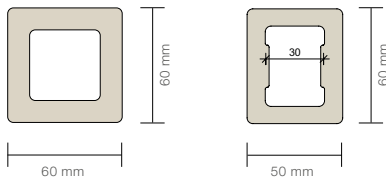

Cross-section of rectangular tube

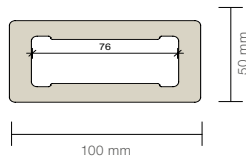

Cross-section of lamellar element

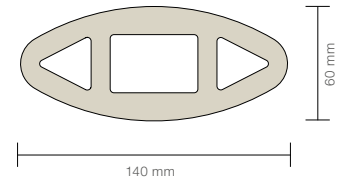

In addition to the variants shown, the production of individual articles is also possible. After a short check of the individual case for technical and economical feasibility, we will be pleased to provide you with project-specific information.

Matching rubber spacers available on request.

Mounting instructions for KeraShape®

Substructure

The mounting of the substructure must be carried out according to project-specific, static calculation.

- For horizontal laying, the mounting sets (Art. no. 606, 607) can be used.
- One has to decide whether only base plates with hole and counterbore or also with M5 thread in addition have to be used.
- The “supports for mounting parts” must be fixed in the special pieces by means of polyurethane adhesive.
- For vertical laying, the clamps (Art. no. 685, 686, 687 and 685R, 686R, 687R respectively) can be used.
- The clamps can be fastened with stainless steel screws (Art. no. 659).



Mounting instructions as video film:
www.agrob-buchta.de

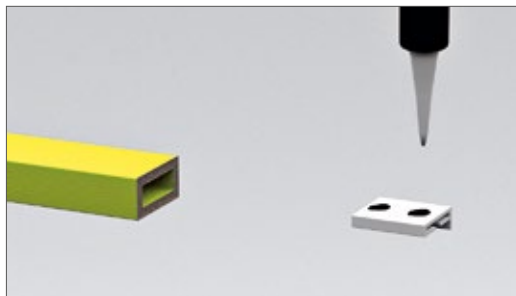

Punctually glue the support for mounting part in place with polyurethane adhesive

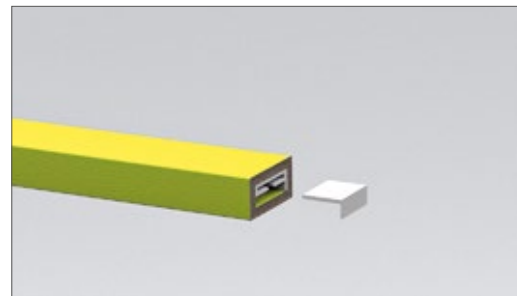

Slide angular insert in support for mounting part

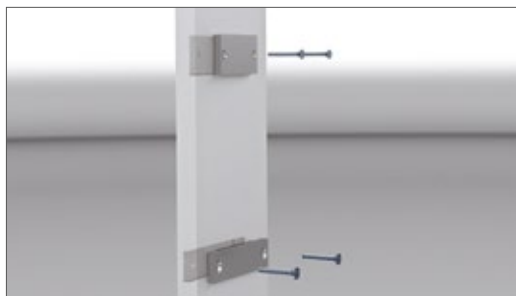

Fix base plate at the basic substructure

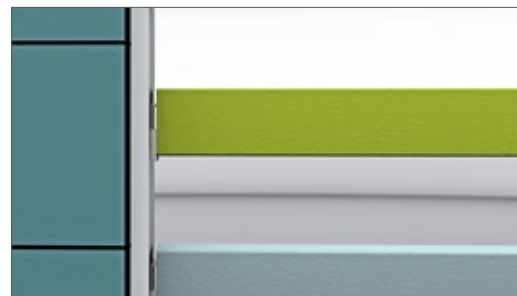

Hang the 3D Facade Ceramics with the angular insert in the base plate



Slide securing clip on the base plate

SpectraView glazed, silky-matt



6201 cream 1



6202 cream 2



6203 cream 3



6204 cream 4



6205 cream 5



6211 yellow 1



6212 yellow 2



6213 yellow 3



6214 yellow 4



6215 yellow 5



6221 apricot 1



6222 apricot 2



6223 apricot 3



6224 apricot 4



6225 apricot 5



6231 salmon-red 1



6232 salmon-red 2



6233 salmon-red 3



6234 salmon-red 4



6235 salmon-red 5

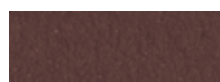

6241 pink 1



6242 pink 2



6243 pink 3



6244 pink 4

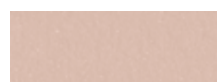

6245 pink 5

Contrasting colors, glazed, glossy



150 lemon-yellow



151 orange



152 apple-green



153 violet



154 contrasting red

Natura unglazed



407 white*



410 cream



411 ochre



412 salmon



396 salmon-red



414 light-grey



409 iron-grey



415 vulcan-grey

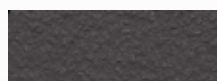

419 black*



416 smoky-blue*

* Not available as lamellar element special piece.





6251 neutral-grey 1



6252 neutral-grey 2



6253 neutral-grey 3

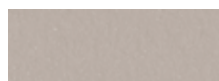

6254 neutral-grey 4

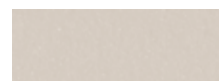

6255 neutral-grey 5



6261 grey 1



6262 grey 2

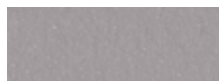

6263 grey 3



6264 grey 4



6265 grey 5



6271 blue 1



6272 blue 2



6273 blue 3



6274 blue 4



6275 blue 5



6281 green 1



6282 green 2



6283 green 3

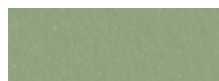

6284 green 4



6285 green 5

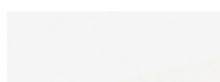

4230 glacier-white, glossy

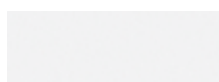

4234 chalk-white, matt



4530 black, glossy



4534 black, matt



144 intense blue



403 red



397 brick-red*



408 red-brown



418 brown*

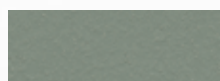

417 patina-green*

Due to production reasons, color deviations compared to the KeraTwin® panels as well as slight differences in nuances can not be excluded.



KeraShape® with horizontal laying

System description

Three-dimensional ceramic special pieces in natural colors or also in glazed version are used for making large facade surfaces less monotonous or for

producing shade at buildings. For developing individual, project-related fastening proposals, please contact us. Information about the standard fastening

systems is to be found in the respective technical details. Fastening sets are available for the horizontal laying.



- 1 Built-in unit
- 2 Angular insert
- 3 Base plate
- 4 Securing clip

Accessories: KeraShape® with horizontal laying Fastening sets:

The sets comprise: 1 built-in unit, 1 angular insert, 1 base plate, 1 securing clip (black)

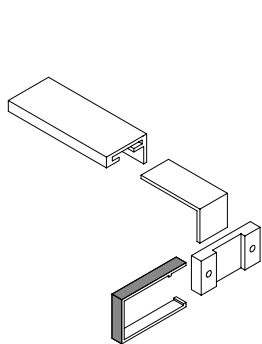

Article 606
For rectangular tube 60 x 50, 60 x 60 and lamellar element
Securing clip (black)
Base plate optionally available with M5 thread
Weight: 0.14 kg / set

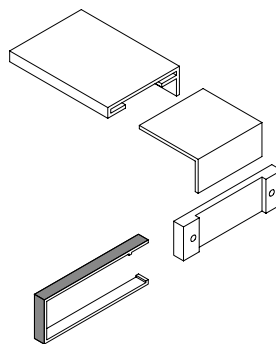

Article 607
For rectangular tube 50 x 100
Securing clip (black)
Base plate optionally available with M5 thread
Weight: 0.21 kg / set

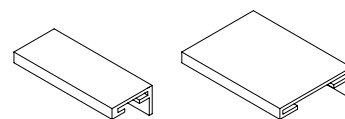

Built-in unit
also available as continuous profile on request

KeraShape® with vertical laying

System description

Rectangular tubes in various dimensions and colors in unglazed or glazed version can also be vertically installed. For developing individual, project-related

fastening proposals, please contact us. Special fastening clamps are available for all standard variants of the ceramic rectangular tubes.

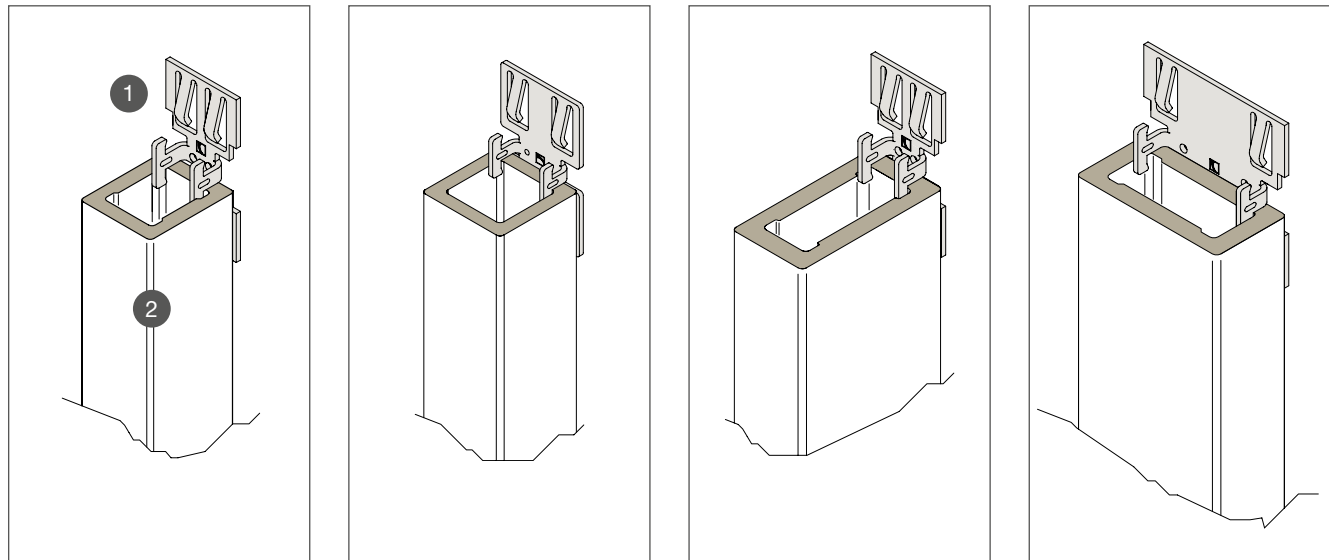

1 Fastening clamp

2 Rectangular tube

Accessories: KeraShape® with vertical laying

Fastening clamps:

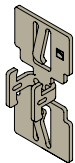

Article 685-50100
Twin-clamp
for 50 mm width in case of rectangular tube 50 x 100
Perforation: 2 x 4.9 mm
Material:
AlMg3 H22 (EN AW-5754)
painted black
Weight: 35 kg / 1,000 pcs.

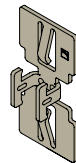

Article 685-5060
Twin-clamp
for 50 mm width in case of rectangular tube 50 x 60
Perforation: 2 x 4.9 mm
Material:
AlMg3 H22 (EN AW-5754)
painted black
Weight: 35 kg / 1,000 pcs.

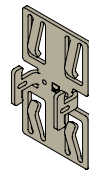

Article 686-6060
Twin-clamp
for 60 mm width in case of rectangular tube 60 x 60
Perforation: 2 x 4.9 mm
Material:
AlMg3 H22 (EN AW-5754)
painted black
Weight: 45 kg / 1,000 pcs.

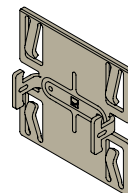

Article 687-10050
Twin-clamp
for 100 mm width in case of rectangular tube 50 x 100
Perforation: 2 x 4.9 mm
Material:
AlMg3 H22 (EN AW-5754)
painted black
Weight: 90 kg / 1,000 pcs.



Article 659
A4 stainless steel
screw, bright
Weight: 2.8 kg / box
Nominal dimensions:
4.8 x 16 mm
Box contents: 1,000
pieces + 1 bit

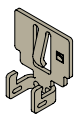

Article 685R-50100
Terminal-clamp
for 50 mm width in case of rectangular tube 50 x 100
Perforation: 2 x 4.9 mm
Material:
AlMg3 H22 (EN AW-5754)
painted black
Weight: 20 kg / 1,000 pcs.

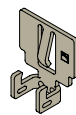

Article 685R-5060
Terminal-clamp
for 50 mm width in case of rectangular tube 50 x 60
Perforation: 2 x 4.9 mm
Material:
AlMg3 H22 (EN AW-5754)
painted black
Weight: 20 kg / 1,000 pcs.

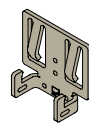

Article 686R-6060
Terminal-clamp
for 60 mm width in case of rectangular tube 60 x 60
Perforation: 2 x 4.9 mm
Material:
AlMg3 H22 (EN AW-5754)
painted black
Weight: 24 kg / 1,000 pcs.

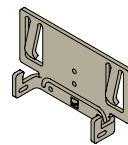

Article 687R-10050
Terminal-clamp
for 100 mm width in case of rectangular tube 50 x 100
Perforation: 2 x 4.9 mm
Material:
AlMg3 H22 (EN AW-5754)
painted black
Weight: 48 kg / 1,000 pcs.

KERAION®

CERAMICS IN LARGE FORMAT



Muhammad Ali Center, Louisville, USA / Architects: Lee H. Skolnick Architecture + Design Partnership/Beyer, Blinder Belle Architects & Planners LLP /
Year: 2005 / Products: KerAion® Quadro / Photos: Daniele Domenicali

Designing with colors

Used world-wide for decades, the KerAion® facade system also offers - besides low weight and special fastening technique - alternatives to the otherwise quite usual board formats. In addition to rectangular panels, square panels in the large formats of 60 x 60 cm, 90 x 90 cm and 120 x 120 cm are also available, which are particularly suitable for the facade design of big buildings.

All versions and formats received the general approval of the construction supervisory authority and also prove themselves in case of a statically demanding building structure. A high degree of creative freedom is ensured by the color range. It is based on SpectraView, the range of nine color families matched to each other and several contrasting colors, which was developed by the color designer Peter Zoernack. It is completed by the "Design glazed" colors.

The KerAion® panels can be installed both with visible and invisible fastening. KerAion® Quadro with a weight per unit

area of 18.5 kg/m² and a thickness of 8 mm is mounted either by means of clasps (in case of the standard dimensions of 60 x 60 cm and 60 x 90 cm) or bearing profile (formats 60 x 120 cm, 90 x 90 cm, 90 x 120 cm and 120 x 120 cm). KerAion® K8 (standard dimensions of 60 x 60 cm, 60 x 90 cm), also 8 mm thin and with a weight of 18 kg/m², is designed for the fastening by means of clasps. Optionally, safety tapes are available for all formats, which are applied to the panel reverse side already in-plant and prevent larger pieces from falling down if a panel is damaged.

Architects attaching importance to a particularly uniform joint pattern decide in favour of KerAion® Quadro with invisible fastening by means of clasps or bearing profiles (depending on the panel size). In addition, the system offers the advantage that a weakening of the facade panels by undercut anchors is avoided. KerAion® K8 with visible clamp fastening – with the color of the clamp lips being matched to the design of the ceramic panel – offers other advantages: above all the rapid installation with well thought-out system components, both on metal and wooden substructure.



Ceramic mega-puzzle

For more than a decade, the Muhammad Ali Center in Louisville (USA) has been regarded as a typical example of a new relationship between form and function in architecture. A key role in this design is played by ceramic tiles by AGROB BUCHTAL.

When architects in North America began to revise the dogmatic relationship between the form and function of a building, they saw many familiar materials in a new light or reinvented them entirely. Within this context, ceramic tiles – always valued on account of their durability and feasibility – were attributed new value as a versatile artistic medium. There are various reasons for the fact that they have asserted themselves in numerous renovations and new building projects. Apart from their robustness, sustainability and maintenance-friendliness, it was the extensive range of colors, shapes and textures in particular which fascinated the planners with artistic ambitions.

In Louisville (Kentucky), the birthplace of the boxing champion and human rights activist Muhammad Ali, KerAion ceramic panels were the material of choice: the graphic designs on the facade of the Muhammad Ali Center can be seen from afar and comprise almost 10,000 tiles in 30.5 x 61 cm format. While the Center spanning almost 9,000 square metres includes a museum, tolerance centre, Hall of Fame, archive and learning centre based on designs by Beyer Blinder Bell Architects & Planners LLP and Lee H. Skolnick Architecture + Design Partnership, the New York artist Glenn Cummings from the agency 2x4 was responsible for designing the facade. In doing so, he turned to photographs by Howard L. Bingham depicting the boxer in typical poses at the pinnacle of his career.

Built in a prominent location on the banks of the river, this building is an eye-catcher. From a distance, the figurative representations are easily recognised as such but as viewers draw closer, these pixelated images are stunningly transformed into abstract patterns.



Muhammad Ali Center, Louisville, USA
Architects: Lee H. Skolnick Architecture + Design
Partnership, Beyer Blinder Belle Arcitects & Planners LLP /
Year: 2005 / Products: KerAion® Quadro /
Photos: Daniele Domenicali

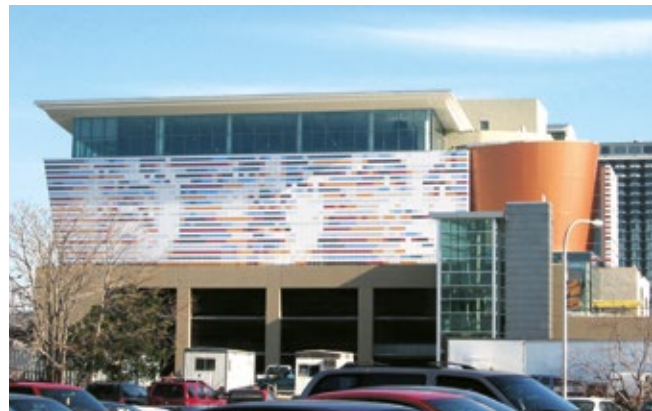



Pixel picture in XXL

Already the facade points to the purpose of the building: the Data-Center of the Shinhan Financial Group at Seoul shows an oversize pixel picture of a color gradient from dark-blue to white.



KerAion®

Beautiful architecture for daily use

Besides a large Migros branch, the multi-purpose building ensemble also houses restaurants, offices and flats of various sizes. The KerAion® elements in different formats lend the buildings a timeless look, which becomes visible above all at close range in interesting details.





KerAion®



Baarcity, Baar, Switzerland / Architect: Theo Hotz AG, Architekten + Planer /
Year: 2012 / Products: KerAion® Quadro / Photos: Adriano Faragulo





Surface finishes and formats for KerAion®

Thanks to its great variety of colors, formats and finishes, the KerAion® system offers plenty of scope for individual concepts. The modular formats rely on large-sized squares and rectangles, from 60 x 60 cm to 120 x 120 cm.

The silky-matt glazed “SpectraView” color range with its nine harmoniously co-ordinated color families and five shimmering glazed contrast colors is complemented by aesthetic design surface finishes. The glazed tiles are available with a HT coating in stone, cement, metal and wood designs.

Surfaces for KerAion®



Elegant look

With their smooth, silky-matt surface, KerAion® panels lend every facade an elegant look. Individual design concepts are supported by the wide color range.

KerAion® Quadro / KerAion® K8

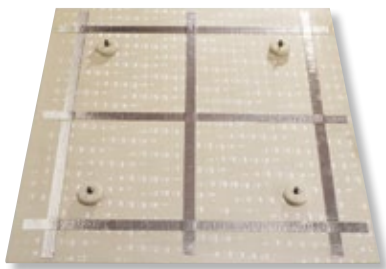

KerAion® Quadro with safety tape



KerAion® K8 with safety tape

Safety tapes

With the safety tapes, AGROB BUCHTAL optionally offers a safety system specially matched to the KerAion® facade panels. The safety tapes applied to the panel reverse side in-plant prevent larger pieces from falling down if panels are damaged mechanically.

Formats for KerAion® Quadro

Extruded Ceramic Panels, Precision, DIN EN 14411, group Alb,
glazed (GL), (large-size stoneware panels), 8 mm thick, 18.5 kg/m²

Standard sizes (grid size / work size) invisible fastening with clasps:
60 x 60 cm / 592 x 592 mm, 60 x 90 cm / 592 x 892 mm
invisible fastening with bearing profile: 60 x 120 cm / 592 x 1192 mm, 90 x 90 cm /
892 x 892 mm / 90 x 120 cm / 892 x 1192 mm, 120 x 120 cm / 1192 x 1192 mm
Other sizes available on request.

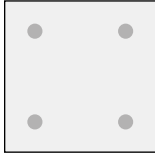

Fastening with clasps

Article Q100HK
60 x 60 cm



Article Q104HK
60 x 90 cm



Fastening with bearing profile

Article Q418HK
60 x 120 cm

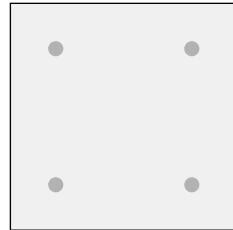

Article Q416HK
90 x 90 cm

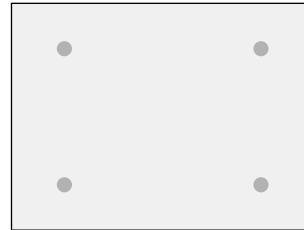

Article Q414HK
90 x 120 cm

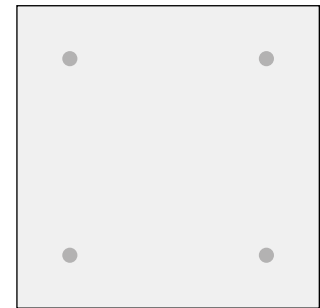

Article Q422HK
120 x 120 cm

Formats for KerAion® K8

Extruded Ceramic Panels, Precision, DIN EN 14411, group Alb,
glazed (GL), (large-size stoneware panels), 8 mm thick, 18 kg/m²

Standard sizes: (grid size / work size) 60 x 60 cm / 592 x 592 mm, 60 x 90 cm / 592 x 892 mm,
90 x 90 cm / 892 x 892 mm, 60 x 120 cm / 592 x 1192 mm
Other sizes available on request.

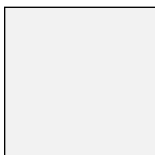

Clamp fastening

Article K100HK
60 x 60 cm



Article K104HK
60 x 90 cm

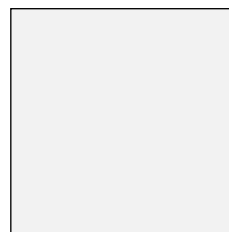



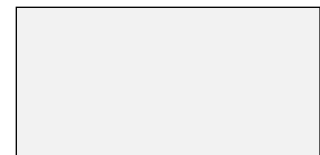









































Article K416HK
90 x 90 cm



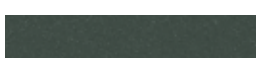

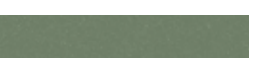
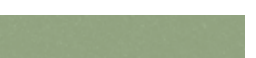
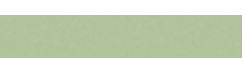
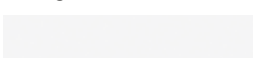
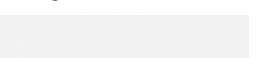



Article K418HK
60 x 120 cm

SpectraView glazed, silky-matt

				
6201 cream 1 H	6202 cream 2 H	6203 cream 3 H	6204 cream 4 H	6205 cream 5 H
				
6211 yellow 1 H	6212 yellow 2 H	6213 yellow 3 H	6214 yellow 4 H	6215 yellow 5 H
				
6221 apricot 1 H	6222 apricot 2 H	6223 apricot 3 H	6224 apricot 4 H	6225 apricot 5 H
				
6231 salmon-red 1 H	6232 salmon-red 2 H	6233 salmon-red 3 H	6234 salmon-red 4 H	6235 salmon-red 5 H
				
6241 rosé 1 H	6242 rosé 2 H	6243 rosé 3 H	6244 rosé 4 H	6245 rosé 5 H
				
6251 neutral-grey 1 H	6252 neutral-grey 2 H	6253 neutral-grey 3 H	6254 neutral-grey 4 H	6255 neutral-grey 5 H
				
6261 grey 1 H	6262 grey 2 H	6263 grey 3 H	6264 grey 4 H	6265 grey 5 H
				
6271 blue 1 H	6272 blue 2 H	6273 blue 3 H	6274 blue 4 H	6275 blue 5 H
				
6281 green 1 H	6282 green 2 H	6283 green 3 H	6284 green 4 H	6285 green 5 H
				
	4230 glacier-white, glossy H	4234 chalk-white, matt H	4530 black, glossy H	4534 black, matt H





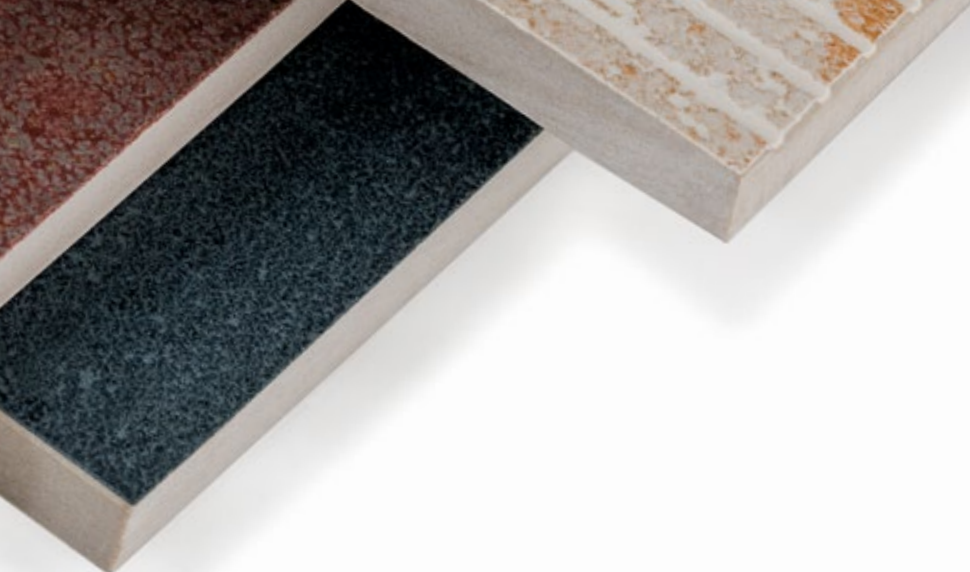









Contrasting colors glazed, glossy

				
150 lemon-yellow H	151 orange H	152 apple-green H	153 violet H	154 contrasting red H
				
144 intense blue H				





Design glazed



Stone

			
1100 Stonewall 1 H	1115 Rockface 1 H	1090 Haze 1 H	1110 Mega 1 H
			
1101 Stonewall 2 H	1116 Rockface 2 H	1091 Haze 2 H	1111 Mega 2 H
			
1102 Stonewall 3 H	1117 Rockface 3 H	1093 Haze 3 H	1112 Mega 3 H
			
1103 Stonewall 4 H		1092 Haze 4 H	



Cement

1140 Construct 1 H

1141 Construct 2 H

Metal

1180 Metal 1 H

1181 Metal 2 H

1182 Metal 3 H

Wood

1170 Bosco 1 H

1171 Bosco 2 H

1172 Bosco 3 H



H = HT coating

In addition to the variants shown, the production of individual articles is also possible. After a short check of the individual case for technical and economic feasibility, we will be pleased to provide you with project-specific information.

The colors "Design glazed" can be supplied for the system KerAion® up to a panel width of 60 cm.

KerAion® Quadro with invisible fastening (clasps / bearing profile)



System description

Quadro fastening points (ceramic composite element) with integral stainless steel screw are sinter-fused on the reverse side of the KerAion® Quadro facade panels in a special firing process. On these fastening points, clasps (up to the size of 60 x 90 cm) or a bearing profile (up to the size of 120 x 120 cm) can be screwed by means of which the facade panels are hung in the substructure.

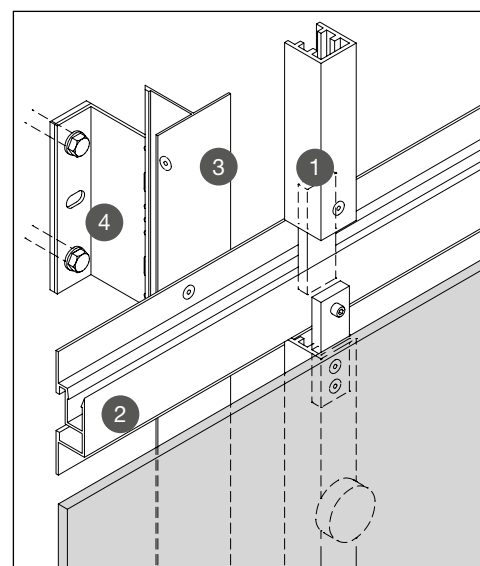

KerAion® Quadro fastening with bearing profile

- 1 Facade panel KerAion® Quadro
- 2 Quadro fastening point
- 3 Clasp with adjusting screw
- 4 Horizontal bearing profile for clasp fastening (basic substructure)
- 5 Vertical bearing profile (basic substructure)
- 6 Wall bracket (basic substructure)

- 1 Bearing profile (basic substructure)
- 2 Horizontal bearing profile for fastening with bearing profile (basic substructure)
- 3 Vertical bearing profile (basic substructure)
- 4 Wall bracket (basic substructure)



Mounting instructions as video film:
www.agrob-buchtal.de

Mounting instructions for KerAion® Quadro – with invisible fastening (clasps / bearing profile)

Substructure

The mounting of the substructure must be carried out according to project-specific, static calculation. The general approvals Z-10.3-725 (clasps) and Z-10.3-724 (bearing profile) of the construction supervisory authority serve as basis.

Quadro clasp

- The vertical profiles have to be mounted perpendicularly and in a flush way.
- The distance of the horizontal “clasp profiles“ depends on the Quadro fastening points on the reverse side of the panels.
- Use neoprene rubber washer (Art. no. 371) between clasps and Quadro.
- Fasten clasps with self-locking stainless steel nuts (Art. no. 370) with 2.5 Nm.

Quadro bearing profile

- The bearing profiles must have fixed and sliding points, see approval Z-33.1-27.
- Fastening: Fasten Quadro – neoprene rubber washers (Art. no. 371) – bearing profile – with self-locking stainless steel nut (Art. no. 370) with 2.5 Nm.



Basic substructure

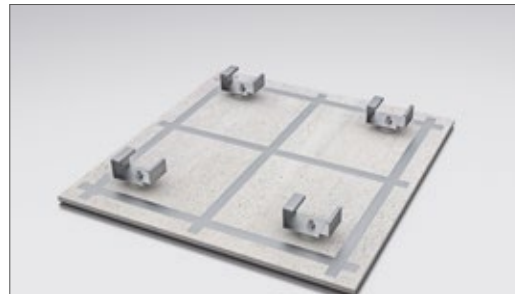

Screw clasps with rubber washer (Art. no. 371) and stainless steel nut (Art. no. 370) on the Quadro fastening points on the reverse side of the panels



Hang the KerAion® panels with the clasps on the reverse side in the horizontal rails

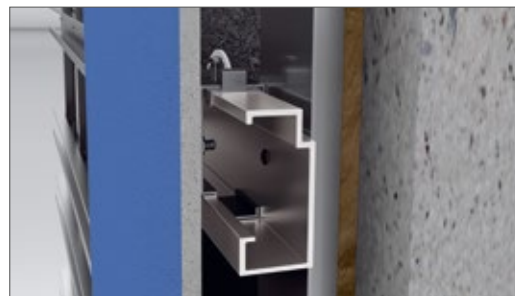

Align panel with screw and fix one clasp with clip

Accessories: KerAion® Quadro – with invisible fastening (clasps / bearing profile)



Article 370
Stainless steel nut,
self-locking,
Weight: 2 kg / 1,000 pieces
Nom. dimen.: M6



Article 371
Rubber washer, neoprene
Weight: 1 kg / 1,000 pieces
Nom. dimen.: 30 x 1.5 mm

Important: The use of silicone caoutchoucs must be absolutely avoided, because silicone fluids segregate and effect sticky surfaces on which dirt adheres. Therefore, only use the system components mentioned (foamed pieces, EDPM rubber profile, neoprene rubber washer) and pointing, bonding and sealing materials recommended by us. We will be pleased to inform you in detail. The usual final cleaning after completion of the construction works is still required.

KerAion® K8 with visible clamp fastening

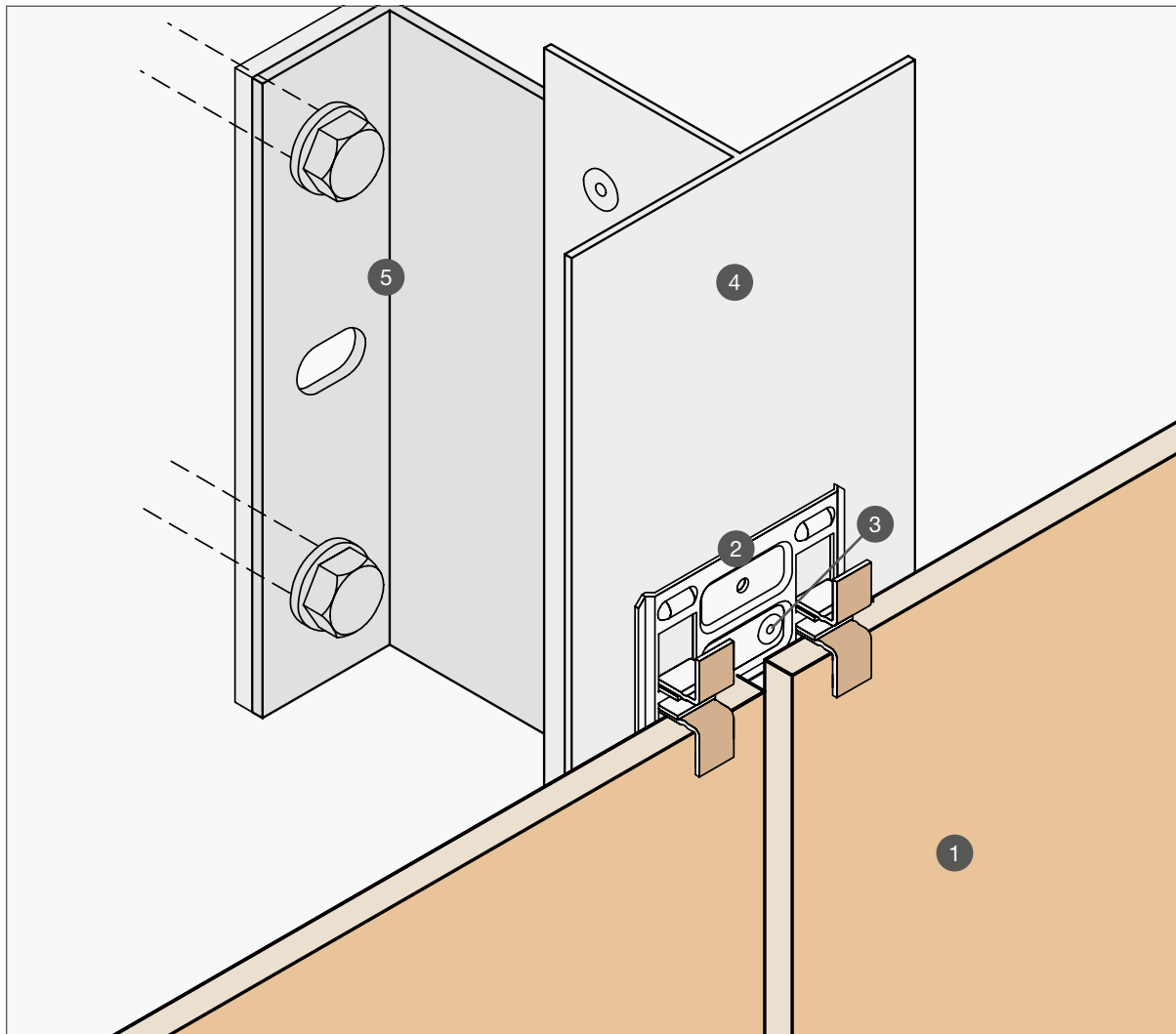

System description

The KerAion® facade panels are fixed on the substructure by means of the stainless steel clamps K8. The color of the clamp lips is matched to the panel design. To prevent clattering and constraining forces in the case of alternating wind loads, the facade panels are installed on the substructure in a nonrigid way by means of foamed pieces or alternatively with polyurethane.

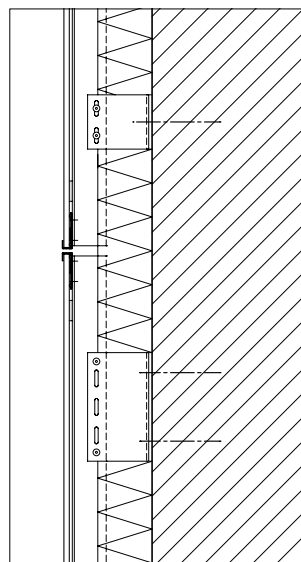

- 1 Facade panel KerAion® K8
- 2 Twin-clamp K8, article 545
- 3 Stainless steel blind rivet, article 675
- 4 Vertical bearing profile (basic substructure)
- 5 Wall bracket (basic substructure)



A profile butt joint of the vertical bearing profiles behind a panel is not allowed! See standard technical detail drawings.

Mounting instructions for KerAion® K8 with visible clamp fastening

Substructure

The mounting of the substructure must be carried out according to project-specific, static calculation. The general approval Z-10.3-776 of the construction supervisory authority serves as basis.

- The profiles have to be mounted perpendicularly and in a flush way.
- The length of the profiles must be divisible by the height of the panel format and should not exceed the height of a storey of the building (approx. 3 m).
- A profile butt joint of the vertical profiles behind a panel is not allowed.
- The stainless steel clamps K8 (Art. no. 545, 546, 547, 548, 549) must be fastened with stainless steel rivets (Art. no. 675).
- For the nonrigid installation of the panels, foamed pieces (Art. no. 347-01) or, alternatively, polyurethane have to be used.

Accessories for KerAion® K8 with visible clamp fastening

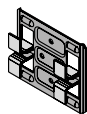

Article 545
Twin-clamp K8
Weight: 20 kg / 1,000 pieces
Perforation: 4 x 3.3 mm Ø
Base plate: painted black
Lips: painted similar to panel color
Material: 1.4571

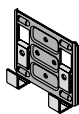

Article 546
Edge-clamp K8
Weight: 20 kg / 1,000 pieces
Perforation: 4 x 3.3 mm Ø
Base plate: painted black
Lips: painted similar to panel color
Material: 1.4571

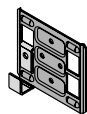

Article 547
Edge-clamp K8, left
Weight: 20 kg / 1,000 pieces
Perforation: 4 x 3.3 mm Ø
Base plate: painted black
Lips: painted similar to panel color
Material: 1.4571

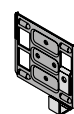

Article 548
Edge-clamp K8, right
Weight: 20 kg / 1,000 pieces
Perforation: 4 x 3.3 mm Ø
Base plate: painted black
Lips: painted similar to panel color
Material: 1.4571

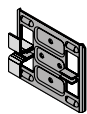

Article 549
Single-clamp K8
Weight: 20 kg / 1,000 pieces
Perforation: 4 x 3.3 mm Ø
Base plate: painted black
Lips: painted similar to panel color
Material: 1.4571



Article 675
Stainless steel blind rivet, black
Weight: 1.05 kg / box
Nominal dimensions: 3.2 x 9.5 mm
Box contents: 500 pieces
extended mandrel (58 mm)



Article 347-01
Foamed piece*
Weight: 1.80 kg / roll
Nominal dimensions:
20 x 30 x 8 mm
Roll: 1,380 pieces / roll
self-adhesive

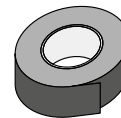

Article 506
Joint tape, black
Weight: 0.5 kg / roll
Nominal dimensions:
40 mm wide, 50 m
self-adhesive, weather-resistant

* Alternatively, nonrigid installation is also possible with PUR or MS polymer bonding materials. Suitable products on request.

Important: The use of silicone caoutchoucs must be absolutely avoided, because silicone fluids segregate and effect sticky surfaces on which dirt adheres. Therefore, only use the system components mentioned (foamed pieces, EDPM rubber profile, neoprene rubber washer) and pointing, bonding and sealing materials recommended by us. We will be pleased to inform you in detail. The usual final cleaning after completion of the construction works is still required

KerAion® detail solutions

Critical corners and terminations of all types can also be perfectly executed with KerAion® with regard to aesthetics and building physics. Rectangular corner profiles, 3D profiles and radial corner pieces offer safety and design freedom at the same time. For window

and door reveals, special solutions with invisible fastening by means of clasps are available. All detail solutions are adapted to the project-specific requirements as special production if required.

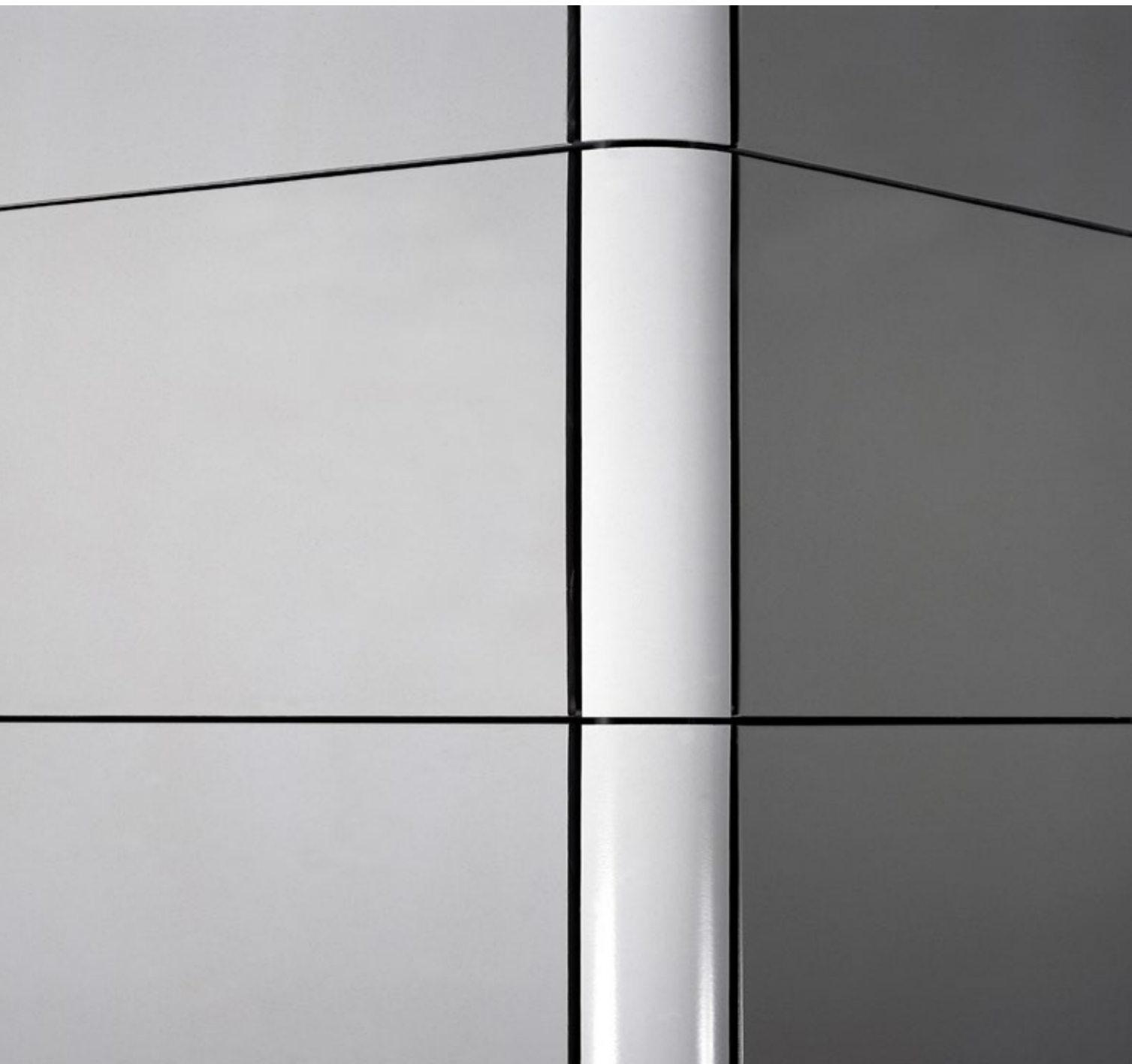

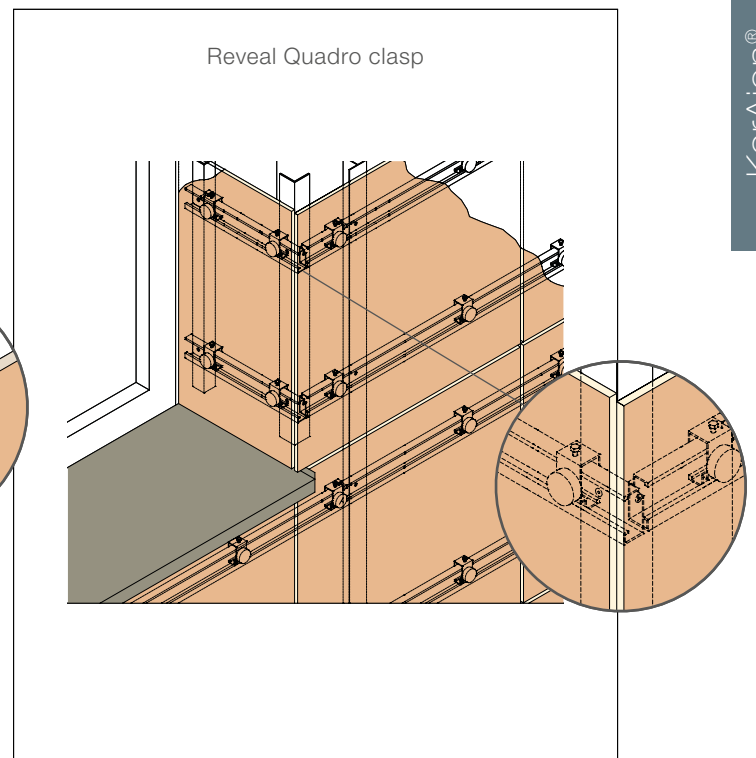
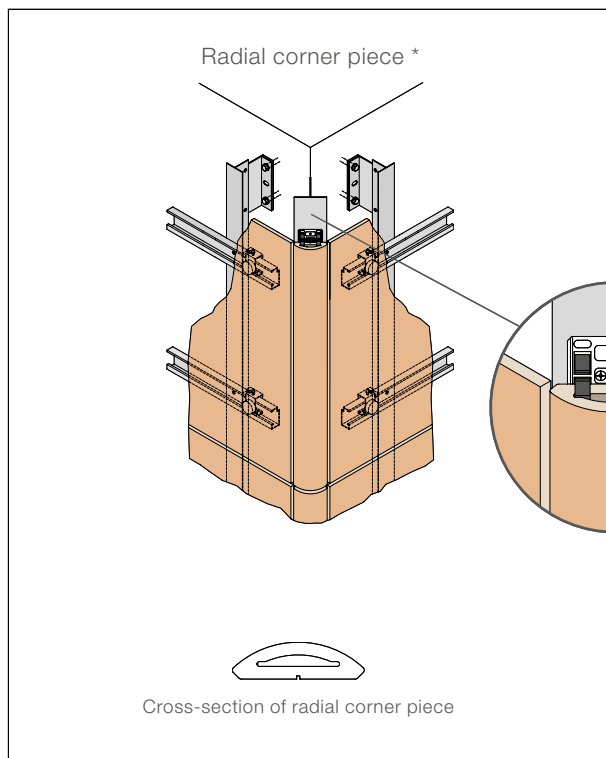
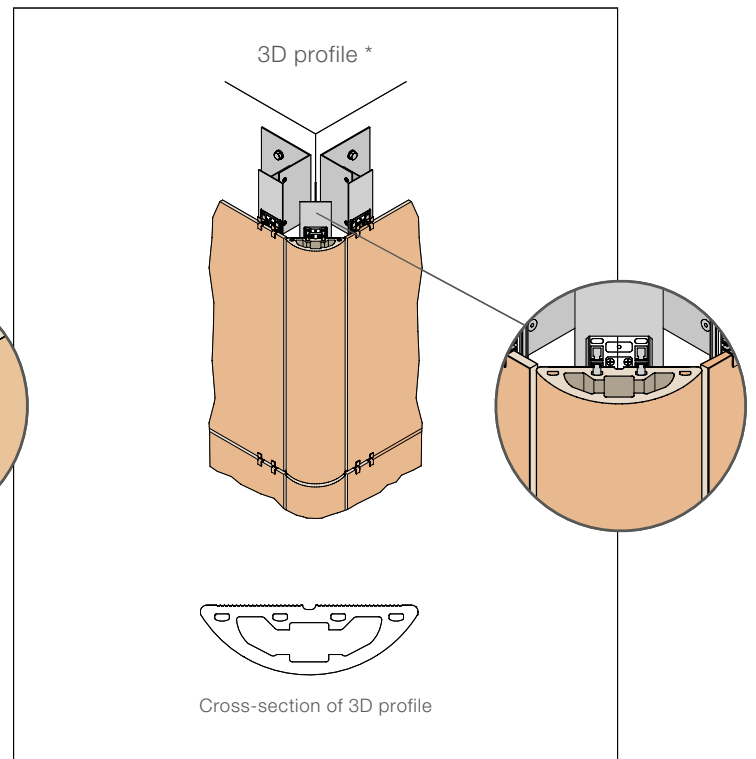
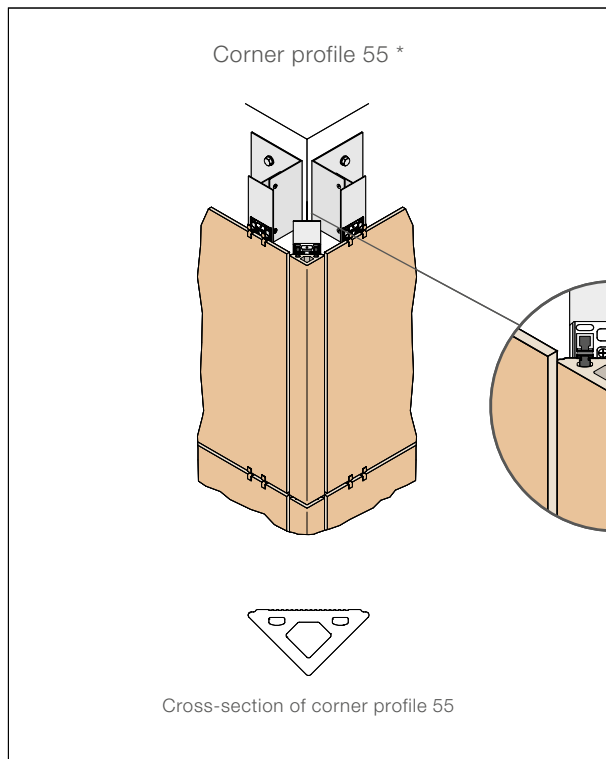

* product-specific details, project-related on request.

KERAYOU®

MORE THAN JUST STANDARD

AGROB BUCHTAL sees its most important task in offering architects and planners the design scope which they need for the realization of their creative ideas.

With approximately 20,000 glaze color recipes and an enormous variety of formats and surface structures, the company meets this requirement in most of all cases. However, AGROB BUCHTAL shows its true strength whenever innovative architectural concepts require an individual production. For the Design Department, the Product Management and the In-House Planning Department, the development of project-specific special solutions in co-operation with architects as partners is part of the core business.

This not only applies to special formats or colors corresponding to the ideas of the planner – or the CD specifications of a company. Innovative techniques such as the precise water-jet cutting as well as photographic and screen printing methods, which permit the transfer of complex artworks onto ceramics, open up new horizons for creative facade design. Artists which – in agreement with the architect – wish to actively participate in the realization of their creations are welcome at AGROB BUCHTAL. And also special solutions which have not been mentioned here (so far) are checked for their feasibility in an unbureaucratic manner – as soon as the creative concept of an architect requires new solutions.



New QEII



Queen Elizabeth Hospital London, Great Britain / Architect: Penoyre & Prasad LLP /
Year: 2015 / Products: KeraTwin®, special colors / Photo: Tim Crocker

KeraYou®

Colorful everyday life

In Örnsköldsvik on the Gulf of Bothnia in northern Sweden, the architect Gert Wingårdh has developed a soaring residential complex in the town. Wingårdh is regarded as one of Sweden's most interesting architects.



On top of the old town hall, originally a rough concrete block, the architect has arranged a playful building with "birdhouses" on the outside and windows facing in three directions. The facade features bright green, red, yellow and white KeraTwin® tiles mounted on a metal substructure. The color range is inspired by the Swedish expressionist painter Bengt Lindström of international renown. The "birdhouses" project at various lengths from the main building and create a shadow effect similar to the reliefs in Lindström's paintings. The sculptural and dramatic residential complex in the otherwise low-rise architecture on the Gulf of Bothnia is a colorful example of everyday architecture.



Ting 1, Örnsköldsvik, Sweden / Architect: Wingårdh Arkitektkontor AB, Göteborg/Stockholm/Malmö / Year: 2013 / Products: KeraTwin® (K20), special colors / Photos: Tord-Rikard Söderström (Wingårdhs)



A place to eat and meet

Grimshaw's transformation of Duke University's West Campus Student Union building in Durham, North Carolina, USA, is one of the eight shortlisted projects for the "AJ100 Building of the Year Award 2017".

This competition is organised by the Architect's Journal. Grimshaw's project comprises the careful renovation of an existing neo-gothic building, designed in the late 1920s by Julian Abele from the Horace Trumbauer office, and an expansion, which forms the core of the complex. The central part is an atrium made of glass, steel and ceramic elements manufactured by AGROB BUCHTAL.

The West Union building contains community facilities for Duke University's students, faculty and alumni, with a large dining space as its social epicenter. This environment to "eat and meet", in the parlance of the university, hosts 13 different kitchens and operates as an upscale, academic version of the food court usually found in shopping malls. This social hub of the campus was designed by Grimshaw Architects, a global practice, founded by Nicholas Grimshaw in 1980. This project was designed at Grimshaw's New York office, with facade consultancy from Front Inc.

The most prominent part of this extensive project is a transparent atrium which has replaced the central part of the original building. The glass, steel and ceramics of the atrium are perfectly in scale with the existing building,

which forms a U-shaped embrace of it. Architecturally speaking, the atrium is completely different in its expression from West Union's sturdy yet elegant neo-gothic design, which was a preferred style for American university buildings well into the twentieth century. The new addition in no way resembles the existing architectural landscape, but despite its distinctive expression, it manages to blend in naturally.

Instead of opting for total transparency, which would have maximised the contrast with the existing neo-gothic brick and stone massiveness, Grimshaw has opted to delicately trim it back, by framing the glass in steel and ceramics. The ceramic elements are a relatively small part of the new building, yet they play a particularly crucial one in its overall effect. From many perspectives, these terracotta elements seem to close the side elevations, which only completely open up when viewed straight on. Open yet visually closed, the architecture of the facades is an apt metaphor for how this transformation manages to balance old and new.





KeraYou®



Duke University, Durham, USA / Architect: Grimshaw Architects with Front Inc. /
Year: 2016 / Products: KeraShape®-facade elements / Photos: Duke photography



Glazed ceramics for the Museum der Kulturen

The view of Basel, European centre of culture, is unforgettable. Those looking down over the homogeneous roof landscape from the heights of the Basel Minster will however invariably be transfixed by an unusual feature: the light-reflecting roof of the Museum der Kulturen designed by Herzog & de Meuron.

This roof stands out as it alternates in color from green to black, shimmers and glitters depending on the incidence of light and the observer's perspective.

Yet it is a novelty which exhibits familiar features in the form of the plain tiles typical of the roofs in Basel's old quarter. Around 10,000 individual tiles were applied here as an abstract variant reinterpreting the prevailing traditions. As one of Europe's most significant ethnographic museums, the Museum der Kulturen whose new roof glitters in the sun is home to more than 300,000 objects from Europe, Africa, America, Oceania, Indonesia, South, Central and East Asia. Exhibits which convey a "cultural awareness in terms of confronting the unknown", "in order to view familiar objects in a different light", according to the Museum's Web site. This new and unusual roof has crowned the building since 2011 putting the extensive history of the Museum in a contemporary context thanks to its representative and modern design.





KeraYou®



Museum of Cultures, Basel, Switzerland / Architect: Herzog & de Meuron, Basel, Switzerland /
Year: 2010 / Products: individual production / Photos: Adriano Faragulo



Expressive pattern

The contractor Frans Haks, who was Museum Director at the time, and the architect and designer Alessandro Mendini created a true monument of post-modernism in the water of the connecting canal on the edge of Groningen city centre.

The decoration on the section developed by Mendini himself is blatantly obvious in the form of the pattern on the facade (Philippe Starck and Coop Himmelb(l)au were also responsible for sections of the museum). This pattern harks back to the embellishments on Mendini's most famous armchair design – the Proust Armchair in 1978 – in which the decoration is based on enlargements of a pointillist painting by Paul Signac. (There is hardly any better proof of the fact that originality is concealed by intelligence in post-modernism than simply by referring to the past.) When the museum was built in the early 1990s, this pattern was photo-printed onto laminate. The effects of sunlight however caused the print to all but practically fade. During the course of recent renovations of the museum building, a colorful alternative was chosen comprising ceramic tiles manufactured by AGROB BUCHTAL in collaboration with Koninklijke Tichelaar in Makkum. Tichelaar is a well-known Dutch company which not only manufactures special decorative stoneware, often collaborating with outstanding artists and designers, but is also involved in all kinds of building projects. In this case, the Signac pattern by

Alessandro Mendini, the leading architect of the museum building, was realised in a silkscreen glaze on large-format tiles (KerAion system) measuring max.1.28 x 1.28 metres and manufactured by AGROB BUCHTAL. Enabling the Signac pattern to once again undergo a metamorphosis.

A decorative interest is meanwhile being displayed by many designers. For example: Branimir Medić and Pero Puljiz from de Architekten Cie, who have used specially developed facade elements in various larger projects. Originally from Croatia, Medić and Puljiz have been active in the Netherlands since the 1990s and it is exactly this background which gives them such a keen eye for what is typically Dutch. One of their projects features the bright orange traditionally used for sun shade systems in the Netherlands while they have reinterpreted the typical blue of Delft in another project. The facade of the power station in Enschede is clad in panels featuring motifs based on a design by the artist Hugo Kaagman, who has often lent the traditional blue of Delft a new pep over the course of his career.



Groninger Museum, Groningen, the Netherlands / Architect: Alessandro Mendini, Milan, Italy / Year: 2010 / Products: KerAion®, clamp fastening / Photos: Koninklijke Tichelaar Makkum

Mega makeover

The extension of Mega, the large shopping mall in Kaunas, has been an opportunity for a make-over of the organization and appearance of the complex. The architect Saulius Mikštas of FORMA has designed an additional 30,000 square metres to an already substantial 70,000 square metres of retail, built a bit more than a decade ago, near the intersection of the A1 and A5 at the northern edge of the city.





KeraYou®

Despite being smaller than what was already there, the extension completely changes the character of the mall, by departing from the conventional and ubiquitous shopping mall model of having a big recessed volume with a large parking lot in front of it. The extension basically fills up the former parking lot. Aside from using the land more efficiently, it gives the mall a more prominent presence to motorists passing on the highway.

The added volume consists of stores on street level and a three-level parking structure on top of it, plus a unified screen around the whole complex. Both new and existing buildings are covered in ceramics of AGROB BUCHTAL, totalling 7,000 square metres. The elevations are made out of large, volcanic-grey KeraTwin® K20 ceramic panels (of 30 x 120 cm). The same material has been used for the office building next door of Kesko Senukai, the owner of the mall. This uniformity helps to further ordering this previously rather jumbled environment.

The unified facade covers a diversity of structures and construction systems behind it. A part of the ceramic facade is directly attached to insulation panels; in other parts, it was fixed on a steel and concrete structure for which a custom-made solution was engineered.

The elevation of the parking structure is partially opened up. The ceramic panels work here as louvres, allowing for air ventilation within the parking building. All ceramic tiles have a special HT coating which cleans the air of pollutants through a photocatalytic process. With a surface of this size it equals the effect of a small deciduous forest. It won't eliminate all the air pollution caused by passing traffic and the visitors to the mall, many of whom come by car, but it contributes significantly to the reduction of it.





KeraYou®



Mega Mall, Kaunas, Lithuania / Architect: UAB Forma, Vilnius, Lithuania / Year: 2016 /
Products: KeraTwin® (K20) / Photos: Leonas Garbačas

SERVICE

Buildings which set standards can only evolve if the service is as good as the product. AGROB BUCHTAL has been committed to this idea for generations.

One of the best examples is represented by the In-house Planning Department which has been offering sound consulting and handling of routine tasks for more than 60 years and in partnerships based on collaboration, enabling architects and planners to concentrate fully on their creative tasks.

A quick summary of which facade system is suitable for which application is provided by the system overview on the following pages, supplying basic information on the possible applications for ceramic facade systems offered by AGROB BUCHTAL. Whether it's about the possible type of installation, suitability for certain bases or the accessories available – all of the details are summarised here and can be taken in in only a few glances.

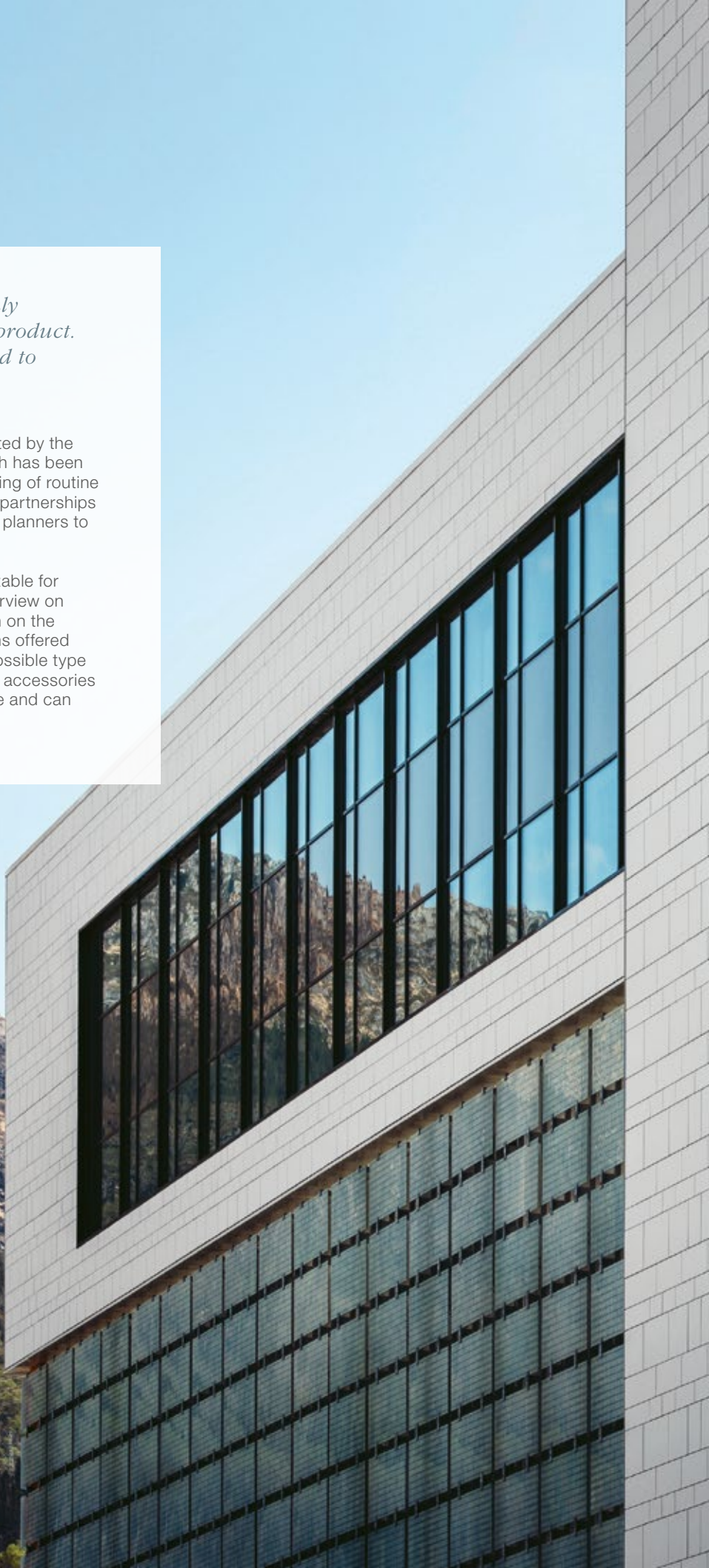



Fabrikkgatan, Bergen, Norway / Architect: Ramboll Norge AS Div Arkitekter / Products: KeraTwin® / Photo: Morten Wanvik

Overview and advantages: Fastening systems

KERATWIN®

Category

System profile

T-profile

Omega profile

OmegaV

System description

- Flexible pre-assembled height grid
- Very good assembly and adjustment possibilities thanks to separate basic and system profiles
- Wall connections (bracket or strut) can be used to achieve thermal and static requirements
- Used to achieve the required energy savings

- Flexible pre-assembled height grid
- Wall connections (bracket or strut) can be used to achieve thermal and static requirements
- Used to achieve the required energy savings

- Flexible pre-assembled height grid
- Lateral elongated holes permit tension-free assembly in terms of thermal linear deformation
- Easy assembly on studded wall partitions or smooth load-bearing surfaces
- overhead assembly possible thanks to additional securing brackets

- Horizontal profiles can be mounted on vert. constructions and on studded partition walls
- Horiz. panel heights can vary
- Offset formations are easy to realise
- Wall connections (bracket or strut) can be used to achieve thermal and static requirements
- Used to achieve the required energy savings

Possible installation methods

Horizontal, offset formation

Horizontal, offset formation

Horizontal, offset formation

Horizontal, free formation

Particularly suitable for the following wall structures

- Fastening level:**
- Solid wall constructions, e.g. masonry, concrete

- Fastening level:**
- Solid wall constructions, e.g. masonry, concrete

- Fastening level:**
- Skeleton constructions, e.g. studded partition walls, sandwich panels
 - Solid wall constructions, e.g. concrete
 - Static load-bearing

- Fastening level:**
- Skeleton constructions, e.g. studded partition walls, sandwich panels
 - Solid wall constructions, e.g. masonry, concrete

Advantages for facade designers

- Very good assembly and adjustment possibilities thanks to separate basic and system profiles
- Fastening elements in the height grid are already integrated in the system profiles
- Easy assembly at connection points, e.g. corners, soffits etc.
- Very fast assembly of panels
- Easy to replace or subsequently install individual panels

- No basic profile required as the fastening elements are already integrated in the K20 T-profile height grid
- Exact assembly of the K20 T-profiles required
- Easy assembly at connection points, e.g. corners, soffits etc.
- Very fast assembly of panels
- Easy to replace or subsequently install individual panels

- Flexible fastening
- Tension-free fastening to smooth surfaces is possible
- Fastening elements are already integrated in the K20 Omega profile height grid
- Easy assembly at connection points, e.g. corners, soffits etc.
- Very fast assembly of panels
- Easy to replace or subsequently install individual panels

- Tension-free assembly of the horiz. supporting profiles thanks to oblong holes
- Flexible positioning of the K20 OmegaV profiles
- Very fast assembly of panels
- Easy to replace or subsequently install individual panels

Approvals

Z-33.1-1175

Z-33.1-1175

Z-33.1-1175

Verification of applicability by an expert opinion analogue to the abZ Z-33.1-1175

Accessories available

System profiles, joint profiles, corner profiles, soffit profiles, joint spacers, fastening elements (screws or rivets)

T-profiles, joint profiles, corner profiles, soffit profiles, joint spacers

Omega profiles, joint profiles, corner profiles, soffit profiles, joint spacers, fastening elements (screws or rivets)

OmegaV profiles, horizontal supporting profiles, joint profiles, corner profiles, soffit profiles, joint spacers, fastening elements (screws or rivets)

OmegaS Clamp system

OmegaS

Clamp system

- Flexible pre-assembled height grid
- wall connections (bracket or strut) can be used to achieve thermal and static requirements
- Used to achieve the required energy savings
- K20 Omega profiles mounted in the single-beam element with cantilever arms
- Exact horiz. alignment by OmegaS profiles

- Wall connections (bracket or strut) can be used to achieve thermal and static requirements
- Used to achieve the required energy savings
- vert. installation of panels to max. format of 50 x 135 cm
- Overhead thanks to safe clamp fastening

Vertical, overhead

Horizontal, vertical, offset formation, overhead

Fastening level:

- Skeleton constructions, e.g. studded partition walls, sandwich panels
- Solid wall constructions, e.g. masonry, concrete

Fastening level:

- Skeleton constructions, e.g. studded partition walls, sandwich panels
- Solid wall constructions, e.g. masonry, concrete

- K20 Omega profiles mounted on vert. supporting structure
- Exact alignment of the horiz. joints using OmegaS profiles
- Safe fastening thanks to securing bracket
- Very fast assembly of panels
- Easy to replace or subsequently install individual panels

- Easy fastening with well-conceived clamp system
- Flexible fastening as each hole in the panel can be used
- Slight "pulling" or "pushing" of the grid is possible
- Easy to replace or subsequently install individual panels

Verification of applicability by an expert opinion analogue to the abZ Z-33.1-1175

Z-33.1-1175

Omega profiles, joint profiles, joint spacers, securing brackets, OmegaS supporting profile, fastening elements (screws or rivets)

Clamps, joint profile, fastening elements (rivets), joint tape

KERAION®

Quadro clasp

Quadro panel supporting profile

K8 clamp fastening

- Wall connections (bracket or strut) can be used to achieve thermal and static requirements
- Used to achieve the required energy savings
- Panels can be arranged in offset formation
- Lightweight panels
- Non-visible fastening

- Wall connections (bracket or strut) can be used to achieve thermal and static requirements
- Used to achieve the required energy savings
- Lightweight panels
- Panel format to 120 x 120 cm
- Non-visible fastening

- Wall connections (bracket or strut) can be used to achieve thermal and static requirements
- Used to achieve the required energy savings
- Lightweight panels
- Can be mounted on metal and wooden substructures

Non-visible fastening, formats to 60 x 90 cm

Non-visible fastening, formats to 120 x 120 cm

Visible fastening with stainless steel clamps (possibility of powder-coated lips), formats of up to 90 x 90 cm and 60 x 120 cm

Fastening level:

- Skeleton constructions, e.g. studded partition walls, sandwich panels
- Solid wall constructions, e.g. masonry, concrete

Fastening level:

- Skeleton constructions, e.g. studded partition walls, sandwich panels
- Solid wall constructions, e.g. masonry, concrete

Fastening level:

- Skeleton constructions, e.g. studded partition walls, sandwich panels
- Solid wall constructions, e.g. masonry, concrete

Fastening elements can be attached immediately to the pre-assembled Quadro points, low panel weight

Fastening elements can be attached immediately to the pre-assembled Quadro points, low panel weight

Tried-and-tested panel assembly, low weight, can be cut on site using basic tools (glass cutter)

Z-10.3-725

Z-10.3-724

Z-10.3-776

Rubber washers, self-locking stainless steel nuts

Rubber washers, self-locking stainless steel nuts

K8 clamps, foamed pieces, joint tape, fastening elements (rivets)

From professionals for professionals: the In-House Planning Department

Facade design is a complex challenge which besides aesthetic aspects also raises many technical and physical questions – in addition to the unavoidable bureaucracy. The In-House Planning Department of AGROB BUCHTAL, which was already established more than 60 years ago, offers professional support, so that architects can exclusively concentrate on their creative ideas. As AGROB BUCHTAL supplies high-quality products and competent services, planners and architects using the products can benefit from the know-how of a committed team of qualified technicians, engineers, designers and color experts, which ensure a quick

and problem-free realization of individual concepts. This also includes the concrete advice regarding application techniques, upon request on location. In addition to their advisory capacity, these experts also carry out routine tasks, which would only be disturbing at the development of architectural visions. They include laying plans, determinations of quantities, detailed estimates and also the preparation of texts for bidding purposes or the specific support at the application for sustainability certificates such as LEED, BREEAM or DGNB.

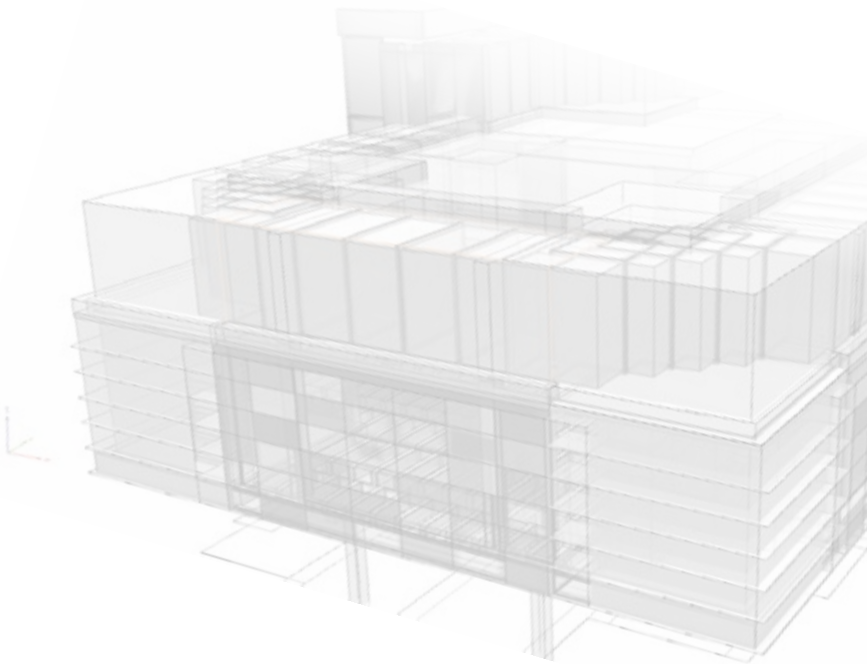
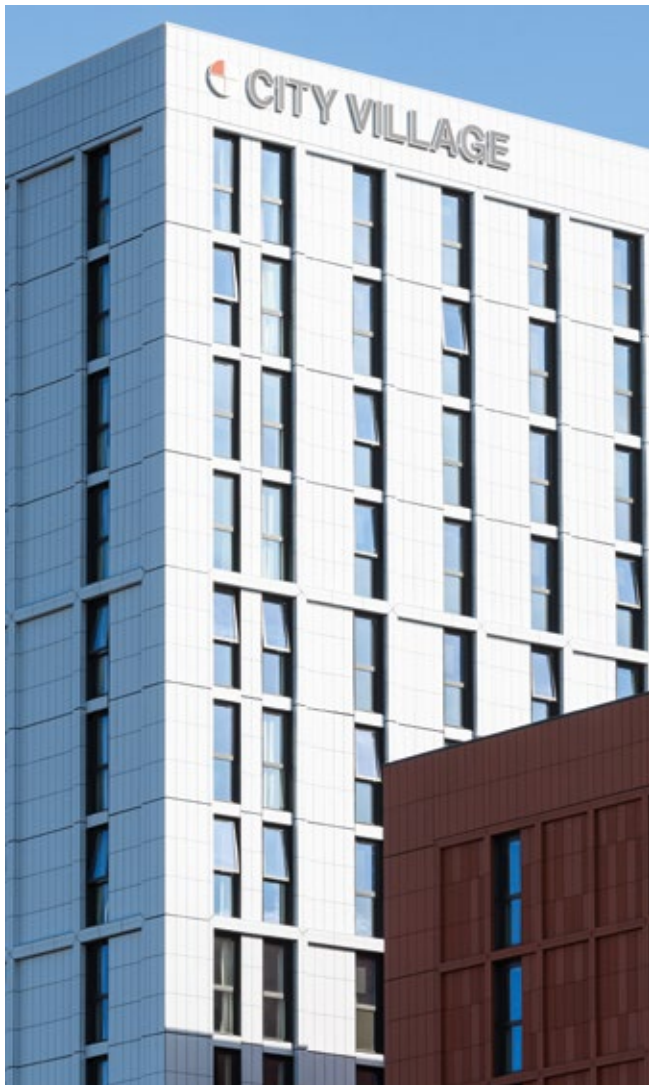

60 years
In-House Planning Department
AGROB BUCHTAL



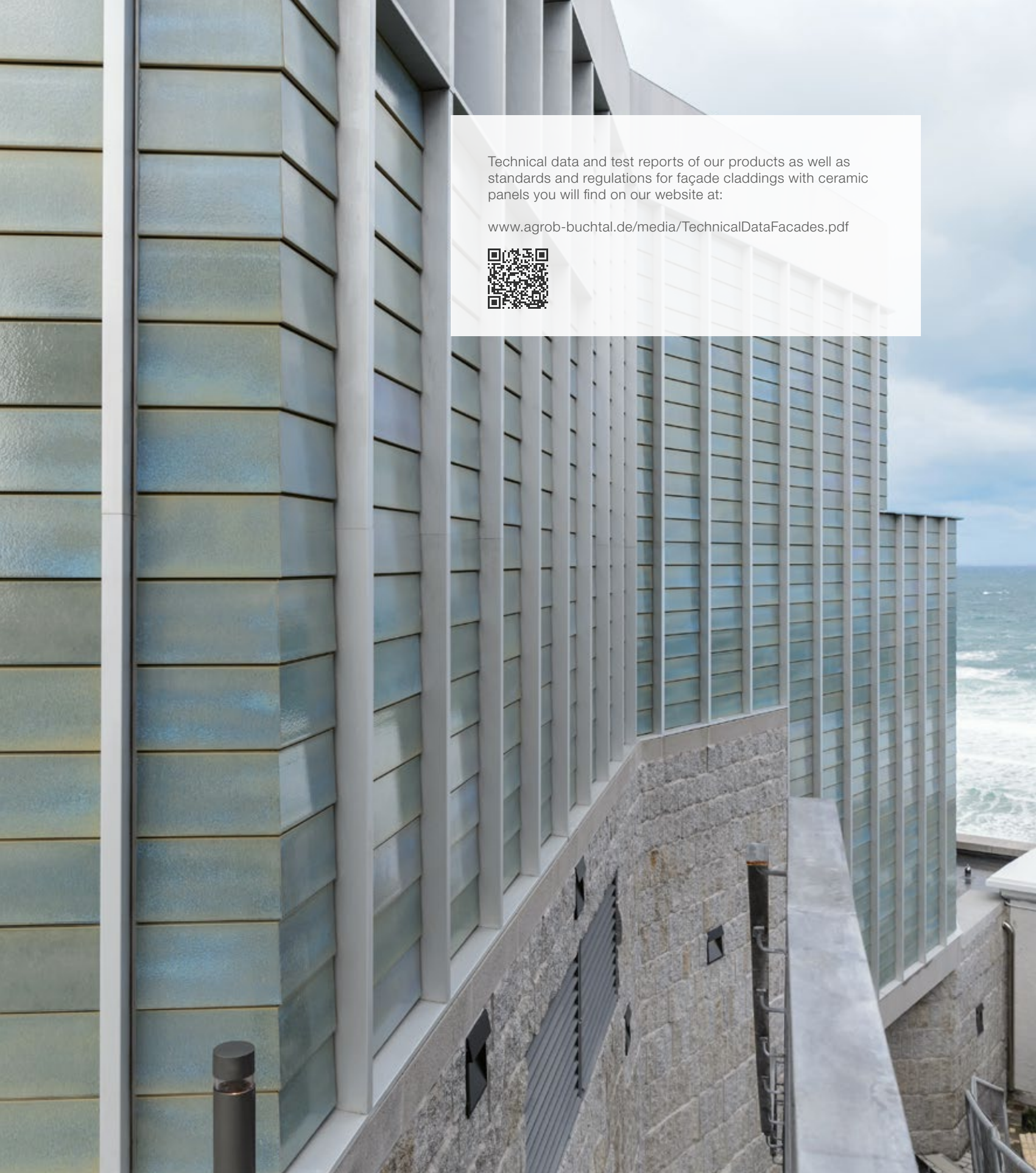

Technical data and test reports of our products as well as standards and regulations for façade claddings with ceramic panels you will find on our website at:

www.agrob-buchta.de/media/TechnicalDataFacades.pdf



AGROB BUCHTAL GmbH
Buchtal 1
D-92521 Schwarzenfeld
Phone: +49 (0) 94 35-391-0
Fax: +49 (0) 94 35-391-34 52
E-Mail: agrob-buchtal@deutsche-steinzeug.de
Internet: www.agrob-buchtal.de

You will find contact names for
other countries on the internet at:

www.agrob-buchtal.de

www.assenmacher.net

valid as of January 1, 2018, subject to modifications



In collaboration with
the Industrieverband
Keramische Fliesen +
Platten e.V., we support
the EPD range of Institut
Bauen und Umwelt e.V.,
for the purpose of
sustainable building.



The publisher assumes no liability for typographical errors. Color deviations
to the original products may occur during the printing process.