



castano

PRODUCT CATALOGUE



castanobathroomsandkitchens



castanobathroomsandkitchens



Castano Bathrooms and Kitchens

T | 1300 856 887 E | sales@castano.com.au W | www.castano.com.au

VICTORIA | SA | TAS

50 Bardia Avenue
Seaford VIC 3198

Table of Contents

1	Baths	
	Free Standing Baths With Ergonomic Backrests	5
	Wall Faced Freestanding Baths	6
	Inset & Freestanding Baths	7
	Matte White Freestanding Baths	8
2	Sinks & Laundry	
	Calabria 1.5mm Sinks	11
	Accessories	13
	Lirio Sinks	14
	Turin Sinks	15
	Panaro Sinks	16
	Pressed Undermount Sinks	17
	Comiso Sinks	18
	Utility Sinks	19
	Laundry	21
	Stainless Steel Kitchen Tapware	23
3	Basins	
	Solid Surface Basins	27
	Wall Hung/Counter Solid Surface Basin	29
	Premium Glass Basins	30
	Matte Ceramic Basins	32
	Alternative Ceramic Basins	37
	Drop in/Undermount Basins	39
	Semi Inset Ceramic Basins	40
	Semi Inset With Tap Landing Ceramic Basins	41
	Semi Recessed & Vessel Ceramic Basins	42
	Wall Hung Basins	43
	Above Counter Ceramic Basins	44
	Wastes for Basins	48
4	Toilets	
	Toilets	51
	Toilet & Accessories	53
5	Tapware, Showers, Accessories & Wastes	
	Capri Chrome 35mm	59
	Capri Black 35mm	61
	Capri Tapware Chrome 40mm	62
	Milan Chrome	64
	Milan CARE Chrome	69
	Milan Black	70
	Milan CARE Black	74
	Milan Brushed Nickel	75
	Milan Gun Metal	78
	Siera Chrome	81
	Siera Black	83
	Siera Brushed Nickel	85
	Siera Gun Metal	87
	Elba Chrome	89
	Elba Black	92
	Positano Chrome	95
	Positano Black	97
	Stainless Steel Kitchen Tapware	99
6	Accessories & Wastes	
	Capri Chrome Accessories	103
	Capri Black Accessories	105
	Capri Brushed Nickel Accessories	107
	Capri Gun Metal Accessories	108
	Elba Chrome Accessories	109
	Elba Black Accessories	110
	Waste for Vanities, Basins	111
	Ceramic Wastes	112
	Australian Made Floor Grates	113
7	Vanities & Wall Cabinets	
	Tiram	116
	Vienna Stain White	118
	Vienna Wall Hung Satin White	120
	Catani Wall Hung Satin White	122
	Janine Full Depth	124
	Janine Ensuite	126
	Maali	128
	Florence Wall Cabinets	130
	Vitreous China Tops	132
	Universal Bowl Tops	133
	Solid Surface Benchtops	134
	Stone 20mm Benchtops	135
	Vanity Accessories & Waste Options	136
8	Product Warranty	139

FREESTANDING AND INSET BATHS



100% LUCITE CROSSLINKED ACRYLIC SHEET

Castano Baths are manufactured from 100% Lucite Cross Linked Acrylic Sheet, the most durable and resistant acrylic sheet available which provides a High UV Resistance and High Chemical Resistance. The story of Lucite Cross Linked Acrylic Sheet is that no other acrylic sheet is made the same way, due to the bond of cross linked technology that links one polymer chain to another creating a net structure within the acrylic sheet, providing a strong, durable acrylic sheet. When it comes to manufacturing baths, baths can be all sorts of shapes and sizes with tight radius internal corners.

100% Lucite Cross Linked Acrylic Sheet can be thermoformed at one of the lowest temperatures, providing on average a thickness of 3mm of acrylic sheet throughout the shape of the bath with tight radius, ensuring no weak points during the manufacturing process. Lucite Cross-Linked Acrylic Sheet is generally thicker than most other acrylics used in the production of baths. Lucite is owned by Lucite International Ltd controlled by Mitsubishi Chemical LTD based in Japan.

Lucite Cross Linked Acrylic provides high resistance to hot water that is over 60 degrees which can provide stable colour. Cross-Linked Acrylic Sheet used on baths is a requirement to meet EU standards such as CSN EN 263 Sanitary Products.

Ensure your next bath is constructed from 100% Lucite Cross Linked Technology, backed by Castano's Australian Wide 25 Year Warranty. Do it right the first time with Lucite Cross Linked Acrylic. Anything Else Is A Comprise



Arese 1600 'Lucite' Freestanding Bath Slimline Moulded Backrest

- 1600L x 800W x 580H (255 litre capacity)
- 100% Lucite Cross Linked Acrylic Sheet
- Internal Depth 445mm, 8mm Slim Edge
- Ergonomic Back Rests On Each End
- Adjustable Legs on Robust Frame
- 25 Years Product Replacement Warranty
- 40mm Waste Required for ARE1600FB
- All overflow baths have over flow kits with pop-up waste installed

Code	R.R.P (inc GST)
ARE1600FB (no overflow kit)	\$2499
ARE1600FB-OF (chrome overflow kit)	\$2649
ARE1600FB-OFWH (white overflow kit)	\$2649
ARE1600FB-OFBL (Black overflow kit)	\$2649
ARE1600FB-OFNI (brushed nickel overflow kit)	\$2649



Corsica 1600 'Lucite' Freestanding Bath Slimline Moulded Backrest

- 1600L x 800W x 720H (240 litre capacity)
- 100% Lucite Cross Linked Acrylic Sheet
- Ergonomic Backrest
- 8mm Slim Edge
- Adjustable Legs on Robust Frame
- 25 Years Product Replacement Warranty
- 40mm Waste Required for COR1600FB
- All overflow baths have over flow kits with pop-up waste installed

Code	R.R.P (inc GST)
COR1600FB (no overflow kit)	\$2599
COR1600FB-OF (chrome overflow kit)	\$2799
COR1600FB-OFWH (white overflow kit)	\$2799
COR1600FB-OFBL (black overflow kit)	\$2799
COR1600FB-OFNI (brushed nickel overflow kit)	\$2799



Pop Up Bath Basket Pull Out Waste 40mm

- Not available for POS1600FB-OF, COR1600FB-OF (overflow & pop-up waste kit already installed)
- Chrome Plated/Matt Black/Brushed Nickel
- Available for all other baths
- 7 year product replacement only
- Pull out basket waste hair catcher

Code	R.R.P (inc GST)
POBBAS40C	\$48
POBBAS40-BL	\$79
POBBAS40-NI	\$89



ARESE



CORSICA 1600



Positano 1400/1600 'Lucite' LH Corner bath

- 1400L x 750W x 580H (275 litre capacity)
- 1600L x 750W x 580H (325 litre capacity)
- 100% Lucite Cross Linked Acrylic Sheet
- Ergonomic Backrest on both ends of the bath
- 8mm Slim Front Edge
- Adjustable Legs on Robust Frame
- 25 Year Product Replacement Warranty
- 40mm Waste Required

- Not Suitable for shower bath for Positano 1600 and 1400 Corner Baths

Code	R.R.P (inc GST)
POS1400CB-LH	\$2199
POS1600CB-LH	\$2499



Positano 1400/1600 'Lucite' RH Corner Bath

- 1400L x 750W x 580H (275 litre capacity)
- 1600L x 750W x 580H (325 litre capacity)
- 100% Lucite Cross Linked Acrylic Sheet
- Ergonomic Backrest on both ends of the bath
- 8mm Slim Front Edge
- Adjustable Legs on Robust Frame
- 25 Year Product Replacement Warranty
- 40mm Waste Required

- Not Suitable for shower bath for Positano 1600 and 1400 Corner Baths

Code	R.R.P (inc GST)
POS1400CB-RH	\$2199
POS1600CB-RH	\$2499



Positano 1660 'Lucite' Back To Wall Bath

- 1660L x 800W x 580H (293 litre capacity)
- 100% Lucite Cross Linked Acrylic Sheet
- 20mm Slim Front Edge design
- Adjustable Legs on Robust Frame
- 25 Year Product Replacement Warranty
- 40mm Waste Required

Code	R.R.P (inc GST)
POSBTW1660FB	\$2499



Pop Up Bath Basket Pull Out Waste 40mm

- Not available for POS1600FB-OF, COR1600FB-OF (overflow & pop-up waste kit already installed)
- Chrome plated or Matt Black solid brass
- 7 year product replacement only
- Pull out basket waste hair catcher
- Available for all other baths

Code	R.R.P (inc GST)
POBBAS40C	\$48
POBBAS40-BL	\$79
POBBAS40-NI	\$89



LUCITE[®]
The source of inspiration

CROSS LINKED



POSITANO CORNER LH



POSITANO CORNER RH



POSITANO 1660 BACK TO WALL



Positano 1400/1600/1800 'Lucite' Freestanding Bath

- 100% Lucite Cross Linked Acrylic Sheet
- Adjustable legs on a robust frame for easy installation
- 1400L x 800W x 580H (238 litre capacity)
- 1600L x 800W x 580H (303 litre capacity)
- 1800L x 800W x 580H (360 litre capacity)
- 25 Years Product Replacement Warranty
- 20mm wide edge
- 40mm waste required

Code	R.R.P (inc GST)
POS1400FB	\$2199
POS1600FB	\$2499
POS1800FB	\$2699



Sorriso 1670 'Lucite' Freestanding Bath

- 1670L x 790W x 660H (256 litre capacity)
- 100% Lucite Cross Linked Acrylic Sheet
- 25 Years Product Replacement Warranty
- Adjustable legs on a robust frame for easy installation
- 20mm wide edge
- 40mm waste required

Code	R.R.P (inc GST)
SOR167FB	\$2499



Velino 1675 'Lucite' Freestanding Bath LH Shelf

- 1676L x 764W x 600H (320 litre capacity)
- Manufactured from 100% Lucite Crosslinked Acrylic Sheet
- Robust Frame with Adjustable Feet Included
- Left Hand Shelf on back of bath to accomodate bathing products
- Colour will not fade from water cycling over 60 degrees.
- 25 Years Product Replacement Warranty
- High UV and Chemical Resistance
- Gloss White Finish
- 40mm waste required

Code	R.R.P (inc GST)
VEL1676FB-LH	\$2599



Monterosso 'Lucite' 1525/1675/1800 Drop in Bath

- 1525L x 765W x 420H (237 litre capacity)
- 1675L x 765W x 420H (267 litre capacity)
- 1800L x 800W x 470H (297 litre capacity)
- Able to fit shower screen panel to create shower bath
- 100% Lucite Cross Linked Acrylic Sheet
- 30mm wide edge
- 25 Years Product Replacement Warranty
- 40mm waste required
- 4 Sided Tiling Lip (5mm thick)

Code	R.R.P (inc GST)
MON1525B	\$439
MON1675B	\$479
MON1800B	\$619



VELINO 1675



POSITANO STANDARD



SORRISO 1670



MONTEROSSO 1525/1675/1800



Positano 1400/1600/1800 Matte White Freestanding Bath

- Cross linked sanitary grade acrylic sheet
- Matte acrylic inside, Matte 2-pac outside
- Adjustable legs on a robust frame
- 1400L x 800W x 580H (238 litre capacity)
- 1600L x 800W x 580H (303 litre capacity)
- 1800L x 800W x 580H (360 litre capacity)
- 10 Years Product Replacement Warranty

- 20mm wide edge
- 40mm waste required

Code	R.R.P (inc GST)
POS1400FB-MW	\$2199
POS1600FB-MW	\$2499
POS1800FB-MW	\$2699



Positano 1400/1600 Corner Bath LH Bath Slimine Matte White

- 1400L x 750W x 580H (275 litre capacity)
- 1600L x 750W x 580H (325 litre capacity)
- Cross linked sanitary grade acrylic sheet
- Ergonomic Backrest on both ends of the bath
- Matte acrylic inside, Matte 2-pac outside
- 8mm Slim Front Edge
- Adjustable legs on a robust frame
- 10 Years Product Replacement Warranty

- 40mm Waste Required
- Not Suitable for shower bath for Positano 1600 and 1400 Corner Baths

Code	R.R.P (inc GST)
POS1400CB-LH-MW	\$2499
POS1600CB-LH-MW	\$2499



Positano 1400/1600 Corner Bath RH Bath Slimine Matte White

- 1400L x 750W x 580H (275 litre capacity)
- 1600L x 750W x 580H (325 litre capacity)
- Cross linked sanitary grade acrylic sheet
- Ergonomic Backrest on both ends of the bath
- Matte acrylic inside, Matte 2-pac outside
- 8mm Slim Front Edge
- Adjustable legs on a robust frame
- 10 Years Product Replacement Warranty

- 40mm Waste Required
- Not Suitable for shower bath for Positano 1600 and 1400 Corner Baths

Code	R.R.P (inc GST)
POS1400CB-RH-MW	\$2499
POS1600CB-RH-MW	\$2499



Positano 1660 Back To Bath Matte White

- 1660L x 800W x 580H (293 litre capacity)
- Cross linked sanitary grade acrylic sheet
- Matte acrylic inside, Matte 2-pac outside
- 8mm Slim Front Edge
- 20mm Slim Front Edge design
- Adjustable Legs on Robust Frame
- 10 Years Product Replacement Warranty
- 40mm Waste Required

Code	R.R.P (inc GST)
POSBTW1660FB-MW	\$2499



POSITANO STANDARD



POSITANO CORNER LH



POSITANO CORNER RH



POSITANO 1660 BACK TO WALL

SINKS AND LAUNDRY





Calabria 300 Single Bowl Sink

- 300L x 450W x 250D - 25 litre capacity
- Underbowl protective coating
- 1.5 mm handmade heavy duty sink
- 304 Stainless Steel
- Undermount or overmount
- Waste strainer included
- Smooth round edges R10
- 25 year product replacement warranty

Code	R.R.P (inc GST)
CBM21	\$425



Calabria 450 Single Bowl Sink

- 450L x 450W x 250D - 40 litre capacity
- Underbowl protective coating
- 1.5 mm hand made heavy duty sink
- 304 Stainless Steel
- Undermount or overmount
- Waste strainer included
- Smooth round edges R10
- 25 year product replacement warranty

Code	R.R.P (inc GST)
CBM02	\$459



Calabria 510 Single Bowl Sink

- 510L x 450W x 250D - 46 litre capacity
- Underbowl protective coating
- 1.5 mm handmade heavy duty sink
- 304 Stainless Steel
- Undermount or overmount
- Waste strainer included
- Smooth round edges R10
- 25 year product replacement warranty

Code	R.R.P (inc GST)
CBM03	\$505



Calabria 700 Single Bowl Sink

- 700L x 450W x 250D - 60 litre capacity
- Underbowl protective coating
- 1.5 mm handmade heavy duty sink
- 304 Stainless Steel
- Undermount or overmount
- Waste strainer included
- Smooth round edges R10
- 25 year product replacement warranty

Code	R.R.P (inc GST)
CBM05	\$595



Calabria 810 Single Bowl Sink

- 810L x 450W x 250D - 76 litre capacity
- Underbowl protective coating
- 1.5 mm hand made heavy duty sink
- 304 Stainless Steel
- Undermount or overmount
- Waste strainer included
- Smooth round edges R10
- 25 year product replacement warranty

Code	R.R.P (inc GST)
CBM07	\$725



Calabria 950 Single Bowl Sink & Drainer

- 950L x 450W x 205D - 45 litre capacity
- Underbowl protective coating
- 1.5 mm hand made heavy duty sink
- 304 Stainless Steel
- Undermount or overmount
- Waste strainer included
- Smooth round edges R10
- 25 year product replacement warranty

Code	R.R.P (inc GST)
CBM09	\$835



Calabria 725 1 & 1/2 Bowl Sink

- 725L x 450W x 205D - 53 litre capacity
- Underbowl protective coating
- 1.5 mm handmade heavy duty sink
- 304 Stainless Steel
- Undermount or overmount
- Waste strainer included
- Smooth round edges R10
- 25 year product replacement warranty

Code	R.R.P (inc GST)
CBM11	\$805



Calabria 770 Double Bowl Sink

- 770L x 450W x 205D - 57 litre capacity (CBM13) - 61 litre capacity (CBM13D)
- Underbowl protective coating
- 770L x 450W x 250D (CBM13D)
- 1.5 mm handmade heavy duty sink
- 304 Stainless Steel
- Undermount or overmount
- Waste strainer included
- Smooth round edges R10
- 25 year product replacement warranty

Code	R.R.P (inc GST)
CBM13	\$839
CBM13D	\$899



Calabria 825 1 & 3/4 Bowl Sink

- 825L x 450W x 205D - 61 litre capacity
- Underbowl protective coating
- 1.5 mm hand made heavy duty sink
- 304 Stainless Steel
- Undermount or overmount
- Waste strainer included
- Smooth round edges R10
- 25 year product replacement warranty

Code	R.R.P (inc GST)
CBM15	\$865



Calabria 1080 1 & 3/4 Bowl & Drainer

- 1080L x 450W x 205D - 50 litre capacity
- Underbowl protective coating
- 1.5 mm hand made heavy duty sink
- 304 Stainless Steel
- Undermount or overmount
- Waste strainer included
- Smooth round edges R10
- 25 year product replacement warranty

Code	R.R.P (inc GST)
CBM17	\$980



Calabria 1125 Double Bowl & Drainer

- 1125L x 450W x 205D - 57 litre capacity
- Underbowl protective coating
- 1.5 mm hand made heavy duty sink
- 304 Stainless Steel
- Undermount or overmount
- Waste strainer included
- Smooth round edges R10
- 25 year product replacement warranty

Code	R.R.P (inc GST)
CBM19	\$1120



Calabria Chopping Board/Bamboo Chopping Board

Calabria Chopping Board

- 435 x 300 x 20
- Great accessory to the Calabria sinks
- Sits flush inside all models or inside stone. Not suitable for dishwasher

Panaro Bamboo Chopping Board

- 425 x 260
- Suits Panaro 800, 1080
- Not suitable for dishwasher

Code	R.R.P (inc GST)
SSORTACB	\$79
SSPANBCB	\$79



Calabria Roll Mat

- 400 x 430
- Great accessory to the Calabria sinks
- Sits on top of sink line or on top of stone
- 1 year warranty

Code	R.R.P (inc GST)
SSORTARM	\$87



Calabria Steel Colander

- 426 x 231 x 91
- Great accessory to the Calabria sinks
- Sits flush inside all models or inside stone
- 1 year warranty

Code	R.R.P (inc GST)
SSORTAWB	\$104

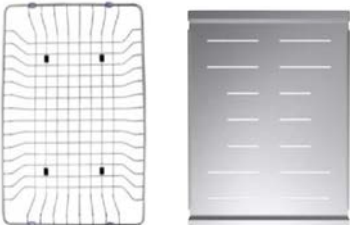

Calabria Dishrack / Calabria Dish Drainer Tray

- 425 x 270 x 120 (Dishrack)
- Great accessory to the Calabria sinks
- Sits flush inside all models
- 1 year warranty
- 440 x 322 x 15 (Drainer Tray)
- Great accessory to the Calabria sinks
- Sits flush inside all models or inside stone
- 1 year warranty

Code	R.R.P (inc GST)
DR425270120 (Dishrack)	\$89
SSORTADT5037L (Tray)	\$104



Lirio Single Bowl Sink

- 450L x 390W x 200D
- 1mm hand made sink
- SS304 Brushed Stainless Steel (1.0 Thickness)
- 90mm Basket Waste
- Top Mount or Undermount
- 10 year product replacement
- 1 year labour

Code	R.R.P (inc GST)
SSLIRSB450	\$315



Lirio 1 & 1/2 Bowl Sink

- 670L x 450W x 200D
- 1mm hand made sink
- SS304 Brushed Stainless Steel (1.0 Thickness)
- Basket Waste/Clips/Sealing Tape Included
- 90mm Basket Waste
- Top Mount or Undermount
- 10 year product replacement
- 1 year labour

Code	R.R.P (inc GST)
SSLIRBH670	\$629



Lirio Double Bowl Sink

- 760L x 450W x 200D
- 1mm hand made sink
- SS304 Brushed Stainless Steel (1.0 Thickness)
- 90mm Basket Waste
- Top Mount or Undermount
- 10 year product replacement
- 1 year labour

Code	R.R.P (inc GST)
SSLIRDB760	\$629



Lirio Care Single Bowl

- 480L x 460W x 145D
- 1mm hand made sink
- SS304 Brushed Stainless Steel (1.0 Thickness)
- 90mm Basket Waste
- Topmount
- Underbowl Heat Pad included
- 10 year product replacement
- 1 year labour

Code	R.R.P (inc GST)
SSLIRSB480	\$735



Lirio Care Single Bowl and Drainer

- 800L x 460W x 145D
- 1mm hand made sink
- SS304 Brushed Stainless Steel (1.0 Thickness)
- 90mm Basket Waste
- Topmount
- Underbowl Heat Pad included
- 10 year product replacement
- 1 year labour

Code	R.R.P (inc GST)
SSLIRSB800	\$839



Turin 780 Single Bowl Sink with Drainer

- Single Sink
- 780L x 480W x 180D
- Available RH or LH Bowl
- SS304 (0.9 Thickness)
- Silk Finish
- Basket Waste/Clips/Sealing Tape Included
- 10 year product replacement
- 1 year labour

Code	R.R.P (inc GST)
TUSS780LH	\$230
TUSS780RH	\$230



Turin 980 1 1/2 Bowl Sink with Drainer

- 1 1/2 Bowl Sink
- 980L x 480W x 180D
- Available RH or LH Bowl
- SS304 (0.9 Thickness)
- Silk Finish
- Basket Waste/Clips/Sealing Tape Included
- 10 year product replacement
- 1 year labour

Code	R.R.P (inc GST)
TUSS980LH	\$279
TUSS980RH	\$279



Turin 1080 1 3/4 Bowl Sink with Drainer

- 1 3/4 Bowl Sink
- 1080L x 480W x 180D
- Available RH or LH Bowl
- SS304 (0.9 Thickness)
- Silk Finish
- Basket Waste/Clips/Sealing Tape Included
- 10 year product replacement
- 1 year labour

Code	R.R.P (inc GST)
TUSS1080LH	\$295
TUSS1080RH	\$295



Turin 1180 Double Bowl Sink with Drainer

- Double Bowl Sink
- 1180L x 480 W x 180D
- Available RH or LH Bowl
- SS304 (0.9 Thickness)
- Silk Finish
- Basket Waste/Clips/Sealing Tape Included
- 10 year product replacement
- 1 year labour

Code	R.R.P (inc GST)
TUSS1180LH	\$345
TUSS1180RH	\$345



Panaro 800 Single Bowl Sink With Drainer

- Single Sink
- 800L x 480W x 178D
- SS304 (0.8 Thickness)
- Available RH or LH Bowl
- Satin Finish
- Basket Waste/Clips/Sealing Tape Included
- 10 year product replacement
- 1 year labour

Code	R.R.P (inc GST)
SSPAN800LH	\$230
SSPAN800RH	\$230



Panaro 1080 1 & ¾ Bowl Sink With Drainer

- 1 ¾ Bowl Sink
- 1080L x 480W x 178D
- Available RH or LH Bowl
- SS304 (0.8 Thickness)
- Satin Finish
- Basket Waste/Clips/Sealing Tape Included
- 10 year product replacement
- 1 year labour

Code	R.R.P (inc GST)
SSPAN1080LH	\$295
SSPAN1080RH	\$295



Lyon Single Undermount Sink

- Single Undermount Sink
- 450L x 395W x 180D
- SS304 (0.9 Thickness)
- Silk Finish
- Basket Waste/Clips/Sealing Tape Included
- Undermount installation only
- 10 year product replacement
- 1 year labour

Code	R.R.P (inc GST)
SSLYON1023A	\$205



Solanto Single Undermount Sink

- 411L x 461W x 228D
- 1mm Thickness
- Satin Finish
- Basket Waste/Clips/Sealing Tape Included
- Undermount installation only
- 10 year product replacement
- 1 year labour

Code	R.R.P (inc GST)
SSSOLSB411	\$205



Mezzo 1 1/2 Bowl Undermount Sink

- 1 1/2 Bowl Undermount Sink
- 670L x 450W x 180D
- SS304 (0.7 Thickness)
- Silk Finish
- Basket Waste/Clips/Sealing Tape Included
- Undermount installation only
- 10 year product replacement
- 1 year labour

Code	R.R.P (inc GST)
SSMEZ2131A	\$295



Solanto Double Undermount Sink

- Double Undermount Sink
- 794L x 457W x 203D
- 1mm Thickness
- Satin Finish
- Basket Waste/Clips/Sealing Tape Included
- Undermount installation only
- 10 year product replacement
- 1 year labour

Code	R.R.P (inc GST)
SSSOLDB794	\$349



Granado Double Undermount Sink

- Double Undermount Sink
- 785L x 450W x 180D
- SS304 (0.9 Thickness)
- Silk Finish
- Basket Waste/Clips/Sealing Tape Included
- Undermount installation only
- 10 year product replacement
- 1 year labour

Code	R.R.P (inc GST)
SSGRA0028A	\$349



Comiso Double Bowl Sink Black Quartz

- Overall Size 813mm x 457mm x 247mm
- Manufactured from German sourced Quartz Material
- Top Mount or Undermount Installation
- Dual Stainless Steel Basket Wastes
- 15 year product replacement warranty
- 1 year labour warranty
- 75% Quartz Composition, 25% Resin

Code	R.R.P (inc GST)
COMDBS813	\$785



Comiso Large Single Bowl Sink Black Quartz

- Overall Size 530mm x 460mm x 215mm
- Manufactured from German sourced Quartz Material
- Top Mount or Undermount Installation
- Stainless Steel Basket Waste
- 15 year product replacement warrant
- 1 year labour warranty
- 75% Quartz Composition, 25% Resin

Code	R.R.P (inc GST)
COMSBL530	\$692



Comiso Small Single Bowl Sink Black Quartz

- Overall Size 430mm x 460mm x 215mm
- Manufactured from German sourced Quartz Material
- Top Mount or Undermount Installation
- Stainless Steel Basket Waste
- 15 year product replacement warranty
- 1 year labour warranty
- 75% Quartz Composition, 25% Resin

Code	R.R.P (inc GST)
COMSBS430	\$659



Lavello Utility Sink 25lt with Tap Landing

- Overall Size 350L x 500W x 240D - Bowl Size 300L x 400W x 230D
- Underbowl protective coating
- Top mounted
- 1.2mm handmade heavy duty sink
- 304 Stainless Steel
- Smooth round edges R10
- Basket Waste/Clips
- 10 year product replacement warranty

Code	R.R.P (inc GST)
SSLAVTL20	\$409



Lavello Utility Sink 35lt with Tap Landing

- Overall Size 450L x 500W x 240D - Bowl Size 400L x 400W x 230D
- Underbowl protective coating
- Top mounted
- 1.2mm handmade heavy duty
- 304 Stainless Steel
- Smooth round edges R10
- Basket Waste/Clips
- 10 year product replacement warranty

Code	R.R.P (inc GST)
SSLAVTL30	\$429



Lavello Utility Sink 45lt with Tap Landing

- Overall Size 550L x 500W x 240D - Bowl Size 500L x 400W x 230D
- Underbowl protective coating
- Top mounted
- 1.2mm handmade heavy duty
- 304 Stainless Steel
- Smooth round edges R10
- Basket Waste/Clips
- 10 year product replacement warranty

Code	R.R.P (inc GST)
SSLAVTL40	\$457

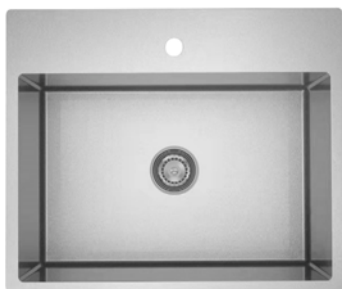

Lavello Utility Sink 70lt with Tap Landing

- Overall Size 650L x 500W x 310D - Bowl Size 600L x 400W x 300D
- Underbowl protective coating
- Top mounted
- 1.2mm handmade heavy duty
- 304 Stainless Steel
- Smooth round edges R10
- Basket Waste/Clips
- 10 year product replacement warranty

Code	R.R.P (inc GST)
SSLAVTL70	\$575



Lavello Utility Sink 25lt with Overflow

- Overall Size 350L x 450W x 240D- Bowl Size 300L x 400W x 230D
- Underbowl protective coating
- 1.2mm handmade heavy duty sink
- Undermount or Topmount Installation
- Watermarked Basket Waste and overflow included
- 304 Stainless Steel
- Basket Waste/Clips
- 10 year product replacement warranty

Code	R.R.P (inc GST)
SSLAVW020	\$436



Lavello Utility Sink 35lt with Overflow

- Overall Size 450L x 450W x 240D -Bowl Size 400L x 400W x 230D
- Underbowl protective coating
- 1.2 mm handmade heavy duty
- Undermount or Topmount Installation
- Watermarked Basket Waste and overflow included
- 304 Stainless Steel
- Basket Waste/Clips
- 10 year product replacement warranty

Code	R.R.P (inc GST)
SSLAVW030	\$449



Lavello Utility Sink 45lt with Overflow

- Overall Size 550L x 450W x 240D- Bowl Size 500L x 400W x 230D
- Underbowl protective coating
- 1.2 mm handmade heavy duty
- Undermount or Topmount Installation
- Watermarked Basket Waste and overflow included
- 304 Stainless Steel
- Basket Waste/Clips
- 10 year product replacement warranty

Code	R.R.P (inc GST)
SSLAVW040	\$505

Stainless Steel

A common question is which stainless steel is right for my project, Type 304 or Type 301 or 302? While these alloys are stainless steel and very similar in content, there are some key differences, the percentages of chromium, nickel and carbon. Type 301 or 302 was developed to be a lower-cost alternative to Type 304. In order to achieve the desired lower cost, the alloy's formula was specifically developed to include less of the more expensive elements nickel and chromium and higher percentages relatively of inexpensive carbon.

Carbon is an alloying element in all types of steel as it makes brittle iron malleable and ductile. Its percentage in an alloy determines a great deal about workability, hardness and performance properties. Type 304 contains just 0.08% max carbon, it's considered the industry standard for food and beverage processing equipment.

Chromium gives the stainless steel its luster and durability. Type 304 has 18% minimum chromium content, this provides corrosion and oxidation resistance and helps to maintain the beautiful luster as if it were a new sink. Type 301 and 302 have only 16% and are more susceptible to corrosion and oxidation and looking dull over the life of the sink.

Nickel gives stainless steel hardness and strength. Type 304 with 12% nickel helps it take the abuse in all types of environments. Types 301 or 302 have only 6.0% nickel creating a greater chance for the sink to show wear.

HYGIENE

The easy cleaning ability of stainless makes it the first choice for strict hygiene conditions, such as hospitals, kitchens and other food processing facilities.

GREEN

All manufacturing process create a carbon foot print, the amount of carbon emitted during the production process.

In the case of stainless steel, the emission is 0.04% than that of regular. All Castano kitchen sinks are constructed using the finest quality. Type 304 stainless steel.

It's 100% Green and 100% recyclable.



Lagos 45L Inset Bowl with Double Bypass

- 45L Inset Bowl
- 630L x 470W x 230D
- Single By-Pass Kit/Basket Waste/Clips/Sealing Tape Included
- SS304 (0.8 Thickness)
- Silk Finish
- 10 year product replacement warranty

Code	R.R.P (inc GST)
SSLAGOS1010C	\$220



Catena 45L Laundry Bowl With Bypass Kit

- 600L x 500W x 250D
- SS304 (0.8 Thickness)
- Satin Finish
- Single By-Pass Kit/Basket Waste/Clips/Sealing Tape Included
- 10 year product replacement warranty

Code	R.R.P (inc GST)
SSCAT45L	\$220



Conza 32L Inset Bowl

- 455L x 555W x 220D
- SS304 (0.8 Thickness)
- Silk Finish
- Single By-Pass Kit/Basket Waste/Clips/Sealing Tape Included
- 10 year product replacement warranty

Code	R.R.P (inc GST)
SSCONZ32	\$220



Arno Laundry 42L Lucite Acrylic Utility Sink

- 600mm x 500mm x 250mm D
- Supplied with Australian Watermarked 90mm Basket Waste
- Manufactured from 100% Lucite Crosslinked Acrylic Sheet
- Very Durable, Chemical Resistant, UV Resistant
- Scratches can be removed with Wet and Dry Sand Paper and Car Polish
- Designed for Wall Mounted or Bench Mounted Tapware
- 25 Year Product Replacement Warranty
- Available in NTH or 1TH
- Gloss White Finish
- Fiberglass reinforced
- Will Not Rust
- Generous 240mm Internal Bowl Depth
- 42L Capacity

Code	R.R.P (inc GST)
ARNO42NTH	\$319
ARNO421TH	\$319



Arno Laundry 64L Lucite Acrylic Utility Sink

- 635mm x 560mm x 330mm D
- Supplied with Australian Watermarked 90mm Basket Waste
- Manufactured from 100% Lucite Crosslinked Acrylic Sheet
- Very Durable, Chemical Resistant, UV Resistant
- Scratches can be removed with Wet and Dry Sand Paper and Car Polish
- Designed for Wall Mounted or Bench Mounted Tapware
- 25 Year Product Replacement Warranty
- Available as NTH or 1TH
- Baby Bath
- Gloss White Finish
- Fiberglass reinforced
- Will Not Rust
- Generous 320mm Internal Bowl Depth
- 64L Capacity

Code	R.R.P (inc GST)
ARNO64NTH	\$419
ARNO641TH	\$419



Vasca 20L Fingerpull Laundry Cabinet

- 20L Vasca Laundry Cabinet
- Handmade sink
- White powder coated metal cabinet
- Cabinet 300L x 550W x 900H
- Classic Finger Pull Design
- Flexible By Pass Kit Included
- 10 year product replacement warranty

- 304 grade stainless 1.0m steel sink with 10mm radius
- Designer basket waste

Code	R.R.P (inc GST)
SSVAS20L	\$409



Vasca 35L Fingerpull Laundry Cabinet

- 35L Vasca Laundry Cabinet
- White powder coated metal cabinet
- Cabinet 394L x 570W x 900H
- Classic Finger Pull Design
- Flexible By Pass Kit Included
- 10 year product replacement warranty

- 304 grade stainless steel sink
- Designer basket waste
- Underbowl Protective Coating

Code	R.R.P (inc GST)
SSVAS35L	\$379



Vasca 45L Fingerpull Laundry Cabinet

- 45L Vasca Laundry Cabinet
- White powder coated metal cabinet
- Cabinet 600L x 500W x 900H
- Classic Finger Pull Design
- Flexible By Pass Kit Included
- 10 year product replacement warranty

- 304 grade stainless steel sink
- Designer basket waste
- Underbowl Protective Coating

Code	R.R.P (inc GST)
SSVAS45L	\$395



Belucci Sink Mixer with Flexi Hose Black Hose

- Manufactured from 304 Stainless Steel
- Brushed Stainless Steel Finish
- Great alternative to Brushed Nickel Brass construction tapware
- PEX Flexible Tails
- Lifetime Warranty Construction of the Tap Body
- Lead Free Tap Body
- 2 Function Pattern Spray Head
- Easy fix fixing kit
- 100mm extension thread (ideal for thicker substrates)
- WELS 5 stars 6.0L/min
- 15 year warranty on cartridge
- Labour 2 Year In House Warranty

Code	R.R.P (inc GST)
BELSISS	\$539



Valerno Pull Out Sink Mixer Brushed Stainless Steel

- Manufactured from 304 Stainless Steel
- Brushed Stainless Steel Finish
- Lead Free Tap Body
- 35mm Cold Start Cartridge Position
- 2 Function Pattern Spray Head
- Flexible Ball Joint Spray Head – Stainless Steel
- Great alternative to Brushed Nickel Brass construction tapware
- Lifetime Warranty Construction of the Tap Body
- Cartridge – 15 Year Product Replacement Warranty
- Finish – Lifetime Warranty
- Labour 2 Year In House Warranty
- WELS 5 Star 5.5L/Minl
- PEX Flexible Tails

Code	R.R.P (inc GST)
VALPOSSIS	\$505



Valerno Pull Out Sink Mixer Coal

- Manufactured from 304 Stainless Steel
- Finish - Black with Nano Coating
- Lead Free Tap Body
- 35mm Cold Start Cartridge Position
- 2 Function Pattern Spray Head
- Flexible Ball Joint Spray Head – Stainless Steel
- Finish Warranty 5 Years
- Lifetime Warranty Construction of the Tap Body
- Cartridge – 15 Year Product Replacement Warranty
- Labour 2 Year In House Warranty
- WELS 5 Star 5.5L/Minl
- PEX Flexible Tails

Code	R.R.P (inc GST)
VALPOSSIS-BL	\$619

BASINS





Positano Oval Solid Surface Basin Above Counter Snow

- 100% Solid Surface Material
- 505mm x 355mm x 110mm H
- Snow Finish
- 5 Year Product Replacement Warranty
- 1 Year Labour
- 32mm Non-Overflow Waste Not Included



Code	R.R.P (inc GST)
POSOVSSBS <small>(snow)</small>	\$575



Positano Oval Solid Surface Basin Above Counter Pebble

- 100% Solid Surface Material
- 505mm x 355mm x 110mm
- Pebble Finish
- 5 Year Product Replacement Warranty
- 1 Year Labour
- 32mm Non-Overflow Waste Not Included



Code	R.R.P (inc GST)
POSOVSSBP <small>(pebble)</small>	\$575



Positano Oval Solid Surface Basin Above Counter Concrete

- 100% Solid Surface Material
- 505mm x 355mm x 110mm
- Concrete Colour Finish
- 5 Year Product Replacement Warranty
- 1 Year Labour
- 32mm Non-Overflow Waste Not Included



Code	R.R.P (inc GST)
POSOVSSBC <small>(concrete)</small>	\$575



Positano Oval Solid Surface Basin Above Counter White

- 100% Solid Surface Material
- 505mm x 355mm x 110mm
- Matte White Colour Finish
- 5 Year Product Replacement Warranty
- 1 Year Labour
- 32mm Non-Overflow Waste Not Included



Code	R.R.P (inc GST)
POSOVSSBW <small>(white)</small>	\$575



Eze Semi Inset Solid Surface Basin

- 100% Solid Surface Material
- 470mm x 345mm. 45mm Lip
- Matte White or Concrete Colour Finsih
- 5 Year Product Replacement Warranty
- 1 Year Labour
- 32mm Non-Overflow Waste Not Included

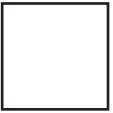
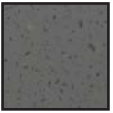
Code	R.R.P (inc GST)
EZEBSSMW <small>(white)</small>	\$575
EZEBSSC <small>(concrete)</small>	\$575



Mykonos Round Solid Surface Basin Above Counter Snow

- 100% Solid Surface Material
- 415mm DIA x 90mm
- Snow Finish
- 5 Year Product Replacement Warranty
- 1 Year Labour
- 32mm Non-Overflow Waste Not Included



Code	R.R.P (inc GST)
MYKSSSW (snow)	\$575



Mykonos Round Solid Surface Basin Above Counter Pebble

- 100% Solid Surface Material
- 415mm DIA x 90mm
- Pebble Finish
- 5 Year Product Replacement Warranty
- 1 Year Labour
- 32mm Non-Overflow Waste Not Included

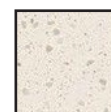

Code	R.R.P (inc GST)
MYKSSPB (pebble)	\$575



Mykonos Round Solid Surface Basin Above Counter Concrete

- 100% Solid Surface Material
- 415mm DIA x 90mm
- Concrete Colour Finish
- 5 Year Product Replacement Warranty
- 1 Year Labour
- 32mm Non-Overflow Waste Not Included



Code	R.R.P (inc GST)
MYKSSCO (concrete)	\$575



Mykonos Round Solid Surface Basin Above Counter White

- 100% Solid Surface Material
- 415mm DIA x 90mm
- Matte White Colour Finish
- 5 Year Product Replacement Warranty
- 1 Year Labour
- 32mm Non-Overflow Waste Not Included



Code	R.R.P (inc GST)
MYKSSWH (white)	\$575

SEE PAGE 48 FOR BASIN WASTE OPTIONS



Siera Solid Surface Wall Hung Basin White

- Solid Surface Matte Basin
- 5 year product replacement only
- 1 year labour
- No Taphole
- Can supply 1TH by request
- 450W x 330D x 150H
- Also available in 750W x 330D x 150H
- 32mm overflow waste required
- Available only in Matte White
- 450mm Basin has wall bolts included
- 750mm Basin has wall brackets included

Code	R.R.P (inc GST)
SIESS450WBW	\$625
SIESS750WBW	\$729



Siera Solid Surface Countertop Basin

- 4 sided basin polished all sides to enable top to be spun left or right hand bowl
- Designed for COUNTERTOP installations
- 32mm overflow waste required
- For wall hung application the holes and installation are to be to the installers discretion.
- 5 year product replacement only
- 1 year labour
- LEFT or RIGHT hand bowl
- Solid surface matte white

Code	R.R.P (inc GST)
UNITOP700 (with overflow)	\$839



Dodici 12L 700 Surface Countertop Basin with Overflow

- 4 sided basin polished all sides to enable top to be spun left or right hand bowl
- Designed for COUNTERTOP installations
- 12 litre "to the overflow" bowl capacity
- For wall hung application the holes and installation are to be to the installers discretion.
- 32mm overflow waste required
- 5 year product replacement only
- LEFT or RIGHT hand bowl
- Solid surface matte white
- 1 year labour
- Solid surface matte white

Code	R.R.P (inc GST)
DODICI	\$945



Victoriana Solid Surface Countertop Basin Non Overflow

- 4 sided basin polished all sides to enable top to be spun left or right hand bowl
- Solid Surface Matte Basin
- 5 year product replacement only
- 32mm non-overflow waste required
- 1 year labour
- No Taphole
- Can supply 1TH by request
- Available only in Matte White
- 600W x 400D x 160H

Code	R.R.P (inc GST)
VICTORIANA	\$839

SEE PAGE 48 FOR BASIN WASTE OPTIONS



Midnight Matte Black Round Glass Basin

- 420Ø x 150H
- “45mm hole only” to be cut into benchtop for this basin to allow for spacer
- 5 year product replacement only
- 1 year labour
- Supplied with Matte Black spacer for basin to sit on
- 32mm Non overflow waste required
- Made from matte black glass

Code	R.R.P (inc GST)
MIDRDGB	\$419



Midnight Matte Black Oval Glass Basin

- 495W x 390D x 140H
- “45mm hole only” to be cut into benchtop for this basin to allow for spacer
- 5 year product replacement only
- 1 year labour
- Supplied with Matte Black spacer for basin to sit on
- 32mm Non overflow waste required
- Made from matte black glass

Code	R.R.P (inc GST)
MIDOVGB	\$419



Midnight Matte Black Mini Glass Basin

- 310Ø x 110H
- “45mm hole only” to be cut into benchtop for this basin to allow for spacer
- 5 year product replacement only
- 1 year labour
- Supplied with Matte Black spacer for basin to sit on
- 32mm Non overflow waste required
- Made from matte black glass

Code	R.R.P (inc GST)
MIDMINIGB	\$369

SEE PAGE 48 FOR BASIN WASTE OPTIONS



Shadow Oval or Round Glass Basin

- 420Ø x 150H (round)
- 495W x 390D x 140H (oval)
- “45mm hole only” to be cut into benchtop for this basin to allow for spacer
- Supplied with spacer for basin to sit on
- 5 year product replacement only
- 1 year labour
- 32mm Non overflow waste required

Code	R.R.P (inc GST)
LDASHRGB (round)	\$419
LDASHOGB (oval)	\$419



Silver Sunset Oval or Round Glass Basin

- 420Ø x 150H (round)
- 495W x 390D x 140H (oval)
- “45mm hole only” to be cut into benchtop for this basin to allow for spacer
- Supplied with spacer for basin to sit on
- 5 year product replacement only
- 1 year labour
- 32mm Non overflow waste required

Code	R.R.P (inc GST)
SSRDGB (round)	\$419
SSOVGB (oval)	\$419



Black Marble Oval or Round Glass Basin

- 420Ø x 150H (round)
- 495W x 390D x 140H (oval)
- “45mm hole only” to be cut into benchtop for this basin to allow for spacer
- Supplied with spacer for basin to sit on
- 5 year product replacement only
- 1 year labour
- 32mm Non overflow waste required

Code	R.R.P (inc GST)
BMRDGB (round)	\$419
BMOVGB (oval)	\$419



Gold Oval or Round Glass Basin

- 420Ø x 140H (round)
- 495W x 390D x 140H (oval)
- “45mm hole only” to be cut into benchtop for this basin to allow for spacer
- Supplied with spacer for basin to sit on
- 5 year product replacement only
- 1 year labour
- 32mm Non overflow waste required

Code	R.R.P (inc GST)
GOLDRDGB (round)	\$419
GOLDOVGB (oval)	\$419

SEE PAGE 48 FOR BASIN WASTE OPTIONS



Urbino 460 Slim Basin Matte White

- Vitreous China
- 460W x 325D x 140H
- 5 year product replacement only
- 1 year labour
- 32mm Non overflow waste required
- Also available in Gloss White

Code	R.R.P (inc GST)
URBSL460-MW	\$367



Urbino 460 Slim Basin Matte Pink

- Vitreous China
- 460W x 325D x 140H
- 5 year product replacement only
- 1 year labour
- 32mm Non overflow waste required
- Also available in Gloss White

Code	R.R.P (inc GST)
URBSL460-MP	\$367



Urbino 460 Slim Basin Matte Grey

- Vitreous China
- 460W x 325D x 140H
- 5 year product replacement only
- 1 year labour
- 32mm Non overflow waste required
- Also available in Gloss White

Code	R.R.P (inc GST)
URBSL460-MG	\$367



Urbino 460 Slim Basin Matte Black

- Vitreous China
- 460W x 325D x 140H
- 5 year product replacement only
- 1 year labour
- 32mm Non overflow waste required
- Also available in Gloss White

Code	R.R.P (inc GST)
URBSL460-MB	\$367

SEE PAGE 48 FOR BASIN WASTE OPTIONS



Mini Siera Round 310mm Slim Ceramic Vessel Basin Matte White

- Vitreous China
- 310Ø x 120H (round)
- 5 year product replacement only
- 1 year labour
- 32mm Non overflow waste required
- Also available in Gloss White

Code	R.R.P (inc GST)
MINISIERVB-MW	\$367



Mini Siera Round 310mm Slim Ceramic Vessel Basin Matte Pink

- Vitreous China
- 310Ø x 120H (round)
- 5 year product replacement only
- 1 year labour
- 32mm Non overflow waste required
- Also available in Gloss White

Code	R.R.P (inc GST)
MINISIERVB-MP	\$367



Mini Siera Round 310mm Slim Ceramic Vessel Basin Matte Grey

- Vitreous China
- 310Ø x 120H (round)
- 5 year product replacement only
- 1 year labour
- 32mm Non overflow waste required
- Also available in Gloss White

Code	R.R.P (inc GST)
MINISIERVB-MG	\$367



Mini Siera Round 310mm Slim Ceramic Vessel Basin Matte Black

- Vitreous China
- 310Ø x 120H (round)
- 5 year product replacement only
- 1 year labour
- 32mm Non overflow waste required
- Also available in Gloss White

Code	R.R.P (inc GST)
MINISIERVB-MB	\$367

SEE PAGE 48 FOR BASIN WASTE OPTIONS



Siera Round Slimline 360mm Ceramic Vessel Basin Matte White

- Vitreous China
- 360Ø x 120H (round)
- 5 year product replacement only
- 1 year labour
- 32mm Non overflow waste required
- Also available in Gloss White

Code	R.R.P (inc GST)
SIERVB-MW	\$367



Siera Round Slimline 360mm Ceramic Vessel Basin Matte Pink

- Vitreous China
- 360Ø x 120H (round)
- 5 year product replacement only
- 1 year labour
- 32mm Non overflow waste required
- Also available in Gloss White

Code	R.R.P (inc GST)
SIERVB-MP	\$367



Siera Round Slimline 360mm Ceramic Vessel Basin Matte Grey

- Vitreous China
- 360Ø x 120H (round)
- 5 year product replacement only
- 1 year labour
- 32mm Non overflow waste required
- Also available in Gloss White

Code	R.R.P (inc GST)
SIERVB-MG	\$367



Siera Round Slimline 360mm Ceramic Vessel Basin Matte Black

- Vitreous China
- 360Ø x 120H (round)
- 5 year product replacement only
- 1 year labour
- 32mm Non overflow waste required
- Also available in Gloss White

Code	R.R.P (inc GST)
SIERVB-MB	\$367

SEE PAGE 48 FOR BASIN WASTE OPTIONS



Positano 460 Basin Matte White

- 460W x 325D x 140H
- 5 year product replacement only
- 1 year labour
- 32mm Non overflow waste required
- Also available in Gloss White

Code	R.R.P (inc GST)
POSITANO460-MW	\$367



Positano 460 Basin Matte Pink

- 460W x 325D x 140H
- 5 year product replacement only
- 1 year labour
- 32mm Non overflow waste required
- Also available in Gloss White

Code	R.R.P (inc GST)
POSITANO460-MP	\$367



Positano 460 Basin Matte Grey

- 460W x 325D x 140H
- 5 year product replacement only
- 1 year labour
- 32mm Non overflow waste required
- Also available in Gloss White

Code	R.R.P (inc GST)
POSITANO460-MG	\$367



Positano 460 Basin Matte Black

- 460W x 325D x 140H
- 5 year product replacement only
- 1 year labour
- 32mm Non overflow waste required
- Also available in Gloss White

Code	R.R.P (inc GST)
POSITANO460-MB	\$367

SEE PAGE 48 FOR BASIN WASTE OPTIONS



Thames Semi Inset Round Basin Matte Black

- Vitreous China
- 395Ø x 115H (round)
- 5 year product replacement only
- 1 year labour
- 65mm LIP
- 32mm Non overflow waste required
- Can be used as above counter basin or inset basin

• Also available in Gloss White

Code	R.R.P (inc GST)
THASIVB-MB	\$367



Thames Semi Inset Round Basin Matte White

- Vitreous China
- 395Ø x 115H (round)
- 5 year product replacement only
- 1 year labour
- 65mm LIP
- 32mm Non overflow waste required
- Can be used as above counter basin or inset basin

• Also available in Gloss White

Code	R.R.P (inc GST)
THASIVB-MW	\$367



Siera Semi Inset Round Basin Matte White

- Vitreous China
- 360Ø x 115H (round)
- 5 year product replacement only
- 1 year labour
- 65mm LIP
- 32mm Non overflow waste required
- Can be used as above counter basin or inset basin

• Also available in Gloss White

Code	R.R.P (inc GST)
SIESIVB-MW	\$367



Siera Semi Inset Round Basin Matte Black

- Vitreous China
- 360Ø x 115H (round)
- 5 year product replacement only
- 1 year labour
- 65mm LIP
- 32mm Non overflow waste required
- Can be used as above counter basin or inset basin

• Also available in Gloss White

Code	R.R.P (inc GST)
SIESIVB-MB	\$367

SEE PAGE 48 FOR BASIN WASTE OPTIONS



Roma Above Counter Basin Matte White

- Vitreous China
- 400 (round) x 110H
- 5 year product replacement only
- 1 year labour
- 32mm Non overflow waste required
- Also available in Gloss White

Code	R.R.P (inc GST)
ROMAVB-MW	\$379



Roma Mini Above Counter Basin Matte White

- Vitreous China
- 320 (round) x 110H
- 5 year product replacement only
- 1 year labour
- 32mm Non overflow waste required
- Also available in Gloss White

Code	R.R.P (inc GST)
MINIROMA-MW	\$379



Siera Flute Above Counter Basin Matte White

- Vitreous China
- 360W x 120H
- 5 year product replacement only
- 1 year labour
- 32mm waste required
- Also available in Gloss White

Code	R.R.P (inc GST)
SIEFLVB-MW	\$399



Siera Flute Above Counter Basin Matte Black

- Vitreous China
- 360W x 120H
- 5 year product replacement only
- 1 year labour
- 32mm waste required
- Also available in Gloss White

Code	R.R.P (inc GST)
SIEFLVB-MB	\$399



Piazza Basin Square Matte White

- Vitreous China
- 360W x 360D x 120H
- 5 year product replacement only
- 1 year labour
- 32mm Non overflow waste required
- Also available in Gloss White

Code	R.R.P (inc GST)
PIAVB-MW	\$379

SEE PAGE 48 FOR BASIN WASTE OPTIONS

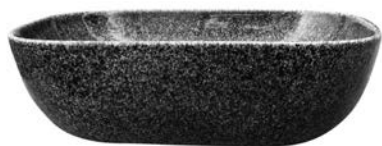

Urbino 460 Slim Black Crystal Basin

- Vitreous China
- Gloss finish
- 460W x 325D x 140H
- 5 year product replacement only
- 1 year labour
- 32mm Non overflow waste required

Code	R.R.P (inc GST)
URBSL460-BC	\$349



Urbino 460 Slim EDGE Vessel Basin

- Vitreous China
- Gloss white with black edge
- 460W x 325D x 140H
- 5 year product replacement only
- 1 year labour
- 32mm waste required
- 32mm Non overflow waste required

Code	R.R.P (inc GST)
URBSL460-EDGE	\$335



Siera Round 360mm Slim EDGE vessel Basin

- Vitreous China
- Gloss white with black edge
- 360Ø x 120H (round)
- 5 year product replacement only
- 1 year labour
- 32mm Non overflow waste required

Code	R.R.P (inc GST)
SIERVB-EDGE	\$335



Siera Mini Round 360mm Slim EDGE vessel Basin

- Vitreous China
- Gloss white with black edge
- 310Ø x 120H
- 5 year product replacement only
- 1 year labour
- 32mm Non overflow waste required

Code	R.R.P (inc GST)
MINISIERV-EDGE	\$335

SEE PAGE 48 FOR BASIN WASTE OPTIONS



Selena Oval Drop In Basin with Overflow

- Vitreous China 1TH
- 570W x 440D
- 5 year product replacement only
- 1 year labour
- 32mm Overflow waste required

Code	R.R.P (inc GST)
SEOVB	\$125
DRILLCHARGE (3 TH)	\$50



Bianca Square Drop In Basin with Overflow

- Vitreous China 1TH
- 420W x 420D
- 5 year product replacement only
- 1 year labour
- 32mm Overflow waste required

Code	R.R.P (inc GST)
BISQVB	\$205
DRILLCHARGE (3 TH)	\$50



Belinda Drop In Basin with Overflow

- Vitreous China 1TH
- 5 year product replacement only
- 1 year labour
- 525W x 450D
- 32mm Overflow waste required

Code	R.R.P (inc GST)
BELSQVB	\$249
DRILLCHARGE (3 TH)	\$50



Sarah Oval Drop In Basin

- 560W x 470D
- 5 year product replacement only
- 1 year labour
- 32mm Overflow waste required

Code	R.R.P (inc GST)
SAROVb	\$125



Sotto Ceramic Undermount Basin with Overflow

- 535W x 335D x 180H (30mm edge)
- 5 year product replacement only
- 1 year labour
- 32mm Overflow waste required

Code	R.R.P (inc GST)
SOTUMVB	\$209

SEE PAGE 48 FOR BASIN WASTE OPTIONS



Positano Inset Basin with Overflow

- Vitreous China
- 600W x 400D x 180H
- 60mm lip
- 5 year product replacement only
- 1 year labour
- 32mm overflow waste required

Code	R.R.P (inc GST)
POSINSET	\$269



Siera Inset Round Basin White

- Vitreous China 1TH
- 360Ø x 115H (round)
- 55mm LIP
- Also available in Matte White and Matte Black
- 5 year product replacement only
- 1 year labour
- 32mm Non overflow waste required

Code	R.R.P (inc GST)
SIESIVB	\$249



Thames Semi Inset Round Basin White

- Vitreous China
- 395Ø x 115H (round)
- 70mm LIP
- Also available in Matte White and Matte Black
- 5 year product replacement only
- 1 year labour
- 32mm Non overflow waste required
- Can be used as vessel basin or inset basin

Code	R.R.P (inc GST)
THASIVB	\$249



Shania Inset Basin

- Vitreous China
- 535W x 335D x 170H
- 70mm lip
- 5 year product replacement only
- 1 year labour
- 32mm Non overflow waste required

Code	R.R.P (inc GST)
SHAINVB	\$219



Urbino Inset Basin

- Vitreous China
- 5 year replacement warranty
- 1 year labour
- 480W x 300D x 130H
- 60mm lip
- 32mm Non overflow waste required

Code	R.R.P (inc GST)
URBINSET	\$235

SEE PAGE 48 FOR BASIN WASTE OPTIONS



Vanessa Round Semi Inset Basin with Overflow

- Vitreous China 1TH
- 440Ø (round)
- 45mm LIP
- Rear of basin IS glazed and enclosed for mirror installation
- 5 year product replacement only
- 1 year labour
- 32mm Overflow waste required

Code	R.R.P (inc GST)
VANSIB	\$239



Simone Inset Basin with Overflow

- Vitreous China 1TH
- 470mm diameter x 80H lip
- Rear of basin IS glazed and enclosed for mirror installation
- 5 year product replacement only
- 1 year labour
- 32mm Overflow waste required

Code	R.R.P (inc GST)
SIMIB	\$269



Madonna Inset Basin

- Vitreous China 1TH
- 420W x 420D x120H
- 60mm lip
- Rear of basin IS glazed and enclosed for mirror installation
- 5 year product replacement only
- 1 year labour
- 32mm non overflow waste required

Code	R.R.P (inc GST)
MADOIB	\$269



Venice Semi Inset Basin

- Vitreous China 1TH
- 440W x 380D
- 65mm lip
- Rear of basin IS glazed and enclosed for mirror installation
- 5 year product replacement only
- 1 year labour
- 32mm Overflow waste required

Code	R.R.P (inc GST)
VENSIVB	\$259

SEE PAGE 48 FOR BASIN WASTE OPTIONS



Caprice Semi Recessed Basin

- Vitreous China 1TH
- 5 year replacement warranty
- Rear of basin IS glazed and enclosed for mirror installation
- 1 year labour
- 485W x 460D x 150H
- 315mm recess
- 32mm Overflow waste required

Code	R.R.P (inc GST)
CASRVB	\$219
DRILLCHARGE (3 TH)	\$50



Riviera 420 Semi Recessed Basin

- Vitreous China 1TH
- 420W x 420L
- Rear of basin IS glazed and enclosed for mirror installation
- 5 year product replacement only
- 1 year labour
- 32mm overflow waste required

Code	R.R.P (inc GST)
RIV420SRB	\$219



Riviera Mini Ceramic Wall Hung/Above Counter Basin

- Vitreous China 1TH
- **Wall hung or countertop basin**
- Wall bolts **NOT** included
- Rear of basin IS NOT glazed and enclosed for mirror installation
- 365W x 250D
- 5 year product replacement only
- 1 year labour
- 32mm Non overflow waste required

Code	R.R.P (inc GST)
RIVMINIVB	\$209



Riviera 420/500 Ceramic Wall Hung/Above Counter Basin with Overflow

- Vitreous China 1TH
- **Wall hung or countertop basin**
- Wall bolts **NOT** included
- Rear of basin IS NOT glazed and enclosed for mirror installation
- 5 year product replacement only
- 1 year labour
- 32mm Overflow waste required
- 420W x 420D x 120H
- 500W x 420D x 120H

Code	R.R.P (inc GST)
RIV420VB	\$209
RIV500VB	\$239
DRILLCHARGE (3 TH)	\$50



Mini Madrid Basin & Madrid Basin

- Vitreous China 1TH
- **Can be wall hung**
- Rear of basin IS NOT glazed and enclosed for mirror installation
- Wall bolts **NOT** included
- 5 year product replacement only
- 1 year labour
- 32mm Non overflow waste required
- 440W x 340D x 100H
- 440W x 440D x 100H

Code	R.R.P (inc GST)
MINIMADSQVB	\$209
MADSQVB	\$219

SEE PAGE 48 FOR BASIN WASTE OPTIONS



Toni Wall Hung Basin with Overflow

- Vitreous China 1TH
- 520W x 255D x 115H
- Comes with wall fixing bolts
- 5 year product replacement only
- 1 year labour
- Right hand tap only
- 32mm Overflow waste required

Code	R.R.P (inc GST)
TONIWB	\$209



Tahli Wall Hung Basin with Overflow

- Vitreous China 1TH
- 510W x 260D x 120H
- Comes with wall fixing bolts
- 5 year product replacement only
- 1 year labour
- Right hand tap only
- 32mm Overflow waste required

Code	R.R.P (inc GST)
TAHWB	\$209



Cura Care Wall Hung Basin with Overflow

- Vitreous China 1TH
- 515W x 430D
- 5 year product replacement only
- 1 year labour
- Comes with wall fixing bolts
- 32mm Overflow waste required

Code	R.R.P (inc GST)
CURACBW	\$225



Cura Care Shroud

- Vitreous China
- 5 year product replacement only
- 1 year labour
- Bolts included

Code	R.R.P (inc GST)
CURACASH	\$145

SEE PAGE 48 FOR BASIN WASTE OPTIONS
SEE PAGE 111 FOR BOTTLE TRAP OPTIONS



Siera Round Slimline Above Counter Basin

- Vitreous China
- 360Ø x 120H (round)
- 5 year product replacement only
- 1 year labour
- 32mm Non overflow waste required
- Also available in matte colours (see matte basins)

Code	R.R.P (inc GST)
SIERAVB	\$219



Mini Siera Round Above Counter Basin

- Vitreous China
- 310Ø x 120H
- 5 year product replacement only
- 1 year labour
- 32mm Non overflow waste required
- Also available in matte colours (see matte basins)

Code	R.R.P (inc GST)
MINISIERAVB	\$219



Urbino 400 Slim Basin Above Counter

- Vitreous China
- 400W x 400D x 150H
- 5 year product replacement only
- 1 year labour
- 32mm Non overflow waste required

Code	R.R.P (inc GST)
URBSL400	\$219



Urbino 460/500 Slim Basin Above Counter

- Vitreous China
- 460W x 325D x 140H
- 500W x 400D x 140H
- 5 year product replacement only
- 1 year labour
- 32mm Non overflow waste required
- Also available in matte colours (see matte basins)

Code	R.R.P (inc GST)
URBSL460	\$219
URBSL500	\$229



Roma Above Counter Basin

- Vitreous China
- 400 (round) x 110H
- 5 year product replacement only
- 1 year labour
- Available Matt White (See Matt Ceramic)
- 32mm Non overflow waste required

Code	R.R.P (inc GST)
ROMAVB	\$219

SEE PAGE 48 FOR BASIN WASTE OPTIONS



Mini Roma Above Counter Basin

- Vitreous China
- 320 (round) x 110H
- 5 year product replacement only
- 1 year labour
- Available Matt White (See Matt Ceramic)
- 32mm Non overflow waste required

Code	R.R.P (inc GST)
MINIROMAVB	\$219



Barca Above Counter Basin

- Vitreous China
- 545W x 410D x 140H
- 5 year product replacement only
- 1 year labour
- 32mm Non overflow waste required

Code	R.R.P (inc GST)
BARVB	\$249



Halo Round 400 Above Counter Basin

- Vitreous China
- 400 Diameter 150H
- 5 year product replacement only
- 1 year labour
- 32mm Non overflow waste required

Code	R.R.P (inc GST)
HLVB	\$239



Halo Round 360 Above Counter with Overflow Basin

- Vitreous China
- 360 Diameter 150H
- 5 year product replacement only
- 1 year labour
- 32mm overflow waste required

Code	R.R.P (inc GST)
HALWOF	\$239



Adana Above Counter Basin

- Vitreous China
- 490W x 350D x 135H
- 5 year product replacement only
- 1 year labour
- 32mm Non overflow waste required

Code	R.R.P (inc GST)
ADARVB	\$239

SEE PAGE 48 FOR BASIN WASTE OPTIONS



Sorriso Oval Above Counter Basin

- Vitreous China
- 410W x 330D x 145H
- 5 year product replacement only
- 1 year labour
- 32mm Non overflow waste required

Code	R.R.P (inc GST)
SOROVVB	\$205



Zola Square Above Counter Basin with Overflow

- Vitreous China 1TH
- 480W x 440D x 80H
- Rear of basin IS glazed and enclosed for mirror installation
- 5 year product replacement only
- 1 year labour
- 32mm Overflow waste required

Code	R.R.P (inc GST)
ZOSQVB	\$205



Jodie Oval Above Counter Basin

- Vitreous China 1TH
- 500W x 380D x 120H
- Rear of basin IS glazed and enclosed for mirror installation
- 5 year product replacement only
- 1 year labour
- 32mm non overflow waste required

Code	R.R.P (inc GST)
JODVB	\$209



Eclipse Above Counter Ceramic Basin

- Vitreous China
- 500W x 350D x 90H
- 5 year product replacement only
- 1 year labour
- 32mm Non overflow waste required

Code	R.R.P (inc GST)
ECLIPSE	\$209



Prague Square Above Counter Basin

- Vitreous China
- 480W x 380D x 140H
- 5 year product replacement only
- 1 year labour
- 32mm Non overflow waste required

Code	R.R.P (inc GST)
PRASQVB	\$209

SEE PAGE 48 FOR BASIN WASTE OPTIONS



Siera Groove Above Counter Basin Gloss White

- Vitreous China
- 360 Diameter x 120H
- 5 year product replacement only
- 1 year labour
- 32mm Non overflow waste required

Code	R.R.P (inc GST)
SIEGROOVB	\$269



Siera Flute Above Counter Basin Gloss White

- Vitreous China
- 360 Diameter x 120H
- Also available in Matte White and Matte Black
- 5 year product replacement only
- 1 year labour
- 32mm Non overflow waste required

Code	R.R.P (inc GST)
SIEFLVB	\$269



Piazza Square Above Counter Basin Gloss White

- Vitreous China
- 360W x 360D x 120H
- Also available in Matte White
- 5 year product replacement only
- 1 year labour
- 32mm Non overflow waste required

Code	R.R.P (inc GST)
PIAVB	\$249



Positano 460 Slim Ceramic Above Counter Basin

- 460W x 325D x 140H
- 5 year product replacement only
- 1 year labour
- 32mm Non overflow waste required
- Also available in matte colours
(see matte basins)

Code	R.R.P (inc GST)
POSITANO460	\$209



Isabella Rectangle Above Counter Basin

- Vitreous China
- 500W x 340D x 110H
- 5 year product replacement only
- 1 year labour
- 32mm Non overflow waste required

Code	R.R.P (inc GST)
ISAVSVB	\$229



Uni-Pop Pop-up Waste Chrome/Black/Brushed Nickel

- Universal to suit with or without overflow basins
- Multifit 32mm top with 40mm base
- 7 year product replacement only
- 2 year warranty on black finish
- Chrome plated solid brass, Matte Black, Brushed Nickel or Gun Metal

Code	R.R.P (inc GST)
UNIPOP-CH	\$41
UNIPOP-BL	\$58
UNIPOP-NI	\$69
UNIPOP-GM	\$75



Pop Up Basket Pullout Waste Chrome

- Completely removable basket waste insert - Plumber code approved
- 7 year product replacement only
- Chrome plated solid brass
- 40mm only available Non-Overflow
- 40mm recommended for baths only

Code	R.R.P (inc GST)
POBAS32SWC (32mm non-overflow)	\$52
POBAS320FC (32mm overflow)	\$52



Pop Up Basket Pullout Waste Black

- ALSO SUPPLIED WITH DOME CAP OPTION IN BOX
- Completely removable basket waste insert - Plumber code approved
- 7 year product replacement only
- 2 year warranty on black finish
- Matte black finish

Code	R.R.P (inc GST)
POBAS32SW-BL (32mm non-overflow)	\$75
POBAS320F-BL (32mm overflow)	\$75



Ceramic Cap with Pop Up Basket Pullout Waste Chrome

- 32mm Non-Overflow Waste
- ALSO SUPPLIED WITH DOME CAP OPTION IN BOX
- Completely removable basket waste insert
- Plumber code approved
- 7 year product replacement only
- Chrome plated solid brass
- Black waste supplied for POBAS32SW-BLMB

Code	R.R.P (inc GST)
POBAS32SW-GW (Gloss white)	\$75
POBAS32SW-MW (Matte White)	\$75
POBAS32SW-MP (Matte Pink)	\$75
POBAS32SW-MG (Matte Grey)	\$75
POBAS32SW-BLMB (Matte Black)	\$85

WHITE

BRUSHED NICKEL

GUN METAL

BLACK



Round Overflow Dress Rings

- White and Chrome are **ABS plastic** overflow dress rings
- Black/Brushed Nickel/Gunmetal are **PVD Metal flexifit** overflow dress rings
- Suitable for any overflow basin with round overflow ring
- Suitable for Genoa ceramic vanity top with overflow

Code	R.R.P (inc GST)
OFRING-WH (Gloss White)	\$15 (bag of 5)
OFRING-CH (Chrome)	\$15 (bag of 5)
OFRING-BL (Matt Black)	\$15 each
OFRING-NI (Brushed Nickel)	\$15 each
OFRING-GM (Gun Metal)	\$15 each

TOILETS



Toilet Warranty

- 20 year on vitreous china product replacement only
- 5 year on UV resistance product replacement only
- 3 year internal value product replacement only
- 1 year product replacement and labour (does not cover loose seat)



Positano Rimless Wall Faced Toilet Suite

- Manufactured from Vitreous China
- **Bottom Inlet Conversion Kit available***
- 20 Year Vitreous China Replacement Warranty
- WDI Valves, Back Inlet
- Extra Height, Ambulant Compliant
- UF Gloss White Soft Closing Seat
- Supplied With Adjustable Bend 90-180mm
- WELS 4 Star 4.5/3 (3.3L AVG Flush)
- High Quality UF soft close seat
- WDI valves
- Australian Designed
- Rimless Flush Technology

Code	R.R.P (inc GST)
POSWFPW	\$669
BICK*	\$49



Rossi Rimless Wall Faced Toilet Suite

- **Rossi Ambulant height upgrade with 40mm UF seat***
- **Bottom Inlet Conversion Kit available***
- 20 Year Vitreous China Replacement Warranty
- Manufactured from Vitreous China
- WDI Valves, Back Inlet
- Supplied With Adjustable Bend 90-180mm
- WELS 4 Star 4.5L/3L (3.3L AVG Flush)
- Optional Ambulant Upgrade with UF Seat
- PP Soft Close Seat
- Rimless Flush Technology

Code	R.R.P (inc GST)
ROSWFPW	\$629
ROSWFPW-AH*(UF Seat)	\$649
BICK*	\$49



Siera Wall Faced Toilet Suite

- S Trap vario bend included(Adj 90 - 180mm setout)*
- **Bottom Inlet Conversion Kit available***
- 20 Year Vitreous China Replacement Warranty
- WDI Valves, Back Inlet
- Soft close seat (Quick release)
- Optional Siera extended Vario bend (140mm to 220mm)
- WDI valves
- 4 Star 3.5 Litres average flush

Code	R.R.P (inc GST)
SIWFPW	\$515
BICK*	\$49



Lucca S-trap C/C Toilet Suite

- 140mm set out
- Rear entry kit available (REARENTKT)* - Rear inlet + Cistern Plug + Adaptor Valve
- 20 Year Vitreous China Replacement Warranty
- Interchangeable bottom R/L inlet
- Soft close seat (Quick release)
- 4 Star 3.5 Litres average flush
- WDI valves

Code	R.R.P (inc GST)
LUCCSW	\$335
*REARENTKT	\$49



Lucca P-trap C/C Toilet Suite

- Interchangeable bottom R/L inlet
- Rear entry kit available (REARENTKT)* - Rear inlet + Cistern Plug + Adaptor Valve
- 20 Year Vitreous China Replacement Warranty
- Soft close seat (Quick release)
- 4 Star 3.5 Litres average flush
- WDI valves

Code	R.R.P (inc GST)
LUCCPW	\$335
*REARENTKT	\$49



Napoli RIMLESS Wall Faced Pan Only for Inwall Cistern

See Geberit options below

- 4 star 4.5/3 litres (3.3 litre average flush)
- Heavy Duty UF seat soft close and quick release
- 20 Year Vitreous China Replacement Warranty
- S Trap setout measurement for this toilet cannot exceed 155mm
- Supplied with 100mm Vario Bend (NAPCOL)
- For other setouts see Vario Bend options
- Gerberit approved flush tested

Code	R.R.P (inc GST)
NAPBIWP	\$469



Positano RIMLESS Wall Faced Pan ONLY for Inwall Cistern

See Geberit options below

- Heavy Duty UF seat soft close and quick release
- 20 Year Vitreous China Replacement Warranty
- 4 star 4.5/3 litres (3.3 litre average flush)
- S Trap setout measurement for this toilet cannot exceed 155mm
- Extra Height Pan
- Supplied with 100mm Vario Bend (NAPCOL)
- For other setouts see Vario Bend options
- Gerberit approved flush tested

Code	R.R.P (inc GST)
POSIWP	\$419



Comodo Inwall Cistern HDPE Suit Wall Cavity

- Comodo Inwall Cistern HDPE Suit 80mm Min Wall Cavity "New Model"
- Suitable for S & P Trap Back To Wall Floor Pans
- HDPE Inwall One Piece Tank
- Operation - Suits Castano Mechanical Press Dual Flush Buttons
- Suits Min 80mm Stud Walls
- Dual Flush
- WELS 4 Star 4.5/3L (3.4L AVG Flush)
- Mains Pressure Min 100 - 500KPA
- Registration L06855
- Product Warranty 15 Years Tank
- Product Warranty 3 Years Valve
- Labour Warranty 12 Months

Code	R.R.P (inc GST)
COMIWC	\$299

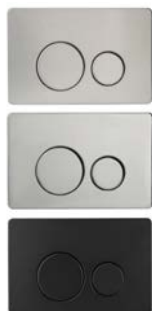

Comodo Button

- 2 year warranty
- Stainless Steel Construction
- Comodo Brushed Stainless Steel Button
- Comodo Chrome Button
- Comodo Matte Black Button

Code	R.R.P (inc GST)
COMRB-BS	\$169
COMRB-C	\$169
COMRB-MB	\$169



Geberit Sigma 8 Inwall Cistern

- WELS 4 Star 3.5 L/3L average flush
- 15 Year warranty
- Suitable for S or P trap back to wall pans
- Fits standard 90mm walls
- Made in Germany

■ GEBERIT

Code	R.R.P (inc GST)
GSIG8IWC	\$499



Geberit Sigma 20 Round Button

- 2 year warranty
- Available in Chrome/Matte Chrome (115.882.KH.1)
- Available in Matte Black (115.882.16.1)
- Available in Matte White (115.882.01.1)

■ GEBERIT

Code	R.R.P (inc GST)
GSIG20RB-C	\$210
GSIG20RB-MB	\$249
GSIG20RB-MW	\$249



Geberit Sigma 30 Square Button

- 2 year warranty
- Available in Chrome/Matte Chrome (115.883.KH.1)
- Available in Matte Black(115.883.16.1)
- Available in Matte White(115.883.01.1)

■ GEBERIT

Code	R.R.P (inc GST)
GSIG30SB-C	\$210
GSIG30SB-MB	\$249
GSIG30SB-MW	\$249



Siera/Rossi - Black/Nickel Cistern Button Assembly

- Suits Sierra or Rossi Cistern
- WDI brand
- Matte Black or Brushed Nickle

Code	R.R.P (inc GST)
SIROBCBA (black)	\$33
SIROBCBA-N (brushed nic)	\$33



Positano Vario Bend

- 2 year warranty
- Suits Napoli inwall & Positano inwall suites 45mm to 55mm
- Suits Positano and Siera wall faced suites 90-180mm

Code	R.R.P (inc GST)
POSCOL	\$66



Napoli Vario Bend

- 2 year warranty
- Suits Napoli inwall & Positano inwall suites 100mm
- Suits Positano and Siera wall face suites 100-180mm

Code	R.R.P (inc GST)
NAPCOL	\$66



Siera Extended Vario Bend

- 2 year warranty
- Suits Siera suite 140mm to 220mm
- Suits Napoli inwall & Positano inwall suites 135mm to 145mm
- Suits Positano suite 140mm to 200mm
- Suits Rossi wall face suite 140 to 180mm

Code	R.R.P (inc GST)
SIEXCOL	\$66



ROSEAT for Rossi/Siera/Napoli (PP seat)

- 5 year UV resistance warranty
- Shiny Clean look (PP seat)
- Very Flexible (PP seat)
- Lightweight (PP seat)
- Push button quick release

Code	R.R.P (inc GST)
ROSEAT (PP seat)	\$78



UFSEAT for Rossi/Siera/Napoli (UF seat)

- 5 year UV resistance warranty
- High scratch resistance
- Easy to clean
- Hard ceramic look (UF seat)
- Push button quick release
- High scratch resistance (UF seat)
- Easy to clean (UF seat)

Code	R.R.P (inc GST)
UFSEAT (UF seat)	\$88



POSSEAT for Positano (UF seat)

- 5 year UV resistance warranty
- High scratch resistance
- Easy to clean
- Hard ceramic look (UF seat)
- Push button quick release
- High scratch resistance (UF seat)
- Easy to clean (UF seat)

Code	R.R.P (inc GST)
POSSEAT (UF seat)	\$88



UF Slimline Seat for Rossi/Siera/Positano/Napoli (UF seat)

- 5 year UV resistance warranty
- High scratch resistance
- Easy to clean
- Hard ceramic look (UF seat)
- Push button quick release
- High scratch resistance (UF seat)
- Easy to clean (UF seat)

Code	R.R.P (inc GST)
SLIMSEAT (UF seat)	\$88

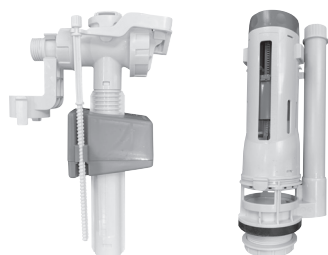

Inlet or Outlet Valve for Rossi/Siera/Positano

- 3 year replacement warranty
- WDI brand

Code	R.R.P (inc GST)
INLETVALVE	\$33
OUTLETVALVE	\$88



Bottom Inlet Valve for Lucca/Rossi/Siera/Positano

- 3 year replacement warranty
- WDI brand

Code	R.R.P (inc GST)
BOTINVALVE	\$49



Mini Cistern Cock Black with Wall Plate

- 2 year warranty
- Matte Black only
- Red and blue indicator in box

Code	R.R.P (inc GST)
MCC-B	\$55

TAPWARE AND SHOWERS





Capri 35mm Wall Mixer or Shower Diverter Chrome

- 35mm cartridge
- 1/2 turn ceramic disc diverter
- 7 year warranty on cartridge
- 1 year parts and labour

Code	R.R.P (inc GST)
CAWAC35 (Mixer)	\$90
CAWDIC (Diverter)	\$139



Capri 35mm Swivel Basin Mixer Chrome

- 35mm cartridge
- 7 year warranty on cartridge
- 1 year parts and labour
- 10 years on flexible tails, product replacement only
- 2 pin fixing kit
- PEX tails
- 4 stars 7L/Min

Code	R.R.P (inc GST)
CABAC35	\$99



Capri 35mm Fixed Basin Mixer Chrome

- 35mm cartridge
- 7 year warranty on cartridge
- 1 year parts and labour
- 10 years on flexible tails, product replacement only
- 2 pin fixing kit
- PEX tails
- 5 stars 6.0L/Min

Code	R.R.P (inc GST)
CAF BMC35	\$99



Capri 35mm Sink Mixer Chrome

- 35mm cartridge
- 7 year warranty on cartridge
- 1 year parts and labour
- 10 years on flexible tails, product replacement only
- 2 pin fixing kit
- PEX tails
- 4 stars 7L/Min

Code	R.R.P (inc GST)
CASIC35	\$99



Capri 35mm CARE Wall Mixer Chrome

- 35mm cartridge
- 1/2 turn ceramic disc diverter
- 7 year warranty on cartridge
- 1 year warranty on parts and labour

Code	R.R.P (inc GST)
CAWAC35-CARE (Mixer)	\$110
CAWDIC35-CARE (Diverter)	\$140



Capri 35mm CARE Swivel Basin Mixer Chrome

- 35mm cartridge
- 7 year warranty on cartridge
- 1 year parts and labour
- 10 years on flexible tails, product replacement only
- 2 pin fixing kit
- PEX tails
- 4 stars 7L/Min

Code	R.R.P (inc GST)
CABAC35-CARE	\$115



Capri 35mm CARE Fixed Basin Mixer Chrome

- 35mm cartridge
- 7 year warranty on cartridge
- 1 year parts and labour
- 10 years on flexible tails, product replacement only
- 2 pin fixing kit
- PEX tails
- 5 stars 6.0L/Min

Code	R.R.P (inc GST)
CAFBMC35-CARE	\$115



Capri 35mm CARE Sink Mixer Chrome

- 35mm cartridge
- 7 year warranty on cartridge
- 1 year parts and labour
- 10 years on flexible tails, product replacement only
- 2 pin fixing kit
- PEX tails
- 4 stars 7L/Min

Code	R.R.P (inc GST)
CASIC35-CARE	\$115



Capri 35mm CARE Handle Chrome

- 35mm handle suits capri35/milan/siera
- 1 year parts and labour
- Suits Capri 35mm/Milan/Siera/Elba

Code	R.R.P (inc GST)
CADISHC35	\$49



Capri 35mm Wall Mixer or Shower Diverter Black

- 35mm cartridge
- Ceramic disc diverter
- 7 year warranty
- 2 year warranty on Black finish

Code	R.R.P (inc GST)
CAWAC35-B (Mixer)	\$109
CAWDIC35-B (Diverter)	\$149



Capri 35mm Fixed Basin Black

- 35mm cartridge
- 7 year warranty on cartridge
- 2 year warranty on Black finish
- 1 year part and labour
- 10 years on flexible tails, product replacement only
- 2 pin fixing kit
- PEX tails
- 5 stars 6.0L/Min

Code	R.R.P (inc GST)
CAFBMC35-B	\$149



Capri 35mm Sink Mixer Black

- 35mm cartridge
- 7 year warranty on cartridge
- 2 year warranty on Black finish
- 1 year parts and labour
- 10 years on flexible tails, product replacement only
- 2 pin fixing kit
- PEX tails
- 4 stars 7L/Min

Code	R.R.P (inc GST)
CASIC35-B	\$149



Capri 35 Care Handle Black

- 35mm cartridge
- 7 year warranty on cartridge
- 2 year warranty on Black finish
- 1 year parts and labour
- Suits Capri 35mm/Milan/Siera/Elba

Code	R.R.P (inc GST)
CADISHC35-B	\$59



Capri 40mm Wall Mixer or Shower Diverter Chrome

- 40mm cartridge
- 7 year warranty on cartridge
- 1 year parts and labour
- Push-Pull diverter

Code	R.R.P (inc GST)
CAWAC (Mixer)	\$95
CAWDIC (Diverter)	\$145



Capri 40mm Swivel Basin Mixer Chrome

- 40mm cartridge
- 7 year warranty on cartridge
- 1 year warranty parts and labour
- 10 years on flexible tails, product replacement only
- 2 pin fixing kit
- PEX tails
- 5 stars 6.0L/Min
- 6 star option available

Code	R.R.P (inc GST)
CABAC	\$115
CABAC6S (6 star)	\$115



Capri 40mm Fixed Basin Mixer Chrome

- 40mm cartridge
- 7 year warranty on cartridge
- 1 year warranty parts and labour
- 10 years on flexible tails, product replacement only
- 2 pin fixing kit
- PEX tails
- 5 stars 6.0L/Min
- 6 star option available

Code	R.R.P (inc GST)
CAF BMC	\$115
CAF BMC6S (6 star)	\$115



Capri 40mm Sink Mixer Chrome

- 40mm cartridge
- 10 years on flexible tails, product replacement only
- 7 year warranty on cartridge
- 1 year warranty parts and labour
- 2 pin fixing kit
- PEX tails
- 4 stars 6.5L/Min
- 5 or 6 star options available

Code	R.R.P (inc GST)
CASIC	\$115
CASIC6S (6 star)	\$115



Capri 40mm CARE Handle Chrome

- Only suitable for Capri 40mm mixers
- 1 year warranty parts and labour

Code	R.R.P (inc GST)
CADISHC	\$49



Capri Shower on Rail Chrome

- 10 year product replacement only
- 1 year labour
- 1 year hose product replacement only
- 3 Function ABS handpiece
- Push button slider
- Clip on soap dish
- 4 stars 6.5L/Min

Code	R.R.P (inc GST)
CASORC	\$105



Milan Pin Lever Wall Mixer or Shower Diverter Chrome

- 35mm cartridge
- Also available as a Shower Diverter Mixer
- 1/2 turn ceramic disc diverter
- 15 year warranty on cartridge
- 2 year warranty parts and labour

Code	R.R.P (inc GST)
MIWAC (Mixer)	\$115
MISDIC (Diverter)	\$150



Milan 'reverse' Pin Lever Wall Mixer Chrome

- 35mm cartridge
- 15 year warranty on cartridge
- 2 year warranty parts and labour

Code	R.R.P (inc GST)
MIWAREVC	\$115



Milan Wall Spout and Mixer Chrome

- 35mm cartridge
- 5 stars 6L/Min
- 6 star options available
- Reverse handle option available
- Spout length 205mm
- 15 year warranty on cartridge
- 2 year warranty parts and labour

Code	R.R.P (inc GST)
MIWBSC (Straight Spout)	\$210
MIWBSC6S (6 star)	\$210
MIWREVBSC (reverse)	\$210



Milan Wall Bend Spout and Mixer Chrome

- 35mm cartridge
- 5 stars 6L/Min
- 6 star options available
- Reverse handle option available
- Spout length 205mm
- 15 year warranty on cartridge
- 2 year warranty parts and labour

Code	R.R.P (inc GST)
MIBSWBSC	\$210
MIREVBSWBC (reverse)	\$210



Milan Wall Bend Spout with 60mm Plates & Wall Mixer Chrome

- 35mm cartridge
- Matching 60mm round cover plates
- 5 stars 6L/Min
- Reverse handle option available
- 6 star options available
- Spout length 205mm
- 15 year warranty on cartridge
- 2 year warranty parts and labour

Code	R.R.P (inc GST)
MIBSWBS60C	\$210
MIREVBSWBS60C (reverse)	\$210



Milan Pin Basin Mixer Chrome

- 50mm & 100mm extensions available to adjust height
- 15 year warranty on cartridge
- 2 year warranty parts and labour
- 10 years on flexible tails, product replacement only
- 5 stars 5.5L/Min(MIBAC)
- 6 stars 4L/Min(MIBAC6S)
- 35mm cartridge
- PEX tails

Code	R.R.P (inc GST)
MIBAC	\$160
MIBAC6S (6 star)	\$160



Milan Pin Lever Upswept Basin Mixer Chrome

- 50mm & 100mm extensions available to adjust height
- 15 year warranty on cartridge
- 2 year warranty parts and labour
- 10 years on flexible tails, product replacement only
- 35mm cartridge
- PEX tails
- 5 stars 6.0L/Min

Code	R.R.P (inc GST)
MIMIRUBAC	\$160



Milan Pin Lever Curved Spout Basin Mixer

- 50mm & 100mm extensions available to adjust height
- 15 year warranty on cartridge
- 2 year warranty parts and labour
- 10 years on flexible tails, product replacement only
- 35mm cartridge
- PEX tails
- 6 stars 4.0L/Min

Code	R.R.P (inc GST)
MICUBAC	\$160



Milan Basin Mixer Extension Chrome

- Used to create Hi-Rise Tower basin mixer
- Mixer extension with Connector rod and copper extensions
- Available as 50mm or 100mm mixer extension
- Suitable for MIBAC, MICUBAC, MIMIRUBAC, MIMIRUSIC

Code	R.R.P (inc GST)
MIL50SP (50mm)	\$50
MIL100SP (100mm)	\$60



Milan Pin Lever Upswept Sink Mixer Chrome

- 15 year warranty on cartridge
- 2 year warranty parts and labour
- 10 years on flexible tails, product replacement only
- 35mm cartridge
- PEX tails
- 4 stars 7L/Min

Code	R.R.P (inc GST)
MIMIRUSIC	\$170
MIMIRUSIC6S (6 star)	\$170



Milan Pin Lever Sink Mixer Chrome

- 15 year warranty on cartridge
- 2 year warranty parts and labour
- 10 years on flexible tails, product replacement only
- 35mm cartridge
- PEX tails
- 4 stars 6.5L/Min
- Also practical over inset basins

Code	R.R.P (inc GST)
MISIC	\$170



Milan Pin Lever Round Neck Gooseneck Sink Mixer Chrome

- 15 year warranty on cartridge
- 2 year warranty parts and labour
- 10 years on flexible tails, product replacement only
- 35mm cartridge
- PEX tails
- 4 stars 7L/Min

Code	R.R.P (inc GST)
MIGNSIC	\$199
MIGNSIC6S (6 star)	\$199



Milan 6 Star Pin Lever Squared Neck Gooseneck Sink Mixer

- 15 year warranty on cartridge
- 2 year warranty parts and labour
- 10 years on flexible tails, product replacement only
- 35mm cartridge
- PEX tails
- 6 stars 4.5L/Min

Code	R.R.P (inc GST)
MISGNSC	\$199



MI185BSC/MI250BSC



MILBSC

Milan Straight Bath Spout

- Straight spout length 185mm (MI185BSC)
- Straight spout length 250mm (MI250BSC)
- Straight Thick spout length 200mm (MILBSC)
- 10 year product replacement only

Code	R.R.P (inc GST)
MI185BSC	\$60
MI250BSC	\$85
MILBSC	\$105



MISWBSC



MIMIRCU185C

Milan Swivel Bath Spout / Milan Curved Bath Spout Chrome

- Spout length 250mm
- 10 year product replacement only

Code	R.R.P (inc GST)
MISWBSC	\$105
MIMIRCU185C	\$60



Milan Bend Bath Spout Chrome

- Curved spout length 170mm or 230mm
- 10 year product replacement only
- 6 star option available

Code	R.R.P (inc GST)
MI170BBSC	\$85
MI230BBSC	\$105
MI170BBSC6S(6 star)	\$85
MI230BBSC6S(6 star)	\$105



Milan Ceiling Mounted Arm Chrome

- 10 year product replacement only

Code	R.R.P (inc GST)
MILCA150 (150mm)	\$40
MILCA300 (300mm)	\$50
MILCA450 (450mm)	\$65
MILCA600 (600mm)	\$85



MIWMUPSA

MWMSA

Milan Round Wall Mounted Shower Arms Chrome

- 310mm height x 350mm reach (Upswept Shower Arm) MIWMUPSA
- 82mm height x 400mm reach (Mounted Shower Arm) MWMSA
- 10 year product replacement only

Code	R.R.P (inc GST)
MIWMUPSA	\$125
MWMSA	\$105



Milan Shower Head Chrome

- 200mm Chrome plated brass (8mm thick)
- 200mm polished stainless steel (4mm thick)
- 300mm Polished Stainless Steel (4mm thick)
- 10 year product replacement only
- 3 stars 8.5L/Min (MISH200)
- 4 stars 7.0L/Min (MISHTH200)
- 3 stars 9.0L/Min (MISH300)

Code	R.R.P (inc GST)
MISH200 (8mm Brass)	\$105
MISHTH200 (4mm SS)	\$105
MISH300 (4mm SS)	\$195



Milan Round Shower on Rail Chrome

- Metal fixing posts
- Adjustable posts for retro fitting
- 5 stars 6.0L/Min
- 3 function ABS handpiece
- 10 year product replacement only
- 1 year hose product replacement only
- 1 year labour

Code	R.R.P (inc GST)
MISORC	\$165



Milan Round Twin Shower on Rail Chrome

- Top water diverter entry
- 3 function ABS handpiece
- Adjustable bottom post
- 4 stars 8.5L/Min
- 250mm Showerhead
- 10 year product replacement only
- 1 year hose product replacement only
- 1 year labour

Code	R.R.P (inc GST)
MITWSORC	\$575



Milan Water Through Shower on Rail Chrome

- ø20 brass shower tube with brass slider
- Integrated shower elbow entry at top rail post
- 1.5m PVC hose
- Multifunction ABS hand shower
- Chrome finish
- 5 stars 5.5L/Min
- 10 year product replacement only
- 1 year hose product replacement only
- 1 year labour

Code	R.R.P (inc GST)
MWTRHSORC	\$195



Milan Handshower on Bracket Chrome

- Solid brass elbow
- 3 function ABS handpiece
- 4 stars 6.5L/Min
- 10 year product replacement only
- 1 year hose product replacement only
- 1 year labour

Code	R.R.P (inc GST)
MIHSC	\$105



Milan CARE Pin Lever Wall Mixer or Shower Diverter Chrome

- 35mm cartridge
- 160mm Handle
- Also available as a Shower Diverter Mixer
- 1/2 turn ceramic disc diverter
- 15 year warranty on cartridge
- 2 year warranty parts and labour

Code	R.R.P (inc GST)
MIWAC-CARE (Mixer)	\$195
MISDIC-CARE (Diverter)	\$209



Milan CARE Basin Mixer Chrome

- 35mm cartridge
- 160mm Handle
- 15 year warranty on cartridge
- 2 year warranty parts and labour
- 5 stars 5.5L/Min
- PEX tails

Code	R.R.P (inc GST)
MIBAC-CARE	\$189
MIBAC6S-CARE	\$189



Milan CARE Wall & Bend Spout Mixer 60mm Plate Chrome

- 35mm cartridge
- 160mm Handle
- 15 year warranty on cartridge
- 2 year warranty parts and labour
- 5 stars 6.0L/Min
- Spout length 205mm

Code	R.R.P (inc GST)
MIBSWBS60C-CARE	\$299



Milan CARE Gooseneck Sink Mixer Chrome

- 35mm cartridge
- 160mm Handle
- 15 year warranty on cartridge
- 2 year warranty parts and labour
- 4 stars 7.0L/Min
- PEX tails

Code	R.R.P (inc GST)
MIGNSIC-CARE	\$279



Milan CARE Handle Chrome

- 160mm Handle
- MIDISHC-CARE to suit wall/basin/sink mixer (SISIC)
- MIDISHSINK-CARE to suit gooseneck sink mixer
- 2 year warranty

Code	R.R.P (inc GST)
MIDISHC-CARE (wall/basin)	\$99
MIDISHSINKC-CARE(sink)	\$99



Milan Pin Lever Wall Mixer or Shower Diverter Black

- 35mm cartridge
- 1/2 turn ceramic disc diverter
- Matte Black finish
- 2 year warranty parts and labour
- 2 year warranty on Black finish

Code	R.R.P (inc GST)
MIWAC-B (Mixer)	\$135
MISDIC-B (Diverter)	\$190



Milan 'Reverse' Pin Lever Wall Mixer Black

- 35mm cartridge
- Matte Black finish
- 15 year warranty on cartridge
- 2 year warranty parts and labour
- 2 year warranty on Black finish

Code	R.R.P (inc GST)
MIWAREVC-B	\$135



Milan Pin Lever Wall & Spout Mixer Black

- 35mm cartridge
- Reverse handle option available
- 5 stars 6L/Min
- Matte Black finish
- Spout length 205mm
- 15 year warranty on cartridge
- 2 year warranty parts and labour
- 2 year warranty on Black finish

Code	R.R.P (inc GST)
MIWBSC-B	\$295
MIWREVBSC-B (reverse)	\$295



Milan Pin Lever Wall & Bend Spout Mixer Black

- 35mm cartridge
- Reverse handle option available
- 5 stars 6L/Min
- Matte black finish
- Spout length 205mm
- 15 year warranty on cartridge
- 2 year warranty parts and labour
- 2 year warranty on BLACK finish

Code	R.R.P (inc GST)
MIBSWBS-B	\$295
MIREVBSWBS-B (reverse)	\$295



Milan Wall Bend Spout with 60mm Plates & Wall Mixer Black

- 35mm cartridge
- Reverse handle option available
- 5 stars 6L/Min
- Matching 60mm round cover plates
- Matte black finish
- Spout length 205mm
- 15 year warranty on cartridge
- 2 year warranty parts and labour
- 2 year warranty on BLACK finish

Code	R.R.P (inc GST)
MIBSWBS60-B	\$295
MIREVBSWBS60-B (reverse)	\$295



Milan Pin Lever Basin Mixer Black

- 35mm cartridge
- PEX tails
- 5 stars 6.0L/Min
- Also available as 6 star model
- Matte Black finish
- 15 year warranty on cartridge
- 2 year warranty parts and labour
- 2 year warranty on Black finish

- 10 years on flexible tails, product replacement only

Code	R.R.P (inc GST)
MIBAC-B	\$175
MIBAC6S-B	\$175



Milan Pin Lever Curved Spout Basin Mixer Black

- 15 year warranty on cartridge
- 2 year warranty parts and labour
- 2 year warranty on Black finish
- 10 years on flexible tails, product replacement only
- 35mm cartridge
- PEX tails
- 6 stars 4.0L/Min
- Matte Black finish

Code	R.R.P (inc GST)
MICUBA-B	\$175



Milan Basin Mixer Extension Black

- Used to create Hi-Rise Tower basin mixer
- Mixer extension with Connector rod and copper extensions
- Available as 50mm or 100mm mixer extension
- Suitable for **MIBA-B, MICUBA-B**

Code	R.R.P (inc GST)
MIL50SP-B	\$60
MIL100SP-B	\$70



Milan Pin Lever Round Neck Gooseneck Sink Mixer Black

- 15 year warranty on cartridge
- 2 year warranty parts and labour
- 2 year warranty on Black finish
- 10 years on flexible tails, product replacement only
- 35mm cartridge
- PEX tails
- 4 stars 7.0L/Min
- Matte Black finish

Code	R.R.P (inc GST)
MIGNSIC-B	\$250
MIGNSIC6S-B	\$250



Milan Pin Lever Squared Neck Gooseneck Sink Mixer Black

- 15 year warranty on cartridge
- 2 year warranty parts and labour
- 2 year warranty on Black finish
- 10 years on flexible tails, product replacement only
- 35mm cartridge
- PEX tails
- 6 stars 4.5L/Min
- Matte Black finish

Code	R.R.P (inc GST)
MISGNS-B	\$250



Milan round swivel 250mm Bath Spout Black

- Matte Black finish
- 10 year product replacement only
- 2 year warranty on Black finish

Code	R.R.P (inc GST)
MISWBSC-B	\$185



Milan Bath Spout Black

- Matte Black finish
- 185mm (MIST185C-B)
- 200mm Thick Spout (MILBSC-B)
- 10 year product replacement only
- 2 year warranty on Black finish

Code	R.R.P (inc GST)
MIST185C-B	\$85
MILBSC-B	\$125



Milan Bend Bath Spout Black

- Available as 170mm or 230mm
- Matte Black finish
- 10 year product replacement only
- 2 year warranty on Black finish
- 6 star option available

Code	R.R.P (inc GST)
MI170BBS-B	\$75
MI230BBS-B	\$95
MI170BBS6S-B(6 star)	\$140
MI230BBS6S-B(6 star)	\$150



Milan 300mm & 450mm Ceiling Mounted Arm Black

- Matte Black finish
- 10 year product replacement only
- 2 year warranty on Black finish

Code	R.R.P (inc GST)
MILCA300-B	\$90
MILCA450-B	\$105



Milan Round Wall Mounted Shower Arms Black

- 310mm height x 350mm reach (Upswept Shower Arm) MILUPSA-B
- 82mm height x 400mm reach (Mounted Shower Arm) MWMSA400-BL
- Matte black finish
- 10 year product replacement only
- 2 year warranty on BLACK finish

Code	R.R.P (inc GST)
MILUPSA-B	\$165
MWMSA400-BL	\$140



Milan 200mm & 300mm Shower Head Black

- 200mm plated brass (8mm thick) 3 stars 8.5L/Min
- 200mm stainless steel (4mm thick) 4 stars 8.5L/Min
- 300mm stainless steel (4mm thick) 3 stars 9.0L/Min
- Matte Black finish
- 10 year product replacement only
- 2 year warranty on Black finish
- Black rubber nipples

Code	R.R.P (inc GST)
MISH200-B (8mm Brass)	\$169
MISHTH200-B (4mm SS)	\$169
MISHTH300-B (4mm SS)	\$249



Milan Round Shower on Rail Black

- Matte Black finish
- Black rubber nipples
- Metal fixing posts
- Adjustable post for retro fitting
- 5 stars 6.0L/Min
- 3 function ABS handpiece
- 10 year product replacement only
- 2 year warranty on Black finish
- 1 year hose product replacement only

Code	R.R.P (inc GST)
MISOR-BL	\$210



Milan Round Twin Shower on Rail Black

- Matte Black finish
- 4 stars 8.5L/Min
- Black rubber nipples
- 250mm Showerhead
- ABS handpiece
- 3 function ABS handpiece
- Top water diverter entry
- 10 year product replacement only
- 2 year warranty on Black finish
- 1 year hose product replacement only

Code	R.R.P (inc GST)
MITWSOR-B	\$615



Milan Water Through Shower on Rail Black

- 5 stars 5.5L/Min
- ø20 brass shower tube with brass slider
- Integrated shower elbow entry at top rail post
- 1.5m PVC hose
- Multifunction ABS hand shower
- Matte black finish
- Black rubber nipples
- 10 year product replacement only
- 2 year warranty on BLACK finish
- 1 year hose product replacement only

Code	R.R.P (inc GST)
MWTRHSOR-B	\$210



Milan Handshower on Bracket Black

- 3 function ABS handpiece
- Matte black finish
- 3 stars 9.0L/Min
- 10 year product replacement only
- 2 year warranty on BLACK finish
- 1 year hose product replacement only

Code	R.R.P (inc GST)
MIHS-B	\$155



Milan CARE Wall Mixer Black

- 35mm cartridge
- 160mm Handle
- Also available as a Shower Diverter Mixer
- 1/2 turn ceramic disc diverter
- 15 year warranty on cartridge
- 2 year warranty parts and labour

Code	R.R.P (inc GST)
MIWAC-BCARE(Mixer)	\$215
MISDIC-BCARE(Diverter)	\$249



Milan CARE Basin Mixer Black

- 35mm cartridge
- 160mm Handle
- 15 year warranty on cartridge
- 2 year warranty parts and labour
- 4 stars 8.5L/Min

Code	R.R.P (inc GST)
MIBAC-BCARE	\$220
MIBAC6S-BCARE	\$220



Milan CARE Wall & Bend Spout Mixer 60mm Plate Black

- 35mm cartridge
- 160mm Handle
- 15 year warranty on cartridge
- 2 year warranty parts and labour

Code	R.R.P (inc GST)
MIBSWBS60-BCARE	\$330



Milan CARE Gooseneck Sink Mixer Black

- 35mm cartridge
- 160mm Handle
- 15 year warranty on cartridge
- 2 year warranty parts and labour

Code	R.R.P (inc GST)
MIGNSIC-BCARE	\$310



Milan CARE Handle Black

- MIDISH-BCARE to suit wall/basin mixer
- MIDISHSINK-BCARE to suit gooseneck sink mixer
- 2 year warranty
- 160mm Handle

Code	R.R.P (inc GST)
MIDISH-BCARE (wall/basin)	\$115
MIDISHSINK-BCARE (sink)	\$115



Milan Wall Mixer Brushed Nickel

- 35mm cartridge
- Brushed Nickel finish
- 2 year warranty on Nickel Finish

Code	R.R.P (inc GST)
MIWA-NI (Mixer)	\$150
MIWAREV-NI (Reverse)	\$150



Milan Basin Mixer Brushed Nickel Mixer Extension Brushed Nickel

- 35mm cartridge
- Mixer extension with Connector rod and copper extensions
- 50mm or 100mm mixer extension (**SOLD SEPERATELY**)
- Suitable for **MIBA6S-NI**
- Brushed Nickel finish
- 15 year warranty on cartridge
- 2 year warranty parts and labour
- 2 year warranty on Nickel Finish

Code	R.R.P (inc GST)
MIBA6S-NI	\$190
MIL50SP-NI (50mm)	\$70
MIL100SP-NI (100mm)	\$80



Milan Wall & Spout Mixer Brushed Nickel

- 35mm cartridge
- 5 stars 6L/Min
- Brushed Nickel finish
- Spout length 205mm
- 15 year warranty on cartridge
- 2 year warranty parts and labour
- 2 year warranty on Nickel Finish
- Reverse handle option available

Code	R.R.P (inc GST)
MIWBS-NI	\$315
MIWREVBBS-NI (Reverse)	\$315



Milan Wall & Bend Spout Mixer Brushed Nickel

- 35mm cartridge
- 5 stars 6L/Min
- Brushed Nickel finish
- Spout length 205mm
- 15 year warranty on cartridge
- 2 year warranty parts and labour
- 2 year warranty on Nickel Finish
- Reverse handle option available

Code	R.R.P (inc GST)
MIBSWBS-NI	\$315
MIREVBWSBS-NI (Reverse)	\$315



Milan 60mm Wall Plate & Bend Spout Mixer Brushed Nickel

- 35mm cartridge
- Matching 60mm round cover plates
- 5 stars 6L/Min
- Brushed Nickel finish
- Spout length 205mm
- 15 year warranty on cartridge
- 2 year warranty parts and labour
- 2 year warranty on Nickel Finish
- Reverse handle option available

Code	R.R.P (inc GST)
MIBSWBS60-NI	\$315
MIREVBWSBS60-NI (Reverse)	\$315



Milan Round Gooseneck Sink Mixer Brushed Nickel

- 35mm cartridge
- PEX tails
- 5 stars 6.0L/Min
- Also available as 6 star model
- Brushed Nickel finish
- 15 year warranty on cartridge
- 2 year warranty parts and labour

- 10 years on flexible tails, product replacement only
- 2 year warranty on Nickel Finish

Code	R.R.P (inc GST)
MIGNSI-NI	\$270
MIGNSI6S-NI	\$270



Milan Swivel Bath Spout Brushed Nickel

- 10 year product replacement only
- 2 year warranty on Nickel Finish

Code	R.R.P (inc GST)
MISWBS-NI	\$200



Milan 400mm Wall Shower Arm Brushed Nickel

- 10 year product replacement only
- 2 year warranty on Nickel Finish

Code	R.R.P (inc GST)
MWMSA-NI	\$155



Milan 200mm Thin 4mm Shower Head Brushed Nickel

- 10 year product replacement only
- 4mm thin Stainless steel
- 2 year warranty on Nickel Finish

Code	R.R.P (inc GST)
MISHTH200-NI	\$205



Milan 300mm ceiling Mounted Arm Brushed Nickel

- 10 year product replacement only
- 2 year warranty on Nickel Finish

Code	R.R.P (inc GST)
MILCA300-NI	\$125



Milan Handshower On Rail Brushed Nickel

- Metal fixing posts
- Adjustable post for retro fitting
- 5 stars 6.0L/Min
- 3 function ABS handpiece
- 10 year product replacement only
- 2 year warranty on Nickel Finish
- 1 year hose product replacement only

Code	R.R.P (inc GST)
MISOR-NI	\$230



Milan Twin Shower On Rail Brushed Nickel

- 4 stars 8.5L/Min
- ABS handpiece
- Top water diverter entry
- 250mm Showhead
- 10 year product replacement only
- 2 year warranty on Nickel Finish
- 1 year hose product replacement only

Code	R.R.P (inc GST)
MITWSOR-NI	\$680



Milan Wall Mixer Gun Metal

- 35mm cartridge
- Gun Metal finish
- 2 year warranty on Gun Metal Finish

Code	R.R.P (inc GST)
MIWA-GM (Mixer)	\$169
MIWAREV-GM (Reverse)	\$169



**Milan Basin Mixer Gun Metal
Mixer Extension Gun Metal**

- 35mm cartridge
- Mixer extension with Connector rod and copper extensions
- 50mm or 100mm mixer extension (**SOLD SEPERATELY**)
- Suitable for **MIBA6S-GM**
- Gun Metal finish
- 15 year warranty on cartridge
- 2 year warranty parts and labour
- 2 year warranty on Gun Metal
- 6 stars 4L/Min(MIBA6S-GM)

Code	R.R.P (inc GST)
MIBA6S-GM	\$215
MIL50SP-GM (50mm)	\$70
MIL100SP-GM (100mm)	\$80



Milan Wall & Spout Mixer Gun Metal

- 35mm cartridge
- 5 stars 6L/Min
- Gun Metal finish
- Spout length 205mm
- 15 year warranty on cartridge
- 2 year warranty parts and labour
- 2 year warranty on Gun Metal Finish
- Reverse handle option available

Code	R.R.P (inc GST)
MIWBS-GM	\$365
MIWREVBS-GM (Reverse)	\$365



Milan Wall & Bend Spout Mixer Gun Metal

- 35mm cartridge
- 5 stars 6L/Min
- Gun Metal finish
- Spout length 205mm
- 15 year warranty on cartridge
- 2 year warranty parts and labour
- 2 year warranty on Gun Metal Finish
- Reverse handle option available

Code	R.R.P (inc GST)
MIBSWBS-GM	\$365
MIREVBSWBS-GM (Reverse)	\$365



Milan Wall Bend Spout with 60mm Plates & Wall Mixer Gun Metal

- 35mm cartridge
- Matching 60mm round cover plates
- 5 stars 6L/Min
- Gun Metal finish
- Spout length 205mm
- 15 year warranty on cartridge
- 2 year warranty parts and labour
- 2 year warranty on Gun Metal Finish
- Reverse handle option available

Code	R.R.P (inc GST)
MIBSWBS60-GM	\$365
MIREVBSWBS60-GM (Reverse)	\$365



Milan Round Gooseneck Sink Mixer Gun Metal

- 35mm cartridge
- PEX tails
- 5 stars 6.0L/Min
- Also available as 6 star model
- Gun Metal finish
- 15 year warranty on cartridge
- 2 year warranty parts and labour

- 10 years on flexible tails, product replacement only
- 2 year warranty on Gun Metal Finish

Code	R.R.P (inc GST)
MIGNSI-GM	\$310
MIGNSI6S-GM	\$310



Milan Swivel Bath Spout Gun Metal

- Gun Metal finish
- 10 year product replacement only
- 2 year warranty on Gun Metal finish

Code	R.R.P (inc GST)
MISWBS-GM	\$230



Milan 400mm Wall Shower Arm Gun Metal

- Gun Metal finish
- 10 year product replacement only
- 2 year warranty on Gun Metal finish

Code	R.R.P (inc GST)
MWMSA-GM	\$180



Milan 200mm Thin 4mm Shower Head Gun Metal

- 10 year product replacement only
- 4mm thin
- 2 year warranty on Gun Metal finish

Code	R.R.P (inc GST)
MISHTH200-GM	\$235



Milan 300mm Ceiling Mounted Arm Gun Metal

- 10 year product replacement only
- 2 year warranty on Gun Metal finish

Code	R.R.P (inc GST)
MILCA300-GM	\$145



Milan Handshower On Rail Gun Metal

- Metal fixing posts
- Adjustable post for retro fitting
- 5 stars 6.0L/Min
- 3 function ABS handpiece
- 10 year product replacement only
- 2 year warranty on Gun Metal finish
- 1 year hose product replacement only

Code	R.R.P (inc GST)
MISOR-GM	\$265



Milan Twin Shower On Rail Gun Metal

- 4 stars 8.5L/Min
- ABS handpiece
- Top water diverter entry
- 10 year product replacement only
- 250mm Showerhead
- 2 year warranty on Gun Metal finish
- 1 year hose product replacement only

Code	R.R.P (inc GST)
MITWSOR-GM	\$780



Siera Wall Mixer or Shower Diverter Chrome

- 35mm cartridge
- 1/2 turn ceramic disc diverter
- 15 year warranty on cartridge
- 2 year warranty parts and labour

Code	R.R.P (inc GST)
SIWAC (Mixer)	\$115
SISDIC (Diverter)	\$150



Siera 'Reverse' Pin Lever Wall Mixer Chrome

- 35mm cartridge
- 15 year warranty on cartridge
- 2 year warranty parts and labour

Code	R.R.P (inc GST)
SIWAREVC	\$115

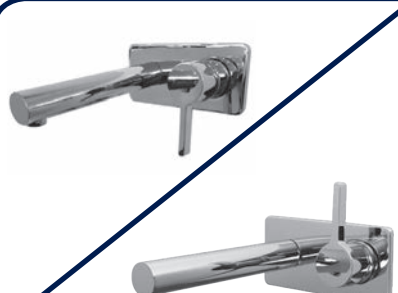

Siera Wall & Spout Mixer Chrome

- 35mm cartridge
- 5 stars 6.0L/Min
- Spout length 205mm
- 15 year warranty on cartridge
- 2 year warranty parts and labour
- Reverse handle option available

Code	R.R.P (inc GST)
SIWBS	\$210
SIREVWBS (Reverse)	\$210



Siera Round Wall & Bend Spout Mixer Chrome

- 15 year warranty on cartridge
- 2 year warranty parts and labour
- 35mm cartridge
- Spout length 205mm
- 5 stars 6.0L/Min
- Reverse handle option available

Code	R.R.P (inc GST)
SIBSWBS	\$210
SIREVBSWBS (Reverse)	\$210



Siera Wall Bend Spout with 60mm Plates & Wall Mixer Chrome

- 15 year warranty on cartridge
- 2 year warranty parts and labour
- 35mm cartridge
- Spout length 205mm
- 5 stars 6.0L/Min
- Reverse handle option available

Code	R.R.P (inc GST)
SIBSWBS60C	\$210
SIREVBSWBS60C (Reverse)	\$210



Siera Basin Mixer Chrome

- 50mm & 100mm extensions available to adjust height
- 15 year warranty on cartridge
- 2 year warranty parts and labour
- 10 years on flexible tails, product replacement only
- 35mm cartridge
- PEX tails
- 5 stars 5.5L/Min

Code	R.R.P (inc GST)
SIBAC	\$160



Siera Curved Spout Basin Mixer Chrome

- 50mm & 100mm extensions available to adjust height
- 15 year warranty on cartridge
- 2 year warranty parts and labour
- 10 years on flexible tails, product replacement only
- 35mm cartridge
- PEX tails
- 6 stars 4.0L/Min

Code	R.R.P (inc GST)
SICUBAC	\$160



Siera Basin Mixer Extension Chrome

- Used to create Hi-Rise Tower basin mixer
- Spacer mixer with Connector rod and copper extensions
- Available as 50mm or 100mm mixer extension
- Suitable for **SIBAC**, **SICUBAC**.

Code	R.R.P (inc GST)
MIL50SP (50mm)	\$50
MIL100SP (100mm)	\$60



Siera Round Neck Gooseneck Sink Mixer Chrome Siera Squared Neck Gooseneck Sink Mixer Chrome

- 15 year warranty on cartridge
- 2 year warranty parts and labour
- 10 years on flexible tails, product replacement only
- 35mm cartridge
- PEX tails
- 4 stars 7.0L/Min (SIGNSIC)
- 6 stars 4.5L/Min (SIGNSC)

Code	R.R.P (inc GST)
SIGNSIC (Round Neck)	\$199
SIGNSC (Squared Neck)	\$199



Siera Standard Sink Mixer Chrome

- 15 year warranty on cartridge
- 2 year warranty parts and labour
- 10 years on flexible tails, product replacement only
- 35mm cartridge
- PEX tails
- 4 stars 6.5L/Min

Code	R.R.P (inc GST)
SISIC	\$170



Siera Wall Mixer or Shower Diverter Black

- 15 year warranty on cartridge
- 10 years on flexible tails, product replacement only
- 2 year warranty parts and labour
- 2 year warranty on Black finish
- 35mm cartridge
- 1/2 turn ceramic disc diverter

Code	R.R.P (inc GST)
SIWA-B (Mixer)	\$135
SISDI-B (Diverter)	\$190



Siera 'Reverse' Pin Lever Wall Mixer Black

- 35mm cartridge
- 15 year warranty on cartridge
- 10 years on flexible tails, product replacement only
- 2 year warranty parts and labour
- 2 year warranty on Black finish
- Reverse handle option available

Code	R.R.P (inc GST)
SIWAREV-B	\$135



Siera Wall & Spout Mixer Black

- 15 year warranty on cartridge
- 2 year warranty parts and labour
- 2 year warranty on Black finish
- 35mm cartridge
- 5 stars 6.0L/Min
- Spout length 205mm
- Reverse handle option available

Code	R.R.P (inc GST)
SIWBS-B	\$295
SIREVWBS-B (Reverse)	\$295



Siera Round Wall & Bend Spout Mixer Black

- 15 year warranty on cartridge
- 2 year warranty parts and labour
- 2 year warranty on Black finish
- 5 stars 6.0L/Min
- 35mm cartridge
- Reverse handle option available
- Spout length 205mm

Code	R.R.P (inc GST)
SIBSWBS-B	\$295
SIREVBSWBS-B (Reverse)	\$295



Siera Round Wall Bend Spout with 60mm Plates & Wall Mixer Black

- 15 year warranty on cartridge
- 2 year warranty parts and labour
- 2 year warranty on Black finish
- 5 stars 6.0L/Min
- 35mm cartridge
- Reverse handle option available
- Spout length 205mm

Code	R.R.P (inc GST)
SIBSWBS60-B	\$295
SIREVBSWBS60-B (Reverse)	\$295



Siera Basin Mixer Black

- 50mm & 100mm extensions available to adjust height
- 15 year warranty on cartridge
- 10 years on flexible tails, product replacement only
- 2 year warranty parts and labour
- 2 year warranty on Black finish
- 35mm cartridge
- PEX tails
- 5 stars 5.5L/Min

Code	R.R.P (inc GST)
SIBA-B	\$175



Siera Curved Spout Basin Mixer Black

- 50mm & 100mm extensions available to adjust height
- 15 year warranty on cartridge
- 10 years on flexible tails, product replacement only
- 2 year warranty parts and labour
- 2 year warranty on Black finish
- 35mm cartridge
- PEX tails
- 6 stars 4.0L/Min

Code	R.R.P (inc GST)
SICUBA-B	\$175



Siera Basin Mixer Extension Black

- Spacer extension with Connector rod and copper extensions
- Available as 50mm or 100mm spacer extension
- Suitable for **SIBA-B**, **SICUBA-B**

Code	R.R.P (inc GST)
MIL50SP-B	\$60
MIL100SP-B	\$70



Siera Round Neck Gooseneck Sink Mixer Black

- 15 year warranty on cartridge
- 10 years on flexible tails, product replacement only
- 2 year warranty parts and labour
- 2 year warranty on Black finish
- 35mm cartridge
- PEX tails
- 4 stars 7.0L/Min

Code	R.R.P (inc GST)
SIGNSI-B	\$250



Siera Squared Neck Gooseneck Sink Mixer Black

- 15 year warranty on cartridge
- 10 years on flexible tails, product replacement only
- 2 year warranty parts and labour
- 2 year warranty on Black finish
- 35mm cartridge
- PEX tails
- 6 stars 4.5L/Min

Code	R.R.P (inc GST)
SISGNS-B	\$250



Siera Wall Mixer Brushed Nickel

- 15 year warranty on cartridge
- 2 year warranty parts and labour
- 2 year warranty on Brushed Nickel finish
- 35mm cartridge

Code	R.R.P (inc GST)
SIWA-NI (Mixer)	\$150



Siera 'Reverse' Pin Lever Wall Mixer Brushed Nickel

- 35mm cartridge
- 15 year warranty on cartridge
- 10 years on flexible tails, product replacement only
- 2 year warranty parts and labour
- 2 year warranty on Brushed Nickel finish

Code	R.R.P (inc GST)
SIWAREV-NI	\$150



Siera Basin Mixer Brushed Nickel

- 15 year warranty on cartridge
- 10 years on flexible tails, product replacement only
- 2 year warranty parts and labour
- 2 year warranty on Brushed Nickel finish
- 35mm cartridge
- 5 stars 6L/Min

Code	R.R.P (inc GST)
SIBA-NI	\$190



Siera Basin Mixer Extension Brushed Nickel

- Mixer extension with Connector rod and copper extensions
- Available as 50mm or 100mm mixer extension
- 2 year warranty on Brushed Nickel finish
- Suitable for **SIBA-B**

Code	R.R.P (inc GST)
MIL50SP-NI	\$70
MIL100SP-NI	\$80

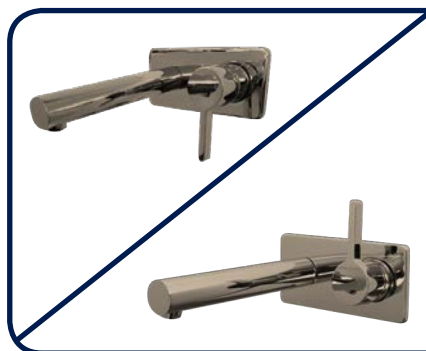

Siera Wall & Spout Mixer Brushed Nickel

- 15 year warranty on cartridge
- 2 year warranty parts and labour
- 2 year warranty on Brushed Nickel finish
- 35mm cartridge
- Reverse handle option available
- 5 stars 6L/Min

Code	R.R.P (inc GST)
SIWBS-NI	\$315
SIREVWBS-NI (Reverse)	\$315



Siera Wall & Bend Spout Mixer Brushed Nickel

- 15 year warranty on cartridge
- 2 year warranty parts and labour
- 2 year warranty on Brushed Nickel finish
- 35mm cartridge
- Reverse handle option available
- 5 stars 6L/Min

Code	R.R.P (inc GST)
SIBSWBS-NI	\$315
SIREVBSWBS-NI (Reverse)	\$315



Siera Wall & Bend Spout Mixer 60mm Plate Brushed Nickel

- 15 year warranty on cartridge
- 2 year warranty parts and labour
- 2 year warranty on Brushed Nickel finish
- 35mm cartridge
- Reverse handle option available
- 5 stars 6L/Min

Code	R.R.P (inc GST)
SIBSWBS60-NI	\$315
SIREVBSWBS60-NI (Reverse)	\$315



Siera Round Neck Gooseneck Sink Mixer Brushed Nickel

- 15 year warranty on cartridge
- 10 years on flexible tails, product replacement only
- 2 year warranty parts and labour
- 2 year warranty on Brushed Nickel finish
- 35mm cartridge
- 4 stars 7.0L/Min

Code	R.R.P (inc GST)
SIGNSI-NI	\$270



Siera Wall Mixer Gun Metal

- 15 year warranty on cartridge
- 2 year warranty parts and labour
- 2 year warranty on Gun Metal finish
- 35mm cartridge

Code	R.R.P (inc GST)
SIWA-GM	\$169



Siera 'Reverse' Pin Lever Wall Mixer Gun Metal

- 35mm cartridge
- 15 year warranty on cartridge
- 10 years on flexible tails, product replacement only
- 2 year warranty parts and labour
- 2 year warranty on Gun Metal finish

Code	R.R.P (inc GST)
SIWAREV-GM	\$169



Siera Basin Mixer Gun Metal

- 15 year warranty on cartridge
- 10 years on flexible tails, product replacement only
- 2 year warranty parts and labour
- 2 year warranty on Gun Metal finish
- 35mm cartridge
- 5 stars 6L/Min

Code	R.R.P (inc GST)
SIBA-GM	\$215



Siera Basin Mixer Extension Gun Metal

- Mixer extension with Connector rod and copper extensions
- Available as 50mm or 100mm mixer extension
- Suitable for **SIBA-B**
- 2 year warranty on Gun Metal finish

Code	R.R.P (inc GST)
MIL50SP-GM	\$70
MIL100SP-GM	\$80

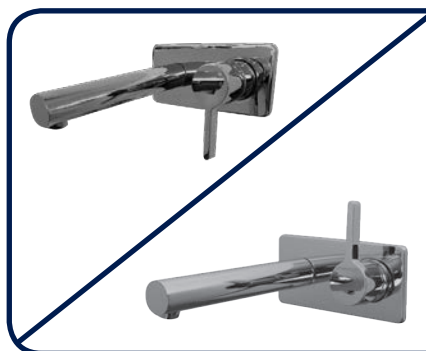

Siera Wall & Spout Mixer Gun Metal

- 15 year warranty on cartridge
- 2 year warranty parts and labour
- 2 year warranty on Gun Metal finish
- 35mm cartridge
- Spout length 205mm
- Reverse handle option available
- 5 stars 6.0L/Min

Code	R.R.P (inc GST)
SIWBS-GM	\$365
SIREVWBS-GM (Reverse)	\$365



Siera Wall & Bend Spout Mixer Gun Metal

- 15 year warranty on cartridge
- 2 year warranty parts and labour
- 2 year warranty on Gun Metal finish
- 35mm cartridge
- Spout length 205mm
- Reverse handle option available
- 5 stars 6.0L/Min

Code	R.R.P (inc GST)
SIBSWBS-GM	\$365
SIREVBSWBS-GM (Reverse)	\$365



Siera Wall & Bend Spout Mixer 60mm Plate Gun Metal

- 15 year warranty on cartridge
- 2 year warranty parts and labour
- 2 year warranty on Gun Metal finish
- 35mm cartridge
- Spout length 205mm
- Reverse handle option available
- 5 stars 6.0L/Min

Code	R.R.P (inc GST)
SIBSWBS60-GM	\$365
SIREVBSWBS60-GM (Reverse)	\$365



Siera Round Neck Gooseneck Sink Mixer Gun Metal

- 15 year warranty on cartridge
- 10 years on flexible tails, product replacement only
- 2 year warranty parts and labour
- 2 year warranty on Gun Metal finish
- 35mm cartridge
- 4 stars 7.0L/Min

Code	R.R.P (inc GST)
SIGNSI-GM	\$310



Elba Square Wall Mixer or Shower Diverter Chrome

- 35mm cartridge
- 1/2 turn ceramic disc diverter
- 7 year warranty on cartridge
- 1 year warranty parts and labour

Code	R.R.P (inc GST)
ELWAC (Mixer)	\$115
ELWDIC (Diverter)	\$165



Elba Wall Spout and Mixer Chrome

- 35mm cartridge
- 5 stars 5.5L/Min
- Spout length 200mm
- 7 year warranty on cartridge
- 1 year warranty parts and labour

Code	R.R.P (inc GST)
ELWBSC	\$230



Elba Square Basin Mixer Chrome

- 7 year warranty on cartridge
- 1 year warranty parts and labour
- 10 years on flexible tails, product replacement only
- 35mm cartridge
- PEX tails
- 5 stars 6.0L/Min

Code	R.R.P (inc GST)
ELBAC2	\$165



Elba Basin Mixer Extension Chrome

- Used to create Hi-Rise Tower basin mixer
- Mixer extension with Connector rod and copper extensions
- Available as 50mm or 100mm mixer extension
- Suitable for **ELBAC2**

Code	R.R.P (inc GST)
EL50SP	\$70
EL100SP	\$80



Elba Square Gooseneck Sink Mixer Chrome

- 7 year warranty on cartridge
- 1 year warranty parts and labour
- 10 years on flexible tails, product replacement only
- 35mm cartridge
- PEX tails
- 4 stars 6.5L/Min

Code	R.R.P (inc GST)
ELGNSIC	\$210



Elba Square 185mm Bath Spout Chrome

- Spout length 185mm
- 10 year product replacement only

Code	R.R.P (inc GST)
ELBSC	\$80



Elba Swivel Bath Spout Chrome

- Spout length 260mm
- 10 year product replacement only

Code	R.R.P (inc GST)
ELBSWBSC	\$130



Elba Ceiling Shower Arm Chrome

- Available in 150mm, 300mm, 400mm, 600mm
- 10 year product replacement only

Code	R.R.P (inc GST)
ELCA150	\$60
ELCA300	\$70
ELCA400	\$80
ELCA600	\$115



Elba 400mm Wall Shower Arm Chrome

- 10 year product replacement only

Code	R.R.P (inc GST)
ELWSA400	\$115



Elba Upswept Shower Arm Chrome

- 10 year product replacement only

Code	R.R.P (inc GST)
ELWMUPSA	\$185



Elba Handshower on Bracket Chrome

- Single function handpiece
- Solid brass elbow
- 3 stars 9L/Min
- 10 year product replacement only
- 1 year hose product replacement only

Code	R.R.P (inc GST)
ELHSC	\$125



Elba 4mm Thin Square Shower Head Chrome

- 200mm Polished Stainless Steel (4mm Thin)
- 300mm Polished Stainless Steel (4mm Thin)
- 10 year product replacement only
- 4 stars 9.0L/Min (ELSHTH200)
- 3 stars 8.5L/Min (ELSHTH300)

Code	R.R.P (inc GST)
ELSHTH200 (200mm)	\$125
ELSHTH300 (300mm)	\$225



Elba Single Function Shower On Rail Chrome

- 4 stars 7.0L/Min
- Complete metal construction
- ABS single function handpiece
- 10 year product replacement only
- 1 year hose product replacement only
- 1 year labour

Code	R.R.P (inc GST)
ELSOR	\$180



Elba Twin Head Shower On Rail Chrome

- Top water diverter entry
- Polished stainless head
- Adjustable bottom fixing post
- ABS 3 function hand piece
- 250mm Showerhead
- 4 stars 7.0L/Min
- 10 year product replacement only
- 1 year hose product replacement only
- 1 year labour

Code	R.R.P (inc GST)
ELTWSOR	\$575



Elba Square Wall Mixer or Shower Diverter Black

- 35mm cartridge
- 5 stars 6.0L/Min
- Also available as a Shower Diverter Mixer
- Matte Black finish
- Half Turn Ceramic disc diverter
- 7 year warranty on cartridge
- 1 year warranty on parts and labour
- 2 year warranty on Black finish

Code	R.R.P (inc GST)
ELWAC-B (Mixer)	\$145
ELWDIC-B (Diverter)	\$190



Elba Wall Spout and Mixer Black

- 35mm cartridge
- 7 year warranty on cartridge
- 1 year warranty on parts and labour
- 2 year warranty on colour finish
- 5 stars 5.5L/Min
- Spout length 200mm
- Matte Black finish

Code	R.R.P (inc GST)
ELWBSC-B	\$295



Elba Square Basin Mixer Black

- 7 year warranty on cartridge
- 1 year warranty parts and labour
- 2 year warranty on Black finish
- 10 years on flexible tails, product replacement only
- 35mm cartridge
- PEX tails
- 5 stars 6.0L/Min
- Matte Black finish

Code	R.R.P (inc GST)
ELBAC2-B	\$250



Elba Square Gooseneck Sink Mixer Black

- 7 year warranty on cartridge
- 1 year warranty parts and labour
- 2 year warranty on Black finish
- 10 years on flexible tails, product replacement only
- 35mm cartridge
- PEX tails
- 4 stars 6.5L/Min
- Matte Black finish

Code	R.R.P (inc GST)
ELGNSI-B	\$305



Elba Basin Mixer Extension Black

- Spacer extension with Connector rod and copper extensions
- Available as 50mm or 100mm spacer extension
- 2 year warranty on Black finish
- Suitable for ELBAC2-B

Code	R.R.P (inc GST)
EL50SP-B	\$80
EL100SP-B	\$90



Elba 185mm Bath Spout Black

- Spout length 185mm
- 10 year product replacement only
- 2 year warranty on Black finish
- 1 year labour

Code	R.R.P (inc GST)
ELBS-B	\$115



Elba 300mm & 400mm Ceiling Mounted Arm Black

- Matte Black finish
- 10 year product replacement only
- 2 year warranty on Black finish
- 1 year labour

Code	R.R.P (inc GST)
ELCA300-B	\$90
ELCA400-B	\$105



Elba Square 400mm Wall Shower Arm Black

- Matte Black finish
- 10 year product replacement only
- 2 year warranty on Black finish
- 1 year labour

Code	R.R.P (inc GST)
ELWSA400-B	\$130



Elba Square Upswept Shower Arm Black

- Matte Black finish
- 10 year product replacement only
- 2 year warranty on Black finish
- 1 year labour

Code	R.R.P (inc GST)
ELWMUPSA-B	\$250



Elba 4 mm Thin 200mm Shower Head Black

- Black nipples
- Matte Black finish
- 10 year product replacement only
- 2 year warranty on Black finish
- 1 year labour
- 4 stars 9.0L/Min (ELSHTH200-B)
- 3 stars 8.5L/Min (ELSHTH300-B)

Code	R.R.P (inc GST)
ELSHTH200-B	\$178
ELSHTH300-B	\$293



Elba Single Function Shower on Rail Black

- 3 stars 9.0L/Min
- Matte Black finish
- Single function ABS hand piece
- Metal rail and posts
- Black rubber nipples
- 10 year product replacement only
- 2 year warranty on Black finish
- 1 year labour

Code	R.R.P (inc GST)
ELSOR-B	\$229



Elba Square Twin Shower on Rail Black

- 3 stars 9.0L/Min
- Matte Black finish
- ABS 3 function hand piece
- Black stainless head
- 250mm Showerhead
- Top water diverter entry
- Black rubber nipples
- 10 year product replacement only
- 2 year warranty on Black finish
- 1 year labour

Code	R.R.P (inc GST)
ELTWSOR-B	\$651



Positano Wall Mixer or Shower Diverter Chrome

- 35mm cartridge
- Also available as a Shower Diverter Mixer with 1/2 turn ceramic diverter
- 15 year warranty on cartridge
- 2 year warranty on parts and labour

Code	R.R.P (inc GST)
POSWAC (Mixer)	\$135
POSWDIC (Diverter)	\$209



Positano Wall and Spout Mixer Chrome

- 15 year warranty on cartridge
- 2 year warranty parts and labour
- 35mm cartridge
- Neoppearl recessed aerator
- 5 stars 5.0L/Min
- Spout length 200mm

Code	R.R.P (inc GST)
POSWBSC	\$241



Positano Basin Mixer Chrome

- 15 year warranty on cartridge
- 2 year warranty parts and labour
- 10 years on flexible tails, product replacement only
- 35mm Kerox cartridge
- PEX tails
- Neoppearl recessed aerator
- 5 stars 5.0L/Min

Code	R.R.P (inc GST)
POSBAC	\$198



Positano High Rise Basin Mixer Chrome

- 15 year warranty on cartridge
- 2 year warranty parts and labour
- 10 years on flexible tails, product replacement only
- 35mm Kerox cartridge
- PEX tails
- Neoppearl recessed aerator
- 5 stars 5.0L/Min

Code	R.R.P (inc GST)
POSTOBAC	\$262



Positano Sink Mixer Chrome

- 15 year warranty on cartridge
- 2 year warranty parts and labour
- 10 years on flexible tails, product replacement only
- 35mm cartridge
- PEX tails
- Neoppearl recessed aerator
- 4 stars 7.5L/Min

Code	R.R.P (inc GST)
POSSIC	\$262



Positano Handshower on Rail Chrome

- 10 year product replacement only
- 1 year hose product replacement only
- 1 year labour
- Solid brass rail
- 3 function ABS hand piece
- 3 Star 8.0L/min

Code	R.R.P (inc GST)
POSSORC	\$305



Positano Wall Mixer or Shower Diverter Black

- 35mm cartridge
- Matte Black finish
- Also available as a Shower Diverter Mixer with 1/2 turn ceramic diverter
- 15 year warranty on cartridge
- 2 year warranty parts and labour
- 2 year warranty on Black finish

Code	R.R.P (inc GST)
POSWA-B (Mixer)	\$178
POSWDI-B (Diverter)	\$240



Positano Wall & Spout Mixer Black

- 15 year warranty on cartridge
- 2 year warranty parts and labour
- 2 year warranty on Black finish
- 35mm cartridge
- Neoparl recessed aerator
- 5 stars 5.0L/Min
- Matte Black finish
- Spout length 200mm

Code	R.R.P (inc GST)
POSWBS-B	\$272



Positano Basin Mixer Black

- 15 year warranty on cartridge
- 2 year warranty parts and labour
- 2 year warranty on Black finish
- 10 years on flexible tails, product replacement only
- 35mm Kerox cartridge
- PEX tails
- Neoparl recessed aerator
- 5 stars 5.0L/Min

Code	R.R.P (inc GST)
POSBA-B	\$262



Positano High Rise Basin Mixer Black

- 15 year warranty on cartridge
- 2 year warranty parts and labour
- 2 year warranty on Black finish
- 10 years on flexible tails, product replacement only
- 35mm Kerox cartridge
- PEX tails
- Neoparl recessed aerator
- 5 stars 5.0L/Min

Code	R.R.P (inc GST)
POSTOBA-B	\$304



Positano Sink Mixer Black

- 15 year warranty on cartridge
- 2 year warranty parts and labour
- 2 year warranty on Black finish
- 10 years on flexible tails, product replacement only
- 35mm cartridge
- PEX tails
- Neoparl recessed aerator
- 4 stars 7.5L/Min

Code	R.R.P (inc GST)
POSSI-B	\$283



Positano Handshower on Rail Black

- 10 year product replacement only
- 2 year warranty on Black finish
- 1 year hose product replacement only
- 1 year labour
- Solid brass rail
- 3 function ABS hand piece
- 3 Star 8.0L/min
- Black nipples

Code	R.R.P (inc GST)
POSSOR-B	\$346



Belucci Sink Mixer with Flexi Hose Black Hose

- Manufactured from 304 Stainless Steel
- Brushed Stainless Steel Finish
- Great alternative to Brushed Nickel Brass construction tapware
- PEX Flexible Tails
- Lifetime Warranty Construction of the Tap Body
- Lead Free Tap Body
- 2 Function Pattern Spray Head
- Easy fix fixing kit
- 100mm extension thread (ideal for thicker substrates)
- WELS 5 stars 6.0L/min
- 15 year warranty on cartridge
- Labour 2 Year In House Warranty

Code	R.R.P (inc GST)
BELSISS	\$539



Valerno Pull Out Sink Mixer Brushed Stainless Steel

- Manufactured from 304 Stainless Steel
- Brushed Stainless Steel Finish
- Lead Free Tap Body
- 35mm Cold Start Cartridge Position
- 2 Function Pattern Spray Head
- Flexible Ball Joint Spray Head – Stainless Steel
- Great alternative to Brushed Nickel Brass construction tapware
- Lifetime Warranty Construction of the Tap Body
- Cartridge – 15 Year Product Replacement Warranty
- Finish – Lifetime Warranty
- Labour 2 Year In House Warranty
- WELS 5 Star 5.5L/Minl
- PEX Flexible Tails

Code	R.R.P (inc GST)
VALPOSSIS	\$505



Valerno Pull Out Sink Mixer Coal

- Manufactured from 304 Stainless Steel
- Finish - Black with Nano Coating
- Lead Free Tap Body
- 35mm Cold Start Cartridge Position
- 2 Function Pattern Spray Head
- Flexible Ball Joint Spray Head – Stainless Steel
- Finish Warranty 5 Years
- Lifetime Warranty Construction of the Tap Body
- Cartridge – 15 Year Product Replacement Warranty
- Labour 2 Year In House Warranty
- WELS 5 Star 5.5L/Minl
- PEX Flexible Tails

Code	R.R.P (inc GST)
VALPOSSIS-BL	\$619

ACCESSORIES





Capri Robe Hook Chrome

- Polished Stainless Steel
- 2 screw fixing system
- 10 year product replacement only

Code	R.R.P (inc GST)
CARHC	\$28



Capri Toilet Roll Holder Chrome

- Polished Stainless Steel
- 2 screw fixing system
- 10 year product replacement only

Code	R.R.P (inc GST)
CATRHC	\$37



Capri Straight Toilet Roll Holder Chrome

- Polished Stainless Steel
- 2 screw fixing system
- 10 year product replacement only

Code	R.R.P (inc GST)
CATRHC2	\$39



Capri Round Towel Ring Chrome

- Polished Stainless Steel
- 2 screw fixing system
- 10 year product replacement only

Code	R.R.P (inc GST)
CATRC	\$38



Capri 250mm Guest Towel Rail Chrome

- Polished Stainless Steel
- 2 screw fixing system
- 10 year product replacement only

Code	R.R.P (inc GST)
CA250GTRC	\$52



Capri 850mm Single Towel Rail Chrome

- Rail length can be cut down to required size
- Polished Stainless Steel
- 2 screw fixing system
- 10 year product replacement only

Code	R.R.P (inc GST)
CASTRC	\$62



Capri 850mm Double Towel Rail Chrome

- Rail length can be cut down to required size
- Polished Stainless Steel
- 2 screw fixing system
- 10 year product replacement only

Code	R.R.P (inc GST)
CADTRC	\$90



Capri Metal Deluxe Soap Dish Chrome

- Slotted dish for water drainage
- Polished Stainless Steel
- 2 screw fixing system
- 10 year product replacement only

Code	R.R.P (inc GST)
CAMSDSC	\$52



Capri 450mm Shower Shelf Chrome

- Slotted dish for water drainage
- Polished Stainless Steel
- 2 screw fixing system
- 10 year product replacement only

Code	R.R.P (inc GST)
CAMS450C	\$121



Capri Glass Shelf Chrome

- Glass Shelf
- Polished Stainless Steel posts
- 2 screw fixing system
- 10 year product replacement only

Code	R.R.P (inc GST)
CAGSSC	\$94



Capri Robe Hook Black

- 2 screw fixing system
- Matte Black finish
- 10 year product replacement only
- 2 year warranty on Black finish

Code	R.R.P (inc GST)
CARHB	\$41



Capri Straight Toilet Roll Holder Black

- 2 screw fixing system
- Matte Black finish
- 10 year product replacement only
- 2 year warranty on Black finish

Code	R.R.P (inc GST)
CATRHB	\$55



Capri Towel Ring Black

- 2 screw fixing system
- Matte Black finish
- 10 year product replacement only
- 2 year warranty on Black finish

Code	R.R.P (inc GST)
CATRRB	\$73



Capri 850mm Single Towel Rail Black

- Rail length can be cut down to required size
- 2 screw fixing system
- Matte Black finish
- 10 year product replacement only
- 2 year warranty on Black finish

Code	R.R.P (inc GST)
CASTRB	\$90



Capri 850mm Double Towel Rail Black

- Rail length can be cut down to required size
- 2 screw fixing system
- Matte Black finish
- 10 year product replacement only
- 2 year warranty on Black finish

Code	R.R.P (inc GST)
CADTRB	\$115



Capri Metal Deluxe Soap Dish Black

- Slotted dish for water drainage
- 2 screw fixing system
- Matte Black finish
- 10 year product replacement only
- 2 year warranty on Black finish

Code	R.R.P (inc GST)
CAMDSDB	\$100



Capri 450mm Shower Shelf Black

- Solid Stainless Steel construction
- 10 year product replacement only
- 2 year warranty on Black finish

Code	R.R.P (inc GST)
CAMS450B	\$146



Capri Glass Shelf Black

- Solid Stainless Steel posts
- Matte black finish
- 10 year product replacement only
- 2 year warranty on BLACK finish

Code	R.R.P (inc GST)
CAGSSC-B	\$104



Capri Robe Hook Brushed Nickel

- 2 screw fixing system
- Brushed Nickel finish
- 10 year product replacement only

Code	R.R.P (inc GST)
CARH-NI	\$50



Capri Straight Toilet Roll Holder Brushed Nickel

- 2 screw fixing system
- Brushed Nickel finish
- 10 year product replacement only

Code	R.R.P (inc GST)
CATRHC2-NI	\$69



Capri 450mm Shower Shelf Brushed Nickel

- 2 screw fixing system
- Brushed Nickel finish
- 10 year product replacement only

Code	R.R.P (inc GST)
CAMS450-NI	\$156



Capri 850mm Single Towel Rail Brushed Nickel

- Rail length can be cut down to required size
- 2 screw fixing system
- Brushed Nickel finish
- 10 year product replacement only

Code	R.R.P (inc GST)
CASTR-NI	\$94



Capri 850mm Double Towel Rail Brushed Nickel

- Rail length can be cut down to required size
- 2 screw fixing system
- Brushed Nickel finish
- 10 year product replacement only

Code	R.R.P (inc GST)
CADTR-NI	\$136



Capri Robe Hook Gun Metal

- 2 screw fixing system
- Gun Metal finish
- 10 year product replacement only

Code	R.R.P (inc GST)
CARH-GM	\$55



Capri Straight Toilet Roll Holder Gun Metal

- 2 screw fixing system
- Gun Metal finish
- 10 year product replacement only

Code	R.R.P (inc GST)
CATRHC2-GM	\$76



Capri 450mm Shower Shelf Gun Metal

- 2 screw fixing system
- Gun Metal finish
- 10 year product replacement only

Code	R.R.P (inc GST)
CAMS450-GM	\$172



Capri 850mm Single Towel Rail Gun Metal

- Rail length can be cut down to required size
- 2 screw fixing system
- Gun Metal finish
- 10 year product replacement only

Code	R.R.P (inc GST)
CASTR-GM	\$104



Capri 850mm Double Towel Rail Gun Metal

- Rail length can be cut down to required size
- 2 screw fixing system
- Gun Metal finish
- 10 year product replacement only

Code	R.R.P (inc GST)
CADTR-GM	\$150



Elba Robe Hook Chrome

- Polished Stainless Steel finish
- 2 screw fixing system
- 10 year product replacement only

Code	R.R.P (inc GST)
ELRHC	\$37



Elba Toilet Roll Holder Chrome

- Polished Stainless Steel finish
- 2 screw fixing system
- 10 year product replacement only

Code	R.R.P (inc GST)
ELTRHC	\$45



Elba Towel Holder Chrome

- Polished Stainless Steel finish
- 2 screw fixing system
- 10 year product replacement only

Code	R.R.P (inc GST)
ELTHC	\$48



Elba 610mm & 810mm Single & Double Towel Rail Chrome

- Polished Stainless Steel finish
- 2 screw fixing system
- 10 year product replacement only

Code	R.R.P (inc GST)
EL600STR (610mm)	\$73
ELSTRC (810mm)	\$83
EL600DTRC (610mm)	\$94
ELDTRC (810mm)	\$115



Elba Glass Shelf Chrome

- Polished Stainless Steel finish
- 2 screw fixing system
- 10 year product replacement only

Code	R.R.P (inc GST)
ELGSC	\$111



Elba Robe Hook Black

- 2 screw fixing system
- Matte Black finish
- 10 year product replacement only
- 2 year warranty on Black finish

Code	R.R.P (inc GST)
ELRH-B	\$41



Elba Toilet Roll Holder Black

- 2 screw fixing system
- Matte Black finish
- 10 year product replacement only
- 2 year warranty on Black finish

Code	R.R.P (inc GST)
ELTRH-B	\$55



Elba Towel Holder Black

- 2 screw fixing system
- Matte Black finish
- 10 year product replacement only
- 2 year warranty on Black finish

Code	R.R.P (inc GST)
ELTH-B	\$62



Elba 610mm & 810mm Single & Double Towel Rail Black

- Matte Black finish
- 2 screw fixing system
- 10 year product replacement only
- 2 year warranty on Black finish



Code	R.R.P (inc GST)
EL600STR-B (610mm)	\$104
ELSTR-B (810mm)	\$115
EL600DTR-B (610mm)	\$121
ELDTR-B (810mm)	\$136



Elba Glass Shelf Black

- 2 screw fixing system
- Matte Black finish
- 10 year product replacement only
- 2 year warranty on Black finish

Code	R.R.P (inc GST)
ELGS-B	\$157



Uni-Pop Pop-up Waste Chrome/Black/Brushed Nickel

- Universal to suit with or without overflow basins
- Multifit 32mm top with 40mm base
- 7 year product replacement only
- 2 year warranty on black finish
- Chrome plated solid brass, Matte Black, Brushed Nickel or Gun Metal

Code	R.R.P (inc GST)
UNIPOP-CH	\$41
UNIPOP-BL	\$58
UNIPOP-NI	\$69
UNIPOP-GM	\$75



Pop Up Basket Pullout Waste Chrome

- Completely removable basket waste insert - Plumber code approved
- 7 year product replacement only
- Chrome plated solid brass
- 40mm only available Non-Overflow
- 40mm recommended for baths only

Code	R.R.P (inc GST)
POBAS32SWC (32mm non-overflow)	\$49
POBAS32OFC (32mm overflow)	\$59
POBBAS40C (bath only 40mm non-o'flow)	\$49



Pop Up Basket Pullout Waste Black

- Completely removable basket waste insert - Plumber code approved
- 7 year product replacement only
- 2 year warranty on black finish
- Matte black finish
- 40mm only available Non-Overflow
- 40mm recommended for baths only

Code	R.R.P (inc GST)
POBAS32SW-BL (32mm non-overflow)	\$75
POBAS32OF-BL (32mm overflow)	\$75
POBBAS40-BL (bath only 40mm non-o'flow)	\$75



Pop Up Basket Pullout Waste Brushed Nickel

- ALSO SUPPLIED WITH DOME CAP OPTION IN BOX
- 7 year product replacement only
- 2 year warranty on black finish
- Brushed Nickel finish
- 40mm only available Non-Overflow
- 40mm recommended for baths only

Code	R.R.P (inc GST)
POBBAS40-NI (bath only 40mm non-o'flow)	\$85



Milan Bottle Trap

- Brass construction
- Comes with 32mm to 40mm adapter
- Supplied with thick 30mm wall cover plate
- 2 year warranty on colour finish
- 10 year product replacement only

Code	R.R.P (inc GST)
MILBT	\$115
MILBT-B	\$169
MILBT-NI	\$195



Ceramic Cap with Pop Up Basket Pullout Waste Chrome

- 32mm Non-Overflow Waste
- ALSO SUPPLIED WITH DOME CAP OPTION IN BOX
- Completely removable basket waste insert
- Plumber code approved
- 7 year product replacement only
- Chrome plated solid brass

Code	R.R.P (inc GST)
POBAS32SW-GW (Gloss white)	\$75
POBAS32SW-MW (Matte White)	\$75
POBAS32SW-MP (Matte Pink)	\$75
POBAS32SW-MG (Matte Grey)	\$75
POBAS32SW-BLMB (Matte Black)	\$85

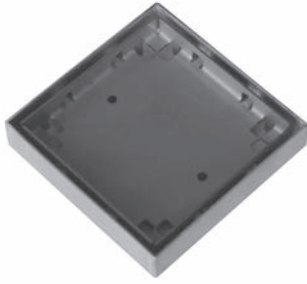

100mm Tile Insert Floor Grate

- Lifetime warranty
 - 10 year warranty on colour finish
 - Available as 76mm pr 90mm outlet
 - Australian Made 304 Grade
- 100L x 100W x 22D
Available Heal Guard or as Tile Insert

Code	R.R.P (inc GST)
FG100TI-76	\$85
FG100TI-90	\$85
FG100TI-B76	\$185
FG100TI-B90	\$185

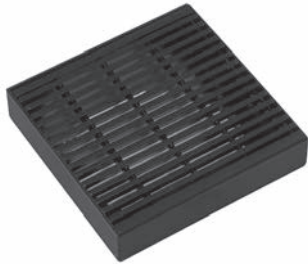

100mm Heel Guard Floor Grate

- Lifetime warranty
 - 10 year warranty on colour finish
 - Available as 76mm pr 90mm outlet
 - Australian Made 304 Grade
 - Matte Black finish
- 100L x 100W x 22D
Available Heal Guard or as Tile Insert

Code	R.R.P (inc GST)
FG100HM-76	\$119
FG100HM-90	\$119
FG100HM-B76	\$195
FG100HM-B90	\$195



Edge Tile Insert Strip Grate

- Adjustable outlet and cutting tool included
- 45mm outlet
- Other sizes and applications POA
- Lifetime warranty
- Australian Made 304 Grade

800L x 85W x 30D
Other sizes available P.O.A

Code	R.R.P (inc GST)
SG800SSTIED	\$649



Edge Heelguard Mesh Strip Grate

- Adjustable outlet and cutting tool included
- 45mm outlet
- Other sizes and applications POA
- Lifetime warranty
- Australian Made 304 Grade

800L x 85W x 30D
Other sizes available P.O.A

Code	R.R.P (inc GST)
SG800SSHMED	\$649



Tile Insert Strip Grate

- Adjustable outlet and cutting tool included
- 45mm outlet
- Other sizes and applications POA
- Lifetime warranty
- Australian Made 304 Grade

800L x 85W x 30D
Other sizes available P.O.A

Code	R.R.P (inc GST)
SG800SSTI	\$649



Heelguard Mesh Strip Grate

- Adjustable outlet and cutting tool included
- 45mm outlet
- Other sizes and applications POA
- Lifetime warranty
- Australian Made 304 Grade

800L x 85W x 30D
Other sizes available P.O.A

Code	R.R.P (inc GST)
SG800SSHM	\$649



Tile Insert Strip Grate Black

- Measurement for welded outlet must be provided when ordering
- 45mm outlet
- 10 year warranty on colour finish
- Other sizes and applications POA
- Lifetime warranty
- Australian Made 304 Grade

800L x 85W x 30D
Other sizes available P.O.A

Code	R.R.P (inc GST)
SG800SSTI-B	\$899



Heelguard Mesh Strip Grate Black

- Measurement for welded outlet must be provided when ordering
- 45mm outlet
- 10 year warranty on colour finish
- Other sizes and applications POA
- Lifetime warranty
- Australian Made 304 Grade

800L x 85W x 30D
Other sizes available P.O.A

Code	R.R.P (inc GST)
SG800SSHM-B	\$899



VANITIES

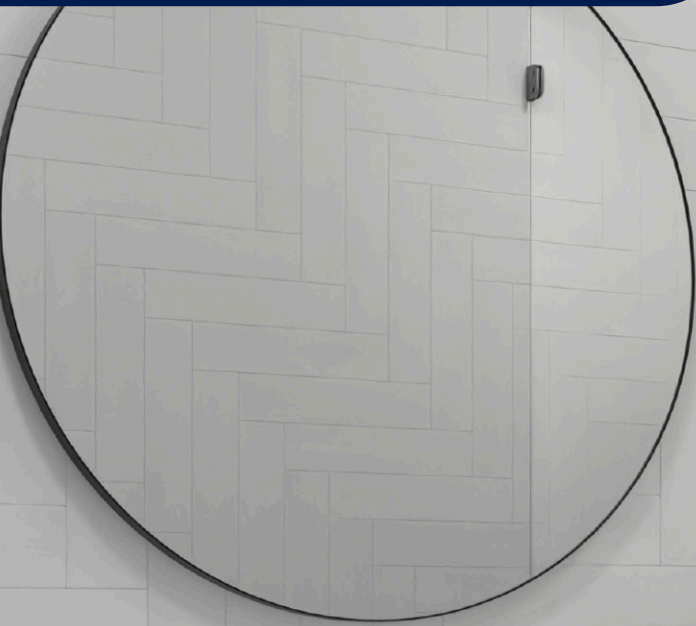

Tirami



Tirami 600mm on Kicker White shown (TIR600KRWH)
Milan Shower on Rail Chrome (MISORC)
Milan Basin Mixer Chrome (MIBAC)

Includes 50mm Polymarble top (1TH)
Elegant Finger Pull Door
Soft close door
5 Year product replacement only
1 Year labour
Available in Gloss White and Oak Timbertone
32mm Non-overflow waste required



Tirami 400 Ensuite Vanity Finger Pull on Kicker

- Includes 50mm Polymarble top (1TH)
 - Reversible door
 - 1 door
 - 5 year warranty
 - 32mm non-overflow waste required
- 400w x 220d x 870h
 - Available in Gloss White & Oak Timbertone

Product	RRP (inc GST)	Code
Tirami 400 Ensuite Vanity Finger Pull On Kicker Gloss White - Reversible Door	\$482	TIR400KRWH
Tirami 400 Ensuite Vanity Finger Pull On Kicker Oak - Reversible Door	\$482	TIR400KROAK



Tirami 400 Ensuite Vanity Finger Pull Wall Hung

- Includes 50mm Polymarble top (1TH)
 - Reversible door
 - 1 door
 - 5 year warranty
 - 32mm non-overflow waste required
- 400w x 220d x 570h
 - Available in Gloss White & Oak Timbertone

Product	RRP (inc GST)	Code
Tirami 400 Ensuite Vanity Finger Pull WALL HUNG Gloss White - Reversible Door	\$482	TIR400WHWH
Tirami 400 Ensuite Vanity Finger Pull WALL HUNG Oak - Reversible Door	\$482	TIR400WHOAK



Tirami 600 Ensuite Vanity Finger Pull on Kicker

- Includes 50mm Polymarble top (1TH)
 - Soft close doors
 - 2 door
 - 5 year warranty
 - 32mm non-overflow waste required
- 600w x 320d x 890h
 - Available in Gloss White & Oak Timbertone

Product	RRP (inc GST)	Code
Tirami 600 Ensuite Vanity Finger Pull On Kicker Gloss White	\$579	TIR600KRWH
Tirami 600 Ensuite Vanity Finger Pull On Kicker Oak	\$579	TIR600KROAK



Tirami 600 Ensuite Vanity Finger Pull Wall Hung

- Includes 50mm Polymarble top (1TH)
 - Soft close doors
 - 2 door
 - 5 year warranty
 - 32mm non-overflow waste required
- 600w x 320d x 570h
 - Available in Gloss White & Oak Timbertone

Product	RRP (inc GST)	Code
Tirami 600 Ensuite Vanity Finger Pull WALL HUNG White	\$579	TIR600WHWH
Tirami 600 Ensuite Vanity Finger Pull WALL HUNG Oak	\$579	TIR600WHOAK

TOP ONLY

Tirami 400mm x 220mm Ensuite Poly Marble Top	VEREN400TOP	\$205
Tirami 600mm x 320mm Ensuite Poly Marble Top	VEREN600TOP	\$259

SEE WASTES UPGRADE OPTIONS

Vienna Satin White



1200mm Vienna Satin White Vanity with Valencia Gloss White Top Shown (VIE1200SWVAL)
Milan Basin Mixer Chrome Shown (MIBAC)

Satin white cabinet
Chrome/Ceramic knob
Soft close doors & drawers
Drawers available L/H or R/H
5 Year product replacement only
1 Year labour
See corresponding top for waste required
3 Tap Hole Available

TOP OPTIONS



VALENCIA



GENOA TOP



UNIVERSAL



SOLID SURFACE BENCHTOP
WITH BASIN



750 Vienna Kickboard Vanity 750w x 460d x 850h

Product	RRP (inc GST)	Code
750 Vienna RH Drawers Satin White with Genoa Gloss White Ceramic Top	\$899	VIE750SWGEM
750 Vienna RH Drawers Satin White with Valencia Gloss White Ceramic Top	\$899	VIE750SWVAL
750 Vienna RH Drawers Satin White with Solid Surface Universal Top	\$1255	VIE750SWUNI
750 Vienna LH Drawers Satin White with Genoa Gloss White Ceramic Top	\$899	VIE750SWLHGEN
750 Vienna LH Drawers Satin White with Valencia Gloss White Ceramic Top	\$899	VIE750SWLHVAL
750 Vienna LH Drawers Satin White with Solid Surface Universal Top	\$1255	VIE750SWLHUNI
750 Vienna *CAB ONLY* RH Drawers Satin White	\$715	VIE750SWRH
750 Vienna *CAB ONLY* LH Drawers Satin White	\$715	VIE750SWLH



900 Vienna Kickboard Vanity 900w x 460d x 850h

Product	RRP (inc GST)	Code
900 Vienna RH Drawers Satin White with Genoa Gloss White Ceramic Top	\$975	VIE900SWGEM
900 Vienna RH Drawers Satin White with Genoa Matte White Ceramic Top	\$1079	VIE900SWGEMMW
900 Vienna RH Drawers Satin White with Valencia Gloss White Ceramic Top	\$975	VIE900SWVAL
900 Vienna RH Drawers Satin White with Solid Surface Universal Top	\$1349	VIE900SWUNI
900 Vienna LH Drawers Satin White - Genoa Gloss White Ceramic Top	\$975	VIE900SWLHGEN
900 Vienna LH Drawers Satin White with Genoa Matte White Ceramic Top	\$1079	VIE900SWLHGENMW
900 Vienna LH Drawers Satin White with Valencia Gloss White Ceramic Top	\$975	VIE900SWLHVAL
900 Vienna LH Drawers Satin White With Solid Surface Universal Top	\$1349	VIE900SWLHUNI
900 Vienna *CAB ONLY* RH Drawers Satin White	\$809	VIE900SWRH
900 Vienna *CAB ONLY* LH Drawers Satin White	\$809	VIE900SWLH



1200 Vienna Kickboard Vanity 1200w x 460d x 850h

Product	RRP (inc GST)	Code
1200 Vienna RH Drawers Satin White with Genoa Gloss White Ceramic Top	\$1345	VIE1200SWGEM
1200 Vienna RH Drawers Satin White with Genoa Matte White Ceramic Top	\$1505	VIE1200SWMMWG
1200 Vienna RH Drawers Satin White with Valencia Gloss White Ceramic Top	\$1345	VIE1200SWVAL
1200 Vienna RH Drawers Satin White With Solid Surface Universal Top	\$1685	VIE1200SWUNI
1200 Vienna LH Drawers Satin White with Genoa Gloss White Ceramic Top	\$1345	VIE1200SWLHGEN
1200 Vienna LH Drawers Satin White with Genoa Matte White Ceramic Top	\$1505	VIE1200SWLHMMWG
1200 Vienna LH Drawers Satin White with Valencia Gloss White Ceramic Top	\$1345	VIE1200SWLHVAL
1200 Vienna LH Drawers Satin White with Solid Surface Universal Top	\$1685	VIE1200SWLHUNI
1200 Vienna *CAB ONLY* RH Drawers Satin White	\$965	VIE1200SWRH CAB
1200 Vienna *CAB ONLY* LH Drawers Satin White	\$965	VIE1200SWLH CAB



1500 Vienna Double Bowl Kickboard Vanity 1500w x 460d x 850h

Product	RRP (inc GST)	Code
1500 Vienna Centred Drawers Satin White Genoa Double Bowl Ceramic Top	\$2365	VIE1500SWGEM
1500 Vienna Centred Drawers Satin White Valencia Double Bowl Ceramic Top	\$2365	VIE1500SWVAL
1500 Vienna Centred Drawers Satin White Solid Surface Double Bowl Universal Top	\$2365	VIE1500SWUNI
1500 Vienna Centred Drawers Satin White *CAB ONLY* Suits Double Bowl Top	\$1489	VIE1500SWCAB

DRILLCHARGE (3 TH) \$50

SEE PAGE 121 FOR KNOB/T BAR - SOLID SURFACE OPTIONS PAGE 134 - STONE BENCHTOP OPTIONS PAGE 135

Vienna Wall Hung Satin White



900mm Vienna Wall Hung RH Draws Satin White with Valencia Gloss
White Top (VIE900SWWHVAL)
Siera Basin Mixer Black Shown (SIBA-B)
Milan Shower on Rail Black Shown (MISOR-B)

Soft close fingerpull drawers
Available in Satin White Left or Right hand draws
5 Year product replacement only
1 Year labour
See corresponding top for waste required
3 Tap Hole Available

TOP OPTIONS



VALENCIA



GENOA TOP



UNIVERSAL



SOLID SURFACE BENCHTOP
WITH BASIN



900 Vienna Wall Hung Vanity Satin White 900 x 460 x 520

Product	RRP (inc GST)	Code
900 Vienna Wall Hung RH Drawers Satin White Valencia VC Gloss White Top	\$945	VIE900SWWHVAL
900 Vienna Wall Hung LH Drawers Satin White Valencia VC Gloss White Top	\$945	VIE900SWWHLHVAL
900 Vienna Wall Hung RH Drawers Satin White Genoa Matte White VC Top	\$1086	VIE900SWWHMWG
900 Vienna Wall Hung LH Drawers Satin White Genoa Matte White VC Top	\$1086	VIE900SWWHLHMWG
900 Vienna Wall Hung RH Drawers Satin White Solid Surface Universal Top	\$1317	VIE900SWWHUNI
900 Vienna Wall Hung LH Drawers Satin White Solid Surface Universal Top	\$1317	VIE900SWWHLHUNI
900 Vienna Wall Hung RH Drawers Satin White *CAB ONLY*	\$739	VIE900SWWHCAB
900 Vienna Wall Hung LH Drawers Satin White *CAB ONLY*	\$739	VIE900SWWHLHCAB



1200 Vienna Wall Hung Vanity Satin White 1200 x 460 x 520

Product	RRP (inc GST)	Code
1200 Vienna Wall Hung RH Drawers Satin White Valencia VC Gloss White Top	\$1259	VIE1200SWWAL
1200 Vienna Wall Hung RH Drawers Satin White Genoa Matt White VC Top	\$1419	VIE1200SWWHMWG
1200 Vienna Wall Hung LH Drawers Satin White Valencia VC Gloss White Top	\$1259	VIE1200SWLHVAL
1200 Vienna Wall Hung LH Drawers Satin White Genoa Matt White VC Top	\$1419	VIE1200SWWHLHMWG
1200 Vienna Wall Hung RH Drawers Satin White Solid Surface Universal Top	\$1599	VIE1200SWWHUNI
1200 Vienna Wall Hung LH Drawers Satin White Solid Surface Universal Top	\$1599	VIE1200SWWHLHUNI
1200 Vienna Wall Hung RH Drawers Satin White *CAB ONLY*	\$949	VIE1200SWWHCAB
1200 Vienna Wall Hung LH Drawers Satin White *CAB ONLY*	\$949	VIE1200SWWHLHCAB



Vanity Knobs

Code		R.R.P (inc GST)
VIEHDL	Chrome knob for Vienna	\$14
VIEHDL-B	Black knob for Vienna	\$20
	T-Bar Brushed Brass	\$20
	T-Bar Brushed Nickel	\$20

SEE TOP OPTIONS

DRILLCHARGE (3 TH) \$50

Catani Wall Hung Satin White



1200mm Catani Satin White Vanity with Valencia Gloss White Top Shown
(CAT1200SWWHVAL)

Fingerpull soft close doors & drawers
Available in Satin White
5 Year product replacement only
1 Year labour
See corresponding top for waste required
3 Tap Hole Available

TOP OPTIONS



VALENCIA



GENOA TOP



UNIVERSAL



SOLID SURFACE BENCHTOP
WITH BASIN

CATANI 900 WALL HUNG SATIN WHITE		
Product	RRP (inc GST)	Code
900 Catani Wall Hung RH Drawers Satin White With Valencia VC Gloss White Top	\$1155	CAT900SWWHVAL
900 Catani Wall Hung RH Drawers Satin White With Genoa Matt White VC Top	\$1296	CAT900SWWHGENMW
900 Catani Wall Hung RH Drawers Satin White With Solid Surface Universal Top	\$1299	CAT900SWWHUNI
900 Catani Wall Hung RH Drawers Satin White 12mm Solid Surface Top & Gloss Above Counter Basin	\$1499	CAT900SWWHSSGB
900 Catani Wall Hung RH Drawers Satin White 12mm Solid Surface Top & Matte VC Above Counter Basin	\$1649	CAT900SWWHSSMB
900 Catani Wall Hung RH Drawers Satin White 20mm Stone Top & Gloss Above Counter Basin	\$1699	CAT900SWWHSTGB
900 Catani Wall Hung RH Drawers Satin White 20mm Stone Top & Matte VC Above Counter Basin	\$1849	CAT900SWWHSTMB
900 Catani Wall Hung RH Drawers Satin White *CAB ONLY*	\$849	CAT900SWWHCAB

CATANI 1200 WALL HUNG SATIN WHITE		
Product	RRP (inc GST)	Code
1200 Catani Wall Hung RH Drawers Satin White With Valencia VC Gloss White Top	\$1469	CAT1200SWWHVAL
1200 Catani Wall Hung RH Drawers Satin White With Genoa Matt White VC Top	\$1629	CAT1200SWWHGENMW
1200 Catani Wall Hung RH Drawers Satin White Solid Surface Universal Top	\$1810	CAT1200SWWHUNI
1200 Catani Wall Hung RH Drawers Satin White 12mm Solid Surface Top & Gloss Above Counter Basin	\$1899	CAT1200SWWHSSGB
1200 Catani Wall Hung RH Drawers Satin White 12mm Solid Surface Top & Matte VC Above Counter Basin	\$2049	CAT1200SWWHSSMB
1200 Catani Wall Hung RH Drawers Satin White 20mm Stone Top & Gloss Above Counter Basin	\$1999	CAT1200SWWHSTGB
1200 Catani Wall Hung RH Drawers Satin White 20mm Stone Top & Matte VC Above Counter Basin	\$2149	CAT1200SWWHSTMB
1200 Catani Wall Hung RH Drawers Satin White *CAB ONLY*	\$1069	CAT1200SWWHCAB

CATANI 1500 WALL HUNG SATIN WHITE		
Product	RRP (inc GST)	Code
1500 Catani Wall Hung Centre Drawers Satin White With Valencia VC Double Bowl Gloss White Top	\$2599	CAT1500SWWHVAL
1500 Catani Wall Hung Centre Drawers Satin White With Solid Surface Double Bowl Universal Top	\$2599	CAT1500SWWHUNI
1500 Catani Wall Hung RH Drawers Satin White With 12mm Solid Surface Top and Dual Gloss Above Counter Basins	\$2599	CAT1500SWWHSSGB
1500 Catani Wall Hung RH Drawers Satin White With 12mm Solid Surface Top & Dual Matte VC Above Counter Basins	\$2899	CAT1500SWWHSSGB
1500 Catani Wall Hung Centre Drawers Satin White *CAB ONLY*	\$1429	CAT1500SWWHCAB

DRILLCHARGE (3 TH) \$50

SEE PAGE 134 FOR SOLID SURFACE BENCHTOP OPTIONS

Janine Full Depth 460mm Deep



Janine 1200mm OAK Full Depth (JANFD1200GWSSMB)
12mm Slate Solid Surface Bench Top
Sirea Flute Matte White Basin

Fingerpull soft close doors & drawers
Available in Gloss White & Oak Timbertone
5 Year product replacement only
1 Year labour
See corresponding top for waste required
3 Tap Hole Available

TOP OPTIONS



VALENCIA



GENOA



UNIVERSAL



SOLID SURFACE BENCHTOP
WITH BASIN



Janine White 600w x 460d Full Depth Vanity

Product	RRP (inc GST)	Code
600 x 460 Janine White with Genoa Gloss White Ceramic Top	\$649	JANFD600GWGEN
600 x 460 Janine White with Valencia Gloss White Ceramic Top	\$649	JANFD600GWVAL
600 x 460 Janine White 12mm Solid Surface Top Selected Gloss Basin	\$890	JANFD600GWSSGB
600 x 460 Janine White 12mm Solid Surface Top Selected Matt Basin	\$990	JANFD600GWSSMB
600 x 460 Janine White 12mm Solid Surface Top Selected Solid Surface Basin	\$1090	JANFD600GWSSSS
600 x 460 Janine White Vanity *CAB ONLY*	\$479	JANFD600WH



Janine White 750w x 460d Full Depth Vanity

Product	RRP (inc GST)	Code
750 x 460 Janine White with Genoa Gloss White Ceramic Top	\$749	JANFD750GWGEN
750 x 460 Janine White with Valencia Gloss White Ceramic Top	\$749	JANFD750GWVAL
750 X 460 Janine White with Solid Surface Universal Top	\$1190	JANFD750GWUNI
750 x 460 Janine White 12mm Solid Surface Top Selected Gloss Basin	\$1219	JANFD750GWSSGB
750 x 460 Janine White 12mm Solid Surface Top Selected Matt Basin	\$1399	JANFD750GWSSMB
750 x 460 Janine White 12mm Solid Surface Top Selected Solid Surface Basin	\$1499	JANFD750GWSSSS
750 x 460 Janine White Vanity *CAB ONLY*	\$599	JANFD750WH



Janine White 900w x 460d Full Depth Vanity

Product	RRP (inc GST)	Code
900 x 460 Janine White with Genoa Gloss White Ceramic Top	\$869	JANFD900GWGEN
900 x 460 Janine White with Valencia Gloss White Ceramic Top	\$869	JANFD900GWVAL
900 X 460 Janine White with Solid Surface Universal Top	\$1349	JANFD900GWUNI
900 x 460 Janine White 12mm Solid Surface Top Selected Gloss Basin	\$1349	JANFD900GWSSGB
900 x 460 Janine White 12mm Solid Surface Top Selected Matt Basin	\$1449	JANFD900GWSSMB
900 x 460 Janine White 12mm Solid Surface Top Selected Solid Surface Basin	\$1549	JANFD900GWSSSS
900 x 460 Janine White Vanity *CAB ONLY*	\$629	JANFD900WH



Janine White 1200w x 460d Full Depth Vanity

Product	RRP (inc GST)	Code
1200 x 460 Janine White with Genoa Gloss White Ceramic Top	\$1149	JANFD120GWGEN
1200 x 460 Janine White with Valencia Gloss White Ceramic Top	\$1149	JANFD120GWVAL
1200 X 460 Janine White with Solid Surface Universal Top	\$1449	JANFD120GWUNI
1200 x 460 Janine White 12mm Solid Surface Top Selected Gloss Basin	\$1449	JANFD120GWSSGB
1200 x 460 Janine White 12mm Solid Surface Top Selected Matt Basin	\$1549	JANFD120GWSSMB
1200 x 460 Janine White 12mm Solid Surface Top Selected Solid Surface Basin	\$1649	JANFD1200GWSSSS
1200 x 460 Janine White Vanity *CAB ONLY*	\$799	JANFD900WH



Janine Oak 900w x 460d Full Depth Vanity

Product	RRP (inc GST)	Code
900 x 460 Janine OAK with Genoa Gloss White Ceramic Top	\$869	JANFD900OAKGEN
900 x 460 Janine OAK with Valencia Gloss White Ceramic Top	\$869	JANFD900OAKVAL
900 X 460 Janine OAK with Solid Surface Universal Top	\$1349	JANFD900OAKUNI
900 x 460 Janine OAK 12mm Solid Surface Top Selected Gloss Basin	\$1349	JANFD900OAKSSGB
900 x 460 Janine OAK 12mm Solid Surface Top Selected Matt Basin	\$1449	JANFD900OAKSSMB
900 x 460 Janine OAK 12mm Solid Surface Top Selected Solid Surface Basin	\$1549	JANFD900OAKSSSS
900 x 460 Janine OAK Vanity *CAB ONLY*	\$629	JANFD900OAK



Janine Oak 1200w x 460d Full Depth Vanity

Product	RRP (inc GST)	Code
1200 x 460 Janine OAK with Genoa Gloss White Ceramic Top	\$1149	JANFD1200OAKGEN
1200 x 460 Janine OAK with Valencia Gloss White Ceramic Top	\$1149	JANFD1200OAKVAL
1200 X 460 Janine OAK with Solid Surface Universal Top	\$1449	JANFD1200OAKUNI
1200 x 460 Janine OAK 12mm Solid Surface Top Selected Gloss Basin	\$1449	JANFD1200OAKSSGB
1200 x 460 Janine OAK 12mm Solid Surface Top Selected Matt Basin	\$1549	JANFD1200OAKSSMB
1200 x 460 Janine OAK 12mm Solid Surface Top Selected Solid Surface Basin	\$1649	JANFD1200OAKSSSS
1200 x 460 OAK White Vanity *CAB ONLY*	\$799	JANFD1200OAK

Janine Ensuite 360mm Deep



Janine 900mm Ensuite White Gloss
with Vitreous China top (JANEN900GWVCT)
Elba Basin Mixer Chrome Shown (ELBAC2)
Universal Chrome Popup Shown (UNIPOP-CH)
Lucca S-Trap Toilet Shown (LUCCSW)

Fingerpull soft close doors & drawers
Available in Gloss White & Oak Timbertone
5 Year product replacement only
1 Year labour
See corresponding top for waste required
3 Tap Hole Available

TOP OPTIONS



JANINE EN-SUITE



SOLID SURFACE BENCHTOP
WITH BASIN



750 Janine Ensuite Vanity 750w x 360d x 850h

Product	RRP (inc GST)	Code
750 x 360 Janine White with Janine Ceramic Top	\$735	JANEN750GWJAN
750 x 360 Janine OAK with Janine Ceramic Top	\$735	JANEN750OAKJAN
750 x 360 Janine White 12mm Solid Surface Top & Mini Siera/Roma Gloss Basin	\$1190	JANEN750GWSSMGB
750 x 360 Janine OAK 12mm Solid Surface Top & Mini Siera/Roma Gloss Basin	\$1190	JANEN750OAKSSMGB
750 x 360 Janine White 12mm Solid Surface Top & Mini Siera/Roma Matte Basin	\$1340	JANEN750GWSSMMB
750 x 360 Janine OAK 12mm Solid Surface Top & Mini Siera/Roma Matte Basin	\$1340	JANEN750OAKSSMMB
750 x 360 Janine White Ensuite Vanity *CAB ONLY*	\$585	JANEN750WH
750 x 360 Janine OAK Ensuite Vanity *CAB ONLY*	\$585	JANEN750OAK



900 Janine Ensuite Vanity 900w x 360d x 850h

Product	RRP (inc GST)	Code
900 x 360 Janine White with Janine Ceramic Top	\$835	JANEN900GWJAN
900 x 360 Janine OAK with Janine Ceramic Top	\$835	JANEN900OAKJAN
900 x 360 Janine White 12mm Solid Surface Top & Mini Siera/Roma Gloss Basin	\$1290	JANEN900GWSSMGB
900 x 360 Janine OAK 12mm Solid Surface Top & Mini Siera/Roma Gloss Basin	\$1290	JANEN900OAKSSMGB
900 x 360 Janine White 12mm Solid Surface Top & Mini Siera/Roma Matte Basin	\$1440	JANEN900GWSSMMB
900 x 360 Janine OAK 12mm Solid Surface Top & Mini Siera/Roma Matte Basin	\$1440	JANEN900OAKSSMMB
900 x 360 Janine White Ensuite Vanity *CAB ONLY*	\$625	JANEN900WH
900 x 360 Janine OAK Ensuite Vanity *CAB ONLY*	\$625	JANEN900OAK

TOP ONLY

Janine 750mm x 360mm Ensuite Vitreous China Top	JANEN750GW	\$295
Janine 900mm x 360mm Ensuite Vitreous China Top	JANEN900GW	\$335



Janine 750mm Ensuite White Gloss with Greco 12mm Solid Surface top with Mini Siera Gloss Basin (JANEN750GWSSMGB)

DRILLCHARGE (3 TH) \$50

SEE PAGE 134 FOR SOLID SURFACE BENCHTOP OPTIONS

Maali

DELETED

900mm Maali Gloss White Vanity Right Hand Draws with Valencia
Gloss White Ceramic Top Shown (MAA900GWRHVAL)

Fingerpull soft close doors & drawers
Available in Gloss White & Oak Timbertone
5 Year product replacement only
1 Year labour
See corresponding top for waste required
3 Tap Hole Available

TOP OPTIONS



VALENCIA



UNIVERSAL



SOLID SURFACE BENCHTOP
WITH BASIN



600 Maali Full Depth Vanity 600w x 460d x 850h

Product	RRP (inc GST)	Code
Maali 600 Vanity With Valencia VC Top White	\$609	MAA600GWVAL
Maali 600 Vanity Cabinet Only	\$369	MAA600GWCAB



750 Maali Full Depth Vanity 750w x 460d x 850h

Product	RRP (inc GST)	Code
Maali 750 RH Drawers Vanity White With Valencia VC Top White	\$734	MAA750GWRHVAL
Maali 750 RH Drawers Vanity White With Solid Surface Universal Top	\$1085	MAA750GWRHUNI
Maali 750 LH Drawers Vanity White With Valencia VC Top White	\$734	MAA750GWLHVAL
Maali 750 LH Drawers Vanity White With Solid Surface Universal Top	\$1085	MAA750GWLHUNI
Maali 750 Vanity RH Drawers Cabinet Only	\$469	MAA750GWCAB
Maali 750 Vanity LH Drawers Cabinet Only	\$469	MAA750GWCABLH



900 Maali Full Depth Vanity 900w x 460d x 850h

Product	RRP (inc GST)	Code
Maali 900 RH Drawers Vanity White With Valencia VC Top White	\$839	MAA900GWRHVAL
Maali 900 RH Drawers Vanity White With Solid Surface Universal Top	\$1215	MAA900GWRHUNI
Maali 900 RH Drawers Vanity OAK With Valencia VC Top White	\$839	MAA900OAKRHVAL
Maali 900 RH Drawers Vanity OAK With Solid Surface Universal Top	\$1215	MAA900OAKRHUNI
Maali 900 LH Drawers Vanity White With Valencia VC Top White	\$839	MAA900GWLHVAL
Maali 900 LH Drawers Vanity White With Solid Surface Universal Top	\$1215	MAA900GWLHUNI
Maali 900 RH Drawers Cabinet Only White	\$529	MAA900GWCAB
Maali 900 LH Drawers Cabinet Only White	\$529	MAA900GWCABLH
Maali 900 RH Drawers OAK Cabinet Only	\$529	MAA900OAKCAB



1200 Maali Full Depth Vanity 1200w x 460d x 850h

Product	RRP (inc GST)	Code
Maali 1200 Vanity White With Double Drawer Centre Doors With Valencia VC Top White	\$1154	MAA1200DDGWVAL
Maali 1200 Vanity White With Double Drawer, Centre Doors With Solid Surface Universal Top	\$1496	MAA1200DDGWUNI
Maali 1200 Vanity OAK With Double Drawer, Centre Doors With Valencia VC Top White	\$1154	MAA1200DDOAKVAL
Maali 1200 Vanity OAK With Double Drawers, Centre Doors With Solid Surface Universal Top	\$1496	MAA1200DDOAKUNI
Maali 1200 Vanity White RH Drawers With Valencia VC Top White	\$1154	MAA1200WHVAL
Maali 1200 vanity White RH Drawers With Solid Surface Universal Top	\$1496	MAA1200WHUNI
Maali 1200 Vanity White With Double Drawer, Centre Doors *CAB ONLY*	\$729	MAA1200DDGWCAB
Maali 1200 Vanity OAK With Double Drawer, Centre Doors *CAB ONLY*	\$729	MAA1200DDOAKCAB



1500 Maali Full Depth Vanity 1500w x 460d x 850h

Product	RRP (inc GST)	Code
Maali 1500 Vanity White Centre Drawers With Valencia VC Double Bowl Top White	\$1999	MAA1500CDGWVAL
Maali 1500 Vanity OAK Centre Drawers With Valencia VC Double Bowl Top White	\$1999	MAA1500CDOAKVAL
Maali 1500 Vanity White Centre Drawers With Universal Solid Surface Double Bowl Top	\$2339	MAA1500CDGWUNI
Maali 1500 Vanity OAK Centre Drawers With Universal Solid Surface Double Bowl Top	\$2339	MAA1500CDOAKUNI
Maali 1500 Vanity White Centre Drawers *CAB ONLY*	\$1225	MAA1500CDGWCAB
Maali 1500 Vanity OAK Centre Drawers *CAB ONLY*	\$1225	MAA1500CDOAKCAB

DRILLCHARGE (3 TH) \$50

SEE PAGE 134 SOLID SURFACE BENCHTOP OPTIONS

FLORENCE CABINETS



Florence 600mm Wall Cabinet Oak shown

- Pencil edge finish glass doors
- Quick release hinge
- Soft close doors
- Adjustable glass shelves
- 5 Year product replacement only
- 1 Year labour
- Available in Gloss White & Oak Timbertone



600 Florence Mirror Door Wall Cabinet

- Pencil edge finish glass doors
 - 2 Soft close doors
 - Adjustable glass shelves
 - 750mm high
 - 5 year product replacement only
- Available in Gloss White & Oak Timbertone

Code	R.R.P (inc GST)
600MSCWH	\$419
600MSCOAK	\$419



750 Florence Mirror Wall Cabinet

- Pencil edge finish glass doors
 - 2 Soft close doors
 - Adjustable glass shelves
 - 750mm high
 - 5 year product replacement only
- Available in Gloss White & Oak Timbertone

Code	R.R.P (inc GST)
750MSCWH	\$524
750MSCOAK	\$524



900 Florence Mirror Wall Cabinet

- Pencil edge finish glass doors
 - 2 Soft close doors
 - Adjustable glass shelves
 - 750mm high
 - 5 year product replacement only
- Available in Gloss White & Oak Timbertone

Code	R.R.P (inc GST)
900MSCWH	\$553
900MSCOAK	\$553



1200 Florence Mirror Wall Cabinet

- Pencil edge finish glass doors
 - 2 Soft close doors
 - Adjustable glass shelves
 - 750mm high
 - 5 year product replacement only
- Available in Gloss White & Oak Timbertone

Code	R.R.P (inc GST)
1200MSCWH	\$715
1200MSCOAK	\$715



Oak finish OR gloss white finish also used inside cabinet



Genoa

- Vitreous china integral bowl top (1 TH)
- 3 Tap hole available - DRILL CHARGE \$50
- Easy to clean (warm soapy water)
- 5 year product replacement only
- Requires 32mm overflow waste

600 x 460 Genoa Vitreous China Top Only	GEN600TOP	\$285
750 x 460 Genoa Vitreous China Top Only	GEN750TOP	\$305
900 x 460 Genoa Vitreous China Top Only	GEN900TOP (Gloss White)	\$340
900 x 460 Genoa Vitreous China Top Only - Matt White	GEN900TOP-MW (Matte White)	\$485
1200 x 460 Genoa Single Bowl Vitreous China Top Only	GEN1200TOP (Gloss White)	\$455
1200 x 460 Genoa Single Bowl Vitreous China Top Only - Matte White	GEN1200TOP-MW (Matte White)	\$615
1500 x 460 Genoa Double Bowl Vitreous China Top Only	GEN1500DTOP	\$1315



Valencia

- Vitreous china integral bowl top (1 TH)
- 3 Tap hole available - DRILL CHARGE \$50
- Easy to clean (warm soapy water)
- 5 year warranty
- Requires 32mm overflow waste

600 x 460 Valencia Vitreous China Top Only	VAL60TOP	\$285
750 x 460 Valencia Vitreous China Top Only	VAL75TOP	\$305
900 x 460 Valencia Vitreous China Top Only	VAL90TOP	\$340
1200 x 460 Valencia Single Bowl Vitreous China Top Only	VAL120TOP	\$455
1500 x 460 Valencia Double Bowl Vitreous China Top Only	VAL150DTOP	\$1315



750 Universal Solid Surface Bowl Top

- Non Porous
- Easy to clean (warm soapy water)
- Same colour all the way through sheet
- Scratches can be sanded out (wet & dry)
- Cuts and sands to desired lengths

Available in Pebble, Snow, Concrete or White

Code	R.R.P (inc GST)	
	Tap Hole	No Tap Hole
UNI7546C1TH	UNI7546C	\$656
UNI7546P1TH	UNI7546P	\$656
UNI7546S1TH	UNI7546S	\$656
UNI7546W1TH	UNI7546W	\$656



900 Universal Solid Surface Bowl Top

- Non Porous
- Easy to clean (warm soapy water)
- Same colour all the way through sheet
- Scratches can be sanded out (wet & dry)
- Cuts and sands to desired lengths

Available in Pebble, Snow, Concrete or White

Code	R.R.P (inc GST)	
	Tap Hole	No Tap Hole
UNI9046C1TH	UNI9046C	\$713
UNI9046P1TH	UNI9046P	\$713
UNI9046S1TH	UNI9046S	\$713
UNI9046W1TH	UNI9046W	\$713



1200 Universal Solid Surface Bowl Top

- Non Porous
- Easy to clean (warm soapy water)
- Same colour all the way through sheet
- Scratches can be sanded out (wet & dry)
- Cuts and sands to desired lengths

Available in Pebble, Snow, Concrete or White

Code	R.R.P (inc GST)	
	Tap Hole	No Tap Hole
UNI1246C1TH	UNI1246C	\$796
UNI1246P1TH	UNI1246P	\$796
UNI1246S1TH	UNI1246S	\$796
UNI1246W1TH	UNI1246W	\$796



1500 Universal Solid Surface Double Bowl Top

- Non Porous
- Easy to clean (warm soapy water)
- Same colour all the way through sheet
- Scratches can be sanded out (wet & dry)
- Cuts and sands to desired lengths

Available in Pebble, Snow, Concrete or White

Code	R.R.P (inc GST)	
	Tap Hole	No Tap Hole
UNI1546C1TH	UNI1546C	\$1596
UNI1546P1TH	UNI1546P	\$1596
UNI1546S1TH	UNI1546S	\$1596
UNI1546W1TH	UNI1546W	\$1596



WHITE



GRECO



SLATE

Non Porous

Easy to clean (warm soapy water)

Same colour all the way through sheet

Scratches can be sanded out (wet & dry)

Cuts and sands to desired lengths

750 x 360 ENSUITE Solid Surface 12mm Benchtopy	SSB7536BT (W, G or S)	\$435
750 x 460 Solid Surface 12mm Benchtopy	SSB7546BT (W, G or S)	\$489
900 x 360 ENSUITE Solid Surface 12mm Benchtopy	SSB9036BT (W, G or S)	\$505
900 x 460 Solid Surface 12mm Benchtopy	SSB9046BT (W, G or S)	\$552
1200 x 460 Solid Surface 12mm Benchtopy	SSB1246BT (W, G or S)	\$645
1500 x 460 Solid Surface 12mm Benchtopy	SSB1546BT (W, G or S)	\$772



WHITE



ARMANI

Engineered stone is a stone that is manufactured in a factory. While the main component of engineered stone is quartz, one of the strongest minerals in the world, the rest of it is completely man-made. Engineered stone has been used in homes and as stone benchtops for over 40 years. Resilient and easy to clean

Non porous and hygienically safe

No need for harsh cleaning products

Timeless elegance that offers a long term investment. It's no surprise that people are drawn to the unique beauty of stone for their bathroom benchtop, but the added benefits of durability, practicality, being easy to clean and long-term value make it the first choice for vanities.

Armani Stone Top 750 x 460 x 20mm	STB7546BT-A	\$589
White Stone Top 750 x 460 x 20mm	STB7546BT-W	\$589
Armani Stone Top 900 x 460 x 20mm	STB9046BT-A	\$652
White Stone Top 900 x 460 x 20mm	STB9046BT-W	\$652
Armani Stone Top 1200 x 460 x 20mm	STB1246BT-A	\$745
White Stone Top 1200 x 460 x 20mm	STB1246BT-W	\$745



Vanity Knobs

Code		R.R.P (inc GST)
VIEHDL	Chrome knob for Vienna	\$14
VIEHDL-B	Black knob for Vienna	\$20
T-Bar Brushed Brass		\$20
T-Bar Brushed Nickel		\$20



Uni-Pop Pop-up Waste Chrome/Black/Brushed Nickel

- Universal to suit with or without overflow basins
- Multifit 32mm top with 40mm base
- 7 year product replacement only
- 2 year warranty on black finish
- Chrome plated solid brass, Matte Black, Brushed Nickel or Gun Metal

Code	R.R.P (inc GST)
UNIPOP-CH	\$41
UNIPOP-BL	\$58
UNIPOP-NI	\$69
UNIPOP-GM	\$75



Pop Up Basket Pullout Waste Chrome/Black

- ALSO SUPPLIED WITH DOME CAP OPTION IN BOX
- Completely removable basket waste insert - Plumber code approved
- 7 year product replacement only
- Chrome plated solid brass
- 2 year warranty on Black finish

Code	R.R.P (inc GST)
POBAS32SWC (32mm non-overflow)	\$52
POBAS320FC (32mm overflow)	\$52
POBAS32SW-BL (32mm non-overflow)	\$75
POBAS320F-BL (32mm overflow)	\$75

castano

Effective from the 1st of September 2021 Castano Bathrooms and Kitchens will be updating the warranty periods for products purchased on or after the 1st of September 2021. For details on these warranty details please see below

PRODUCT WARRANT

FOR PRODUCT PURCHASED ON OR AFTER 1ST SEPTEMBER 2021

The benefits given by the warranty set out in this document are in addition to any other rights and remedies you may have under a law in relation to the goods to which the warranty relates.

AUSTRALIAN CONSUMER LAW GUARANTEE

Our goods come with guarantees that cannot be excluded under the Australian Consumer Law. You are entitled to a replacement or refund for a major failure and compensation for any other reasonable foreseeable loss or damage. You are also entitled to have the goods repaired or replaced if the goods fail to be of acceptable quality and the failure does not amount to a major failure.

Range	Model	Warranty	Comments
MIXER	CAPRI ELBA	7	7 year on Cartridge 1 year parts and labour 2 year on BLACK 10 year on flexible tails, product replacement only
	SIERA MILAN POSITANO URBINO	15 15 15 15	15 year on Cartridge 2 year parts and labour 2 year on BLACK or NICKEL or GUN METAL finish 10 year on flexible tails, product replacement only
ACCESSORIES	CAPRI ELBA	10	10 year product replacement only 2 year on BLACK or NICKEL or GUN METAL finish
POP UP WASTE		7	7 year product replacement only 2 year on BLACK or NICKEL finish
SHOWER	CAPRI ELBA MILAN URBINO POSITANO	10	10 year product replacement only, 1 year labour 1 year hose product replacement only 2 year on BLACK or NICKEL or GUN METAL finish
VANITIES (CABINETS & TOPS)	TIRAMI VIENNA CATANI JANINE MAALI GENOA MESINA VERONA MADRID	5	5 year product replacement only 1 year labour
MIRROR WALL UNITS		5	5 year product replacement only 1 year labour
BASINS		5	5 year product replacement only 1 year labour
TOILET SUITE	CERAMICS SEAT	20 5	20 year on vitreous china product replacement only 5 year on UV resistance product replacement only
	INTERNAL VAULES HINGES & RUBBER SEALS	3 1	3 year product replacement only 1 year product replacement and labour (does not cover loose seat)
BATHS	LUCITE BATHS MATTE BATHS	25 10	25 year product replacement only 10 year product replacement only
STAINLESS STEEL FLOOR WASTES	CASTANO	LIFETIME 5	Lifetime structural warranty on stainless 5 year on colour finish
STAINLESS STEEL SINK	CASTANO SINK WASTE	25 1	25 year product replacement only Calabria range 10 year product replacement only on other ranges 1 year labour 1 year replacement only basket waste
STAINLESS STEEL LAUNDRY	CASTANO SINK WASTE	10 1	10 year product replacement only 1 year replacement only basket waste
QUARTZ SINKS	COMISO SINK WASTE	15 1	15 year product replacement only 1 year labour 1 year replacement only basket waste

PRODUCT WARRANTY

FOR PRODUCT PURCHASED BETWEEN 1ST JUNE 2014 AND 31ST AUGUST 2021

The benefits given by the warranty set out in this document are in addition to any other rights and remedies you may have under a law in relation to the goods to which the warranty relates.

AUSTRALIAN CONSUMER LAW GUARANTEE

Our goods come with guarantees that cannot be excluded under the Australian Consumer Law. You are entitled to a replacement or refund for a major failure and compensation for any other reasonable foreseeable loss or damage. You are also entitled to have the goods repaired or replaced if the goods fail to be of acceptable quality and the failure does not amount to a major failure.

RANGE		WARRANTY	COMMENTS
MIXER	CAPRI MILAN ELBA SIERA	7	7 years on Cartridge 2 years parts and labour 2 years on BLACK Finish
	POSITANO URBINO	15	15 years on Cartridge 2 years parts and labour 2 years on BLACK Finish
ACCESSORIES	CAPRI ELBA PIERA	5	5 year replacement parts OR complete product 2 years on BLACK finish
POP UP WASTE		5	5 year replacement parts OR complete product 2 years on BLACK Finish
SHOWER	CAPRI ELBA MILAN	7	7 years replacement parts OR complete product 2 years on BLACK Finish
VANITIES (CABINETS & TOPS)	GENOA MADRID FIRENZE VERONA VIENNA MESINA	5	5 year replacement parts OR complete product
MIRROR WALL UNITS		5	5 year replacement parts OR complete product
CERAMIC BASINS		7	7 year replacement parts OR complete product
TOILET SUITES	CERAMICS	7	7 year replacement parts OR complete product Product is only warranted with the use of 20mm pan connector, anything else will void service warranty
	SEAT / HINGES INTERNALS	2	2 year replacement parts OR complete product
BATHS	LUCITE ACRYLIC	25	25 year replacement parts OR complete product

CLAIMS

Goods that HAVE NOT yet been installed are to be returned to the place of purchase for inspection and appropriate action.

Goods that HAVE been installed and a defect is claimed. We may arrange for a service call at the place of installation to inspect or correct any defect. If the defect is caused by any reason other than manufacturing faults, a service fee may be charged and we will not be liable for the defect.

NOTE: Where the claim is for a 'visible fault' that should have been detected at installation, we will only replace the goods - with removal and re-installation being at your cost

Proof Of Purchase is required.

Warranty is NOT transferable.

Claims against vitreous china product product faulty dimensions or glazing imperfections (that are permitted within AS1976 - Vitreous China used in Sanitary Applications). It is permitted that vitreous china products will vary up to +/- 3mm on any surface and be acceptable products due to the unique conditions of the product's manufacturing process.

EXCLUSIONS

This warranty is for normal domestic use only (not commercial)

Any defect or injury caused by or resulting from misuse, abuse or neglect, accidental damage, improper installation, or installation by a non-licensed plumber.

Any defect of injury caused by or resulting from products installed in a way that was contrary to any applicable national, State or local standards or regulatory requirements.

Any defect, damage or injury caused by or resulting from the effects of hard water, additives, inadequate flushing of system, or failure to clean and replace outlet aerator inserts or other alterations or modifications which affect the reliability of performance of the product.

Damage to finishes by adhesives or sealants

Defects or injury caused by or resulting from installation of product in situations outside of the Australian standards for plumbing installation

Damage or loss that result only because of:

- i. A cause independent of human control that occurs after the goods leave our control
- ii. An act, default or omission of, or any representation made by any person (other than Us or our employee or agent)
- iii. The fact that the price charged by the supplier was higher than our recommended retail price or the average retail price for the goods.

CONSEQUENTIAL LOSS

Subject always to rights you have under the Australian Consumer Law, and to the extent otherwise permitted by law. We will not be liable for any loss or damage to floor coverings, walls, fixtures, furnishings, or any other consequential loss caused by a defect in the Goods. For the avoidance of doubt, the exclusion of consequential loss applies only to loss occurred outside the guarantees provided by the terms of the Australian Consumer Law.

CONTACT

Castano Bathroom & Kitchen Collection Pty Ltd

Unit 2/115 Corymbia Place QLD 4115

PH: 1300 856 887

Email: salesandservice@castano.net.au