



Parklane Interiors
AUSTRALIA

BUSINESS FURNITURE

BESTPRACTICE CERTIFICATION	BESTPRACTICE CERTIFICATION	BESTPRACTICE CERTIFICATION
ISO9001	AS4801	ISO 14001
QUALITY	OH&S	ENVIRONMENT
MANAGEMENT SYSTEM	MANAGEMENT SYSTEM	MANAGEMENT SYSTEM

ISO Accreditation



Receptions.....	Page 6
Credenzas.....	Page 8
Feature Walls/Vertical Gardens	Page 9
Reception Seating	Page 10
Coffee Tables	Page 11
Workstations	Page 12
Soft Wiring	Page 19
Selectric Sit/Stand	Page 22
Workstation Accessories.....	Page 23
Executive Desks.....	Page 26
Boardroom Tables	Page 34
Training/ Meeting Tables.....	Page 36
Education.....	Page 38
Storage.....	Page 40
Lockers.....	Page 42
Metal Storage.....	Page 44
Soft Seating.....	Page 46
Chairs.....	Page 48
Custom Designs.....	Page 52
Colour Swatches.....	Page 54
ACCENT COLLECTION.....	Page 58
Desking.....	Page 58
Tables & Workstations.....	Page 59
Fixed Pedestal	Page 60
Buffet & Bookcase	Page 60
Mobile Pedestal & Filing Cabinet.....	Page 61
Cupboard & Hutch	Page 61
Colour Swatches.....	Page 62
OFFICE SEATING	Page 65
Express Range	Page 66
Locally Upholstered Range	Page 84
BLINDS & CURTAINS	Page 111
Blinds	Page 112
Curtains	Page 116
CAPABILITY STATEMENT	Page 118

Quicksew
total concept creations

Parklane Interiors
AUSTRALIA



eQuote
SYSTEM

Online Product Quoting Tool



NSWBuy
NSW Procurement

Approved NSWBuy Supplier

HOW IT WORKS...

Streamline your quote requests with Quicksew



1

Go to our website www.quicksew.com.au, select "Commercial" and browse our extensive range of products from the dropdown menu.

2

Make your selection, choose a quantity and select "Add to quote" You can then add other products to your quote as required.

3

Simply select the "View eQuotes" button at the top of the page, fill in your details along with any other relevant information and click "Send Your Request" It is that simple!

You will receive a confirmation email with the quote details and our team will be in touch to discuss options and pricing.

Need to know more?
Call our experienced team on 1800 065 068

eQuote
SYSTEM

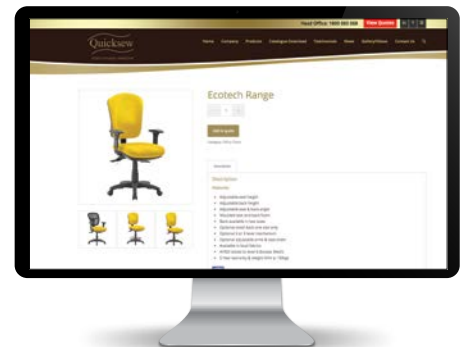

eQuote - Easy Online Quoting Tool

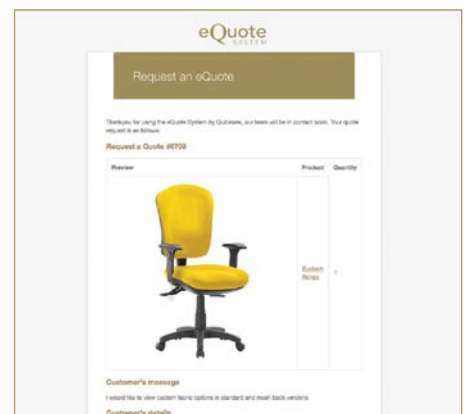

Example eQuote email



2019 SPRING EDIT



SLETRIC DUO 402 - p. 23



VISTA WORKSTATION - p. 21



PLAZA WORKSTATION - p. 15



FORUM WORKSTATION - p. 17



LETO BOARDROOM - p. 34



APOLLO BOARDROOM - p. 34



SUPREME BOARDROOM - p. 35



DELTA BOARDROOM - p. 35



DELTA TABLE - p. 37



FOCUS HIGHBENCH - p. 36



TORO TABLE - p. 37



KATO TABLE - p. 37



LETO LITE - p. 29



HOST MOBILE FLIP TABLE - p. 39



SELETRIC SOLO 201 - p. 22



ECLIPSE COFFEE TABLE - p. 11



ID DESK - p. 28



GEO FORUM - p. 27



STORAGE EXECUTIVE - p. 30



DELTA NOUVEAU - p. 35



MIES OPERATOR - p. 06



MIES SPLIT - p. 06



JAZZ - p.07



AXIS - p. 07



BREEZEWAY GARDEN - p. 53



SLAT CURVED FEATURE WALL - p. 09



VERTICAL GARDEN - p. 53



WALKWAY PLANTER BOX - p. 53



LOLA LOUNGE - p. 47



EADU - p. 47



NOOR LOUNGE - p. 47



KAMINO 2 SEATER - p. 47



YOYO - p. 48



TEKTRON EXECUTIVE - p. 50



BERKELEY - p. 49



MOZZIE - p. 48



CREDENZA - G - p. 08



CREDENZA - C - p. 41



CREDENZA - D - p. 41



CREDENZA - F - p. 41



MOBILE MULTIMEDIA UNIT - p. 38



LUNAR MOBILE PEDESTALS - p. 44



LUNAR TAMBOUR DOOR - p. 45



GARDEN LOCKER - p. 53

MIES MODULAR RECEPTION DESK

Contemporary modular reception desk system. Comes with various options and complimentary additions, it is as easy as picking your options below and adding it to your base size. Proudly Australian designed and made.

Finish Options: **Colour swatches page 54 (Eo Board)**
 Return Options available - **page 07**

Top Options



Base Model

CODE	DIMENSION
MIESRECLP1808	1800W x 850D x 1100H
MIESRECLP2108	2100W x 850D x 1100H

MIES 101 SELECTRIC OPERATOR

Workplace ergonomics has been a major driving force behind the design of our sit/stand reception desk. Danish designed and tested, the Selectric combines superior flexibility and quality in electronically operated true sit/stand desk. It's the ideal solution for changing your working position throughout the day, thus transforming the way you work. The Mies reception counter is available in your choice of 45 colours.

Finish Options: **Colour swatches page 54 (Eo Board)**

CODE	DIMENSION
MISEL210812	2100W x 850D x 705 ~ 1205H

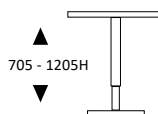

New
DESIGN



(Privacy Panel on the Left Hand from Operators Side shown)

SPLIT RECEPTION DESK

Its linear two tier design creates an inviting interactive space between receptionist and client, making it easily accessible for clients who are in wheelchairs or need to sit for short periods. Ideal for medical practices, hospitals and aged care, fully customizable to any length or height and available in a range of 45 colours.

Return Option available - **page 07**
 Finish Options: **Colour swatches page 54 (Eo Board)**

CODE	DIMENSION
SPLITRECHO1809	1800W x 950D x 1100H
SPLITRECHO2109	2100W x 950D x 1100H
SPLITRECHO2409	2400W x 950D x 1100H

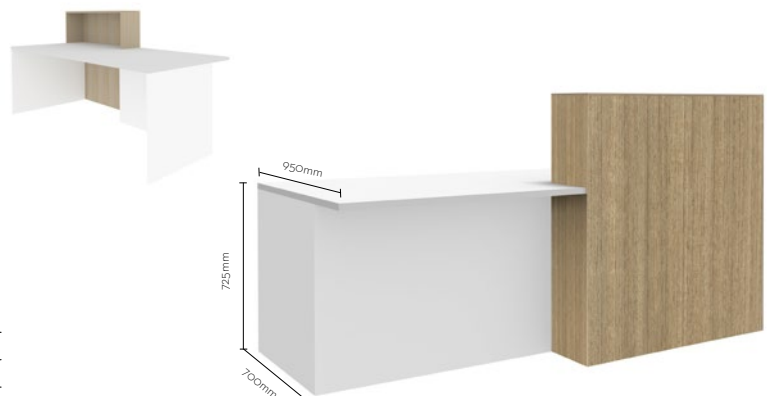

(Feature high hob on Left Hand from Operatos Side shown)

AXIS RECEPTION DESK

Make an impression and stand out with a show stopping reception. The Axis is our original design, proudly Australian Made with careful consideration to detail in its joins and overall aesthetic. Customizable to any size, a choice of 45 colours, return options also available.

Finish Options: **Colour swatches page 54 (Eo Board)**

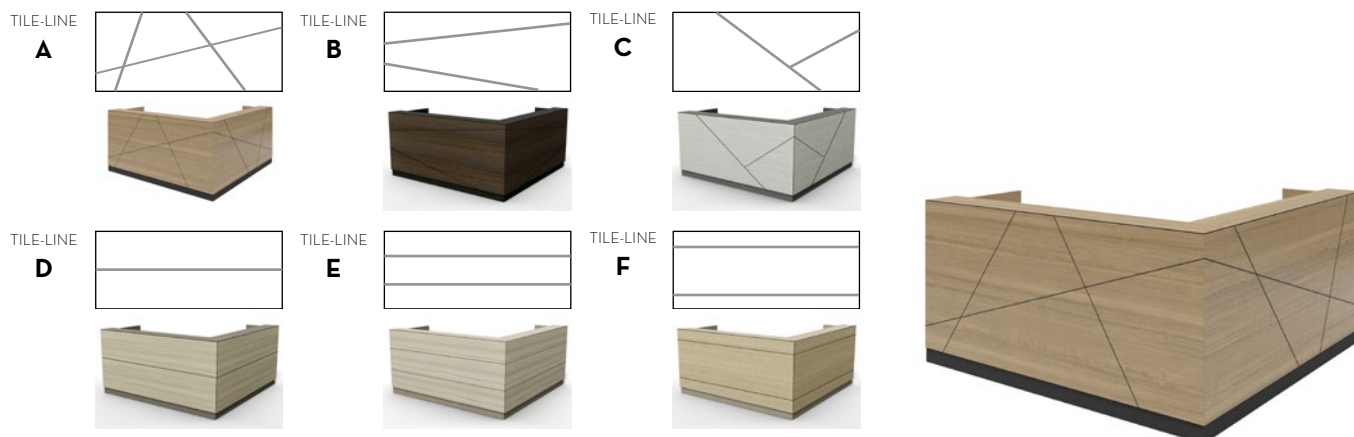

CODE	DIMENSION
AXISR21	(2100W x 900D) x (1800W x 600D) x 1072H
AXISR24	(2400W x 900D) x (1800W x 600D) x 1072H

APEX-LITE RECEPTION DESK

Simplified version of the Apex reception counter. Designed with user & visitor comfort in mind. Simple design creates a reception area that is both functional and attractive. Flat panel construction & easy to assemble.

Return Options available - page 07

Finish Options: **Colour swatches page 54 (Eo Board)**

CODE	DIMENSION
ALRD18	1800W x 925D x 1100H
ALRD21	2100W x 925D x 1100H
ALRD24	2400W x 925D x 1100H



JAZZ RECEPTION DESK

The Jazz Reception desk is inviting, friendly and opens in its design. Proudly Australian designed and made. With elegant long linear lines, combining lap and birds-mouth joints, the Jazz is an absolute stunner! Available in a choice of 45 colours and customizable in any size, the Jazz speaks for herself as soon as you walk through the door; all you can think is WOW!

Finish Options: **Colour swatches page 54 (Eo Board)**

CODE	DIMENSION
JZREC240811	2400W x 850D x 1100H
JZREC270811	2700W x 850D x 1100H
JZREC300811	3000W x 850D x 1100H



RETURN

Suitable for Mies, Split & Apex - Lite Reception

Finish Options: **Refer to the Colour swatches page 54 (Eo Board)**

RETURN	CODE	DIMENSION
A	RETURE09A	900W x 600D x 725H
	RETURE012A	1200W x 600D x 725H
B	RETURE09B	900W x 600D x 1100H
	RETURE012B	1200W x 600D x 1100H
C	RETURE09C	900W x 600D x 1100H
	RETURE012C	1200W x 600D x 1100H

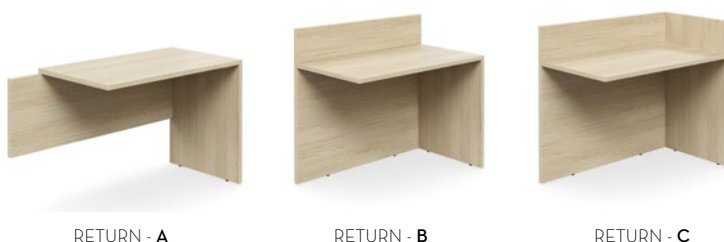

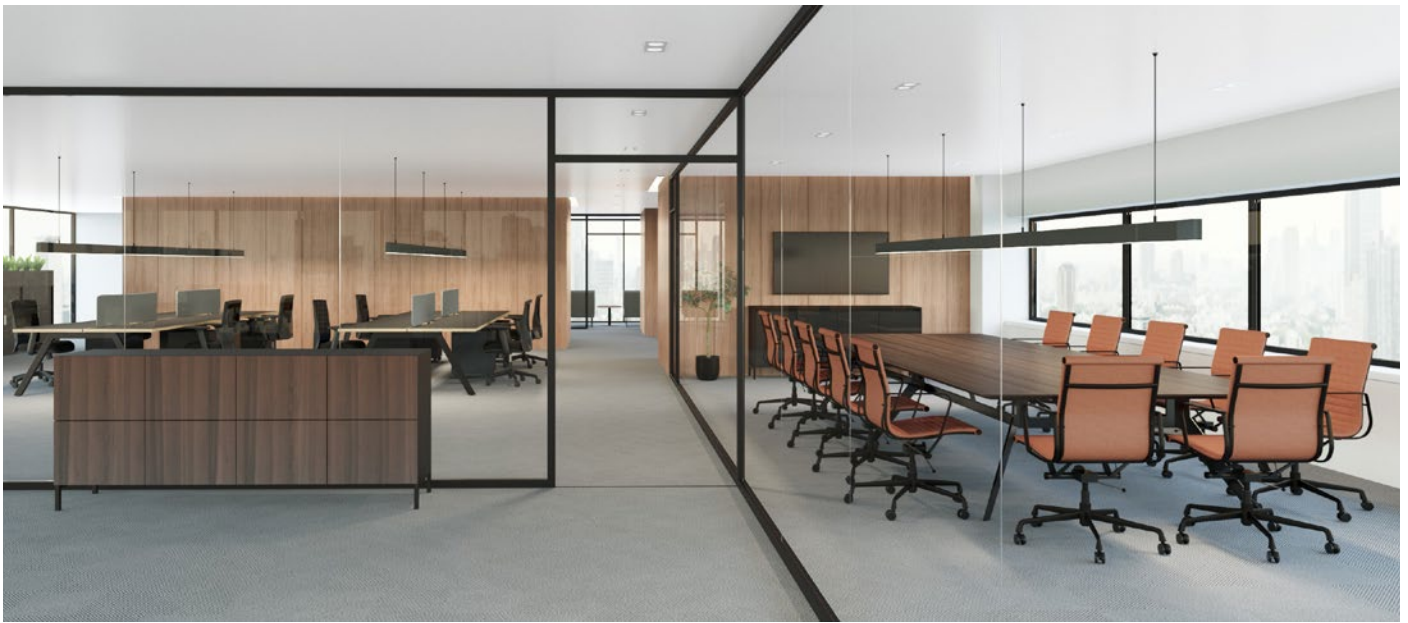

CREDENZAS

A good functional space always requires a sturdy yet good-looking credenza. In a boardroom or meeting room where furniture is at the centre of the room, a credenza adds practicality in storage and also anchors the room with a stunning showpiece.

Lock Options: refer to page 41

Finish Options: Colour swatches page 54 (EO Board)

*Reference for more Credenza Options - page 41

CREDENZA - G New DESIGN

- Doors + Drawers
- Push Open System



CODE	DIMENSION	STYLE
RECCREG2204	2260W x 450D x 900H	4 Doors + 3 Drawers

CREDENZA - H New DESIGN

- Birdsmouth Joints Top & Sides
- Finger Pull Door
- Soft Closing Doors
- Black / White tubular steel feet



CODE	DIMENSION	DOORS
RECCREH1504	1500W x 450D x 900H	4
RECCREH1804	1800W x 450D x 900H	4
RECCREH2104	2100W x 450D x 900H	4
RECCREH2404	2400W x 450D x 900H	6

CREDENZA - B

- Floating top
- Push Open System
- Adjustable feet



CODE	DIMENSION	DOORS
RECCREB1804	1800W x 450D x 900H	4
RECCREB2104	2100W x 450D x 900H	4
RECCREB2404	2400W x 450D x 900H	6

CREDENZA - D

- Title-line doors
- Black / White tubular steel feet
- Soft Closing Doors



CODE	DIMENSION	DOORS
RECCRED1804	1800W x 450D x 900H	4
RECCRED2104	2100W x 450D x 900H	4
RECCRED2404	2400W x 450D x 900H	6

CREDENZA - C

- Doors + Open unit
- Planter box available (Refer to page 43)



CODE	DIMENSION	DOORS
RECCREC1804	1800W x 450D x 900H	4
RECCREC2104	2100W x 450D x 900H	4
RECCREC2404	2400W x 450D x 900H	6

CREDENZA - F

- 2 Tone finish (Option)
- 2 Tier construction
- Adjustable feet
- Soft Closing Doors



CODE	DIMENSION	DOORS
RECCREF1804	1800W x 450D x 900H	4
RECCREF2104	2100W x 450D x 900H	4
RECCREF2404	2400W x 450D x 900H	6



FEATURE WALLS / VERTICAL GARDENS

Planter boxes, garden beds, slat walls, are all the rage at the moment in the commercial workspace environment and we have you covered. They bring life and added texture to any fit-out, new or existing.

Melamine Finish Options: Colour swatches page 54 (Eo Board)

WALKWAY PLANTER BOX

New DESIGN

- Frame Finish: Powder - coated Black / White
- Artificial Dracaena Plants included



CODE	DIMENSION
WLKPL0905	900W x 450D x 810H
OPTION	Plants + Pebbles or Barks

BREEZEWAY VERTICAL GARDEN

New DESIGN

- Frame Finish: Powder - coated Black / White
- 18mm Melamine Panels: **Colour Swatch page 54 (Eo Board)**
- *Artificial Plant Options: **Refer to page 53**



(Image shown two 1200W units)

CODE	DIMENSION
BREPL1235	1200W x 350D x 1800H

SLAT WALL

200D x 2400 ~ 2700H

- 25mm Melamine Structure
- Custom Height



Straight Slat
Per metre of width - 12 Slats



Angle Slat
Per metre of width - 6 Slats

VERTICAL GARDEN WALL

- 25mm Melamine Structure
- * Artificial Plant Options: **Refer to page 53**



(2700W shown)

CODE	DIMENSION
VGW62718	1800W x 200D x 2700H
VGW62721	2100W x 200D x 2700H
VGW62724	2400W x 200D x 2700H
VGW62727	2700W x 200D x 2700H

SLAT CURVED FEATURE WALL

- 90 Degree Side Angle
- 25mm Melamine Structure
- Made to measure

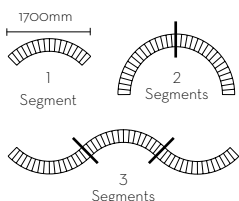

(2700H shown)

AXIS FEATURE WALL

- 18mm Melamine Structure
- Made to measure



TILE-LINE WALL

- 18mm Melamine Structure
- Made to measure



Plant Holder

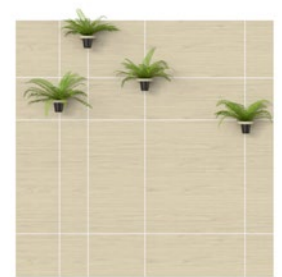

(Plants included)



RECEPTION SEATING (More Soft Seating Options - page 46)

Soft seating and breakout chairs are becoming more and more important in any breakout area. Visitor chairs and sofas can create comforting warmth and a welcoming environment to any organization. **Fully assembled for all seating.**

NOOR LOUNGE

New DESIGN



Low Back



High Back

CODE	DIMENSION
ICNOLBGR	1500W x 750D x 800H (Low Back)
ICNOHBGR	1500W x 750D x 1250H (High Back)

EADU CHAIR



CODE	DIMENSION
ICEDAR	690W x 780D x 830H

KONNECT LOUNGE



Corner L / R



Middle



Ottoman

CODE	DIMENSION
ICKOLDG	750W x 750D x 710H (Corner)
ICKOSBDG	550W x 750D x 710H (Middle)
ICKOOTDG	550W x 750D x 420H (Ottoman)

KAMINO LOUNGE



1 Seater



2 Seater

CODE	DIMENSION
ICKM1SGRGR	880W x 610D x 760H (1 Seater)
ICKM2SGRGR	1380W x 610D x 760H (2 Seater)

LOLA CHAIR

New DESIGN



CODE	DIMENSION
ICLO1SLGN	760W x 650D x 760H

BOON LOUNGE



CODE	DIMENSION
ICBOSMG	1600W x 800D x 1200H

COFFEE TABLES

A coffee table is the centrepiece of any soft seated breakout area, and is required to be as stylish as the chair itself. With a choice of 45 colour tops, you will be able to create any look.

Melamine Finish Options: Colour swatches page 54 (Eo Board)

TOP PROFILE OPTIONS //



Standard



Premium

ECLIPSE COFFEE TABLE

New DESIGN

Top: 18mm Melamine
Base: Black Steel Round Tube



CODE	DIMENSION
IMECCT05	Ø500 x 500H
OPTION	Fully Assembled

ECLIPSE COFFEE TABLE

New DESIGN

Top: 18mm Melamine
Base: Black Steel Round Tube



CODE	DIMENSION
IMECCT09	Ø900 x 450H
OPTION	Fully Assembled

AIR - ROUND COFFEE TABLE

Top: 18mm Melamine
Base: 10x20mm Polished Stainless Steel / Powder - coated Black or White



CODE	DIMENSION
IMCRRD0P06	Ø600 x 450H
IMCRRD0P12	Ø1200 x 450H
OPTION	Fully Assembled

AIR - RECTANGLE COFFEE TABLE

Top: 18mm Melamine
Base: 10x20mm Polished Stainless Steel / Powder - coated Black or White



CODE	DIMENSION
IMCRSQ12PO	1200W x 600D x 450H (Rectangle)
IMCROV12PO	1300W x 650D x 450H (Oval)
OPTION	Fully Assembled

VERSE COFFEE TABLE

Top: 18mm Melamine
Base: Polished Stainless Steel / Black



CODE	DIMENSION
IMVSCTBAPO	Ø600 x 450H (Round)
IMVSRTBAPO	600W x 600D x 450H (Square)
OPTION	Fully Assembled

PLANK COFFEE TABLE

Top: 25mm Melamine
Base: 25mm & 18mm Melamine construction



CODE	DIMENSION
PLANKCT	750W x 600D x 450H
IFSOSQ12PO	Custom Dimension Available

SOTO GLASS

Top: 12mm Tempered Clear Glass
Base: 38mm Polished Stainless Steel



CODE	DIMENSION
IFSOSQ06PO	600W x 600D x 400H (Square)
IFSOSQ12PO	1200W x 600D x 400H (Rectangle)
OPTION	Fully Assembled

KONNECT BOX

- Charging box to suit Konnect Lounge
- Top & Base: 18mm Melamine construction with Lap Joints
- Finish Options: Colour swatches page 54 (Eo Board)



Pop - Up Indesk:
- 1 x Auto switch GPO
- 2 x USB Charger



Wireless Pads:
- 1 x Wireless charging pad
- 2 x USB Fast Charger

CODE	DIMENSION
KONBOX	300W x 750D x 380H
KONBOXPU	Konnect Box + Pop-Up
KONBOXWI	Konnect Box + Wi Pad



WORKSTATIONS

PLAZA - OPTIC WORKSTATIONS

The plaza features a 50 x 50mm steel tube leg system that is easy to assemble, making it an easy solution for any office fit out. Its lineal look and timeless style can be configured to suit your office work environment.

Workstation with scalloped tops included

Table Top Finish Options:
White / Colour swatches page 54 (EO Board)
 Accessory Options: Refer to page 23

OPTIC Screen System

350H (Imported Screen)

- System Type: Solid Panel
- Screen Brackets Included
- House Fabric Colour: Charcoal

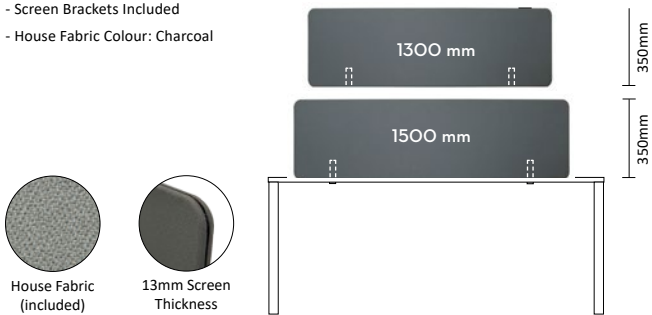

CODE	DIMENSION
ISOUTS13CH	1300W x 13D x 350H
ISOUTS15CH	1500W x 13D x 350H

600H (Local Made Screen) **New**

- System Type: Solid Panel
- Screen Brackets Included
- House Fabric Colour: Charcoal

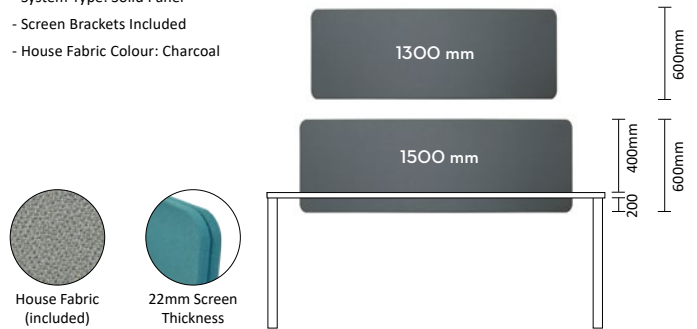

CODE	DIMENSION
ISOUTS1306	1300W x 22D x 600H
ISOUTS1506	1500W x 22D x 600H
FABRIC OPTION	Rim Trilogy 1 add +

Plaza Desk (Top without Scallop)



Top view



Base Finish: White / Black - arriving in December

CODE	OVERALL SIZE
PLZDES1507	1500L x 750D x 725H
PLZDES1807	1800L x 750D x 725H

Plaza Desk & Return (Top without Scallop)



Top view

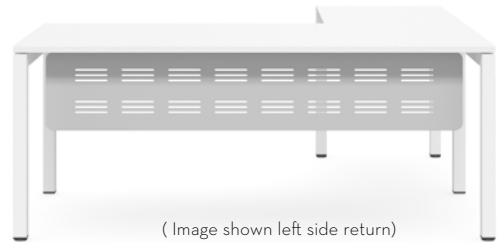

(Image shown left side return)

Base Finish: White / Black - arriving in December
 Modesty: White / Powder - coated Black
 Cable Hole to your preferred placement (included)

CODE	DESK	RETURN
PLZWS15071506	(1500L x 750D) x	(1500L x 600D) x 725H
PLZWS18071806	(1800L x 750D) x	(1800L x 600D) x 725H
PLZWS18091806	(1800L x 900D) x	(1800L x 600D) x 725H

Bench Single Sided x 1 pod



Top view



(Image shown 600H OPTIC Screen)

Base Finish: White / Black - arriving in December

Prices include 1 OPTIC 350H Screen

CODE	TOP SIZE	OVERALL SIZE	POD
PLZDES1507	1500L	1500L x 750D x 725H	1
PLZDES1807	1800L	1800L x 750D x 725H	1

Prices include 1 OPTIC 600H Screen

CODE	TOP SIZE	OVERALL SIZE	POD
PLZDES1507	1500L	1500L x 750D x 725H	1
PLZDES1807	1800L	1800L x 750D x 725H	1

Bench Single Sided x 2 pod



Top view



(Image shown 600H OPTIC Screen)

Base Finish: White / Black - arriving in December

Prices include 2 OPTIC 350H Screens

CODE	TOP SIZE	OVERALL SIZE	POD
PLZDES3007	1500L	3000L x 750D x 725H	2
PLZDES3607	1800L	3600L x 750D x 725H	2

Prices include 2 OPTIC 600H Screens

CODE	TOP SIZE	OVERALL SIZE	POD
PLZDES3007	1500L	3000L x 750D x 725H	2
PLZDES3607	1800L	3600L x 750D x 725H	2

Bench Double Sided x 2 pod



Top view



(Image shown 600H OPTIC Screen)

Base Finish: White / Black - arriving in December

Prices include 1 OPTIC 350H Screen

CODE	TOP SIZE	OVERALL SIZE	POD
PLZ2SYS15	1500L	1500L x 1500D x 725H	2
PLZ2SYS18	1800L	1800L x 1500D x 725H	2

Prices include 1 OPTIC 600H Screen

CODE	TOP SIZE	OVERALL SIZE	POD
PLZ2SYS15	1500L	1500L x 1500D x 725H	2
PLZ2SYS18	1800L	1800L x 1500D x 725H	2

Bench Double Sided x 4 pod

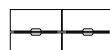

Top view



(Image shown 600H OPTIC Screen)

Base Finish: White / Black - arriving in December

Prices include 2 OPTIC 350H Screens

CODE	TOP SIZE	OVERALL SIZE	POD
PLZ4SYS3015	1500L	3000L x 1500D x 725H	4
PLZ4SYS3615	1800L	3600L x 1500D x 725H	4

Prices include 2 OPTIC 600H Screens

CODE	TOP SIZE	OVERALL SIZE	POD
PLZ4SYS3015	1500L	3000L x 1500D x 725H	4
PLZ4SYS3615	1800L	3600L x 1500D x 725H	4

Bench Double Sided x 6 pod

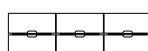

Top view



(Image shown 600H OPTIC Screen)

Base Finish: White / Black - arriving in December

Prices include 3 OPTIC 350H Screens

CODE	TOP SIZE	OVERALL SIZE	POD
PLZ6SYS4515	1500L	4500L x 1500D x 725H	6
PLZ6SYS5415	1800L	5400L x 1500D x 725H	6

Prices include 3 OPTIC 600H Screens

CODE	TOP SIZE	OVERALL SIZE	POD
PLZ6SYS4515	1500L	4500L x 1500D x 725H	6
PLZ6SYS5415	1800L	5400L x 1500D x 725H	6

4 Way Workstation (Desk & Return shown)



Top view

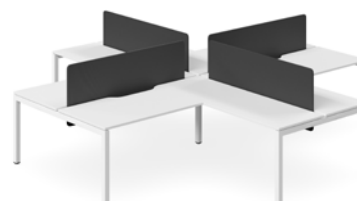

(Image shown 600H OPTIC Screen)

Base Finish: White / Black - arriving in December

Radial or Splayed Tops

Prices include 4 OPTIC 350H Screens

CODE	TOP SIZE	OVERALL SIZE	POD
PLZ4XSYS18071807	1800L	1800L x 750D x 1800L x 750D x 725H	4

Prices include 4 OPTIC 600H Screens

CODE	TOP SIZE	OVERALL SIZE	POD
PLZ4XSYS18071807	1800L	1800L x 750D x 1800L x 750D x 725H	4



PLAZA - TEK 30 WORKSTATIONS

The plaza features a 50 x 50mm steel tube leg system that is easy to assemble, making it an easy solution for any office fit out. Its lineal look and timeless style can be configured to suit your office work environment.

Workstation with scalloped tops included

Table Top Finish Options:
White / Colour swatches page 54 (Eo Board)
 Accessory Options: Refer to page 23

TEK 30 Screen System

Power / Data Ducting:
 30mm Tek is a non-ducted system, if cabling is required external cabling can be supplied by means of cable baskets fitted under desks with soft-wire leads & outlets.

500H Screen

- System Type: Solid Panel
- House Fabric Colour: Charcoal
- Screen Framework: White or Powder-coated Black
- Screen Brackets Included

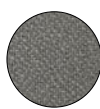

House Fabric (included)



30mm Screen Thickness

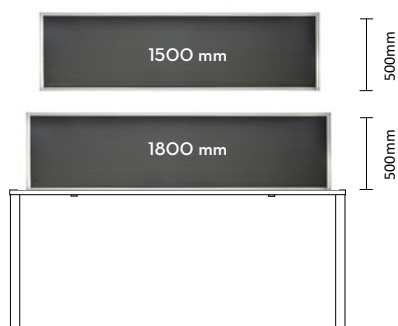

CODE	DIMENSION
ISE30P1505	1500W x 30D x 500H
ISE30P1805	1800W x 30D x 500H
FABRIC OPTION	Rim Trilogy 1 add +

700H Screen

- System Type: Solid Panel
- House Fabric Colour: Charcoal
- Screen Framework: White or Powder-coated Black
- Screen Brackets Included

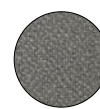

House Fabric (included)



30mm Screen Thickness

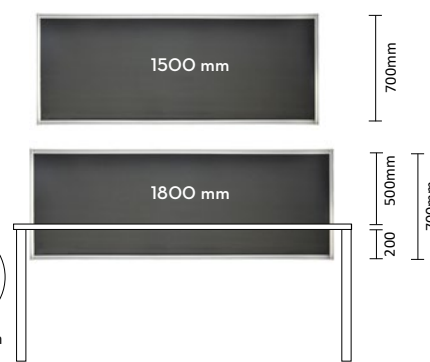

CODE	DIMENSION
ISE30P1507	1500W x 30D x 700H
ISE30P1807	1800W x 30D x 700H
FABRIC OPTION	Rim Trilogy 1 add +

Plaza Desk (Top without Scalloped)



Top view



Base Finish: White / Black - arriving in December

CODE	OVERALL SIZE
PLZDES1507	1500L x 750D x 725H
PLZDES1807	1800L x 750D x 725H

Plaza Desk & Return (Top without Scalloped)



Top view

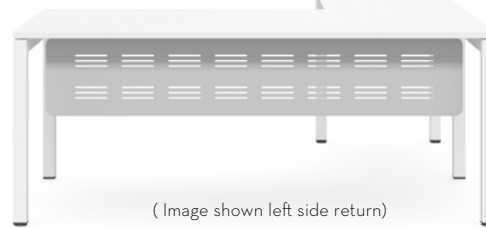

(Image shown left side return)

Base Finish: White / Black - arriving in December
 Modesty: White / Powder-coated Black
 Cable Hole to your preferred placement (included)

CODE	DESK	RETURN
PLZWS15071506	(1500L x 750D) x	(1500L x 600D) x 725H
PLZWS18071806	(1800L x 750D) x	(1800L x 600D) x 725H
PLZWS18091806	(1800L x 900D) x	(1800L x 600D) x 725H

Bench Single Sided x 1 pod



Top view

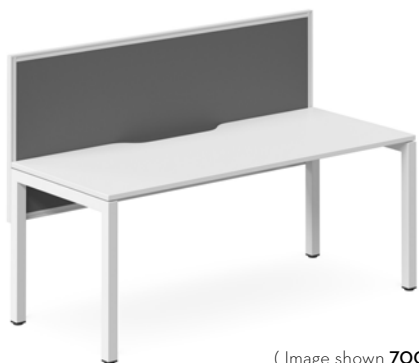

(Image shown 700H TEK Screen)

Base Finish: White / Black - arriving in December

Prices include 1 TEK 700H Screen

CODE	TOP SIZE	OVERALL SIZE	POD
PLZDES1507	1500L	1500L x 750D x 725H	1
PLZDES1807	1800L	1800L x 750D x 725H	1

Bench Single Sided x 2 pod

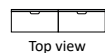

Top view

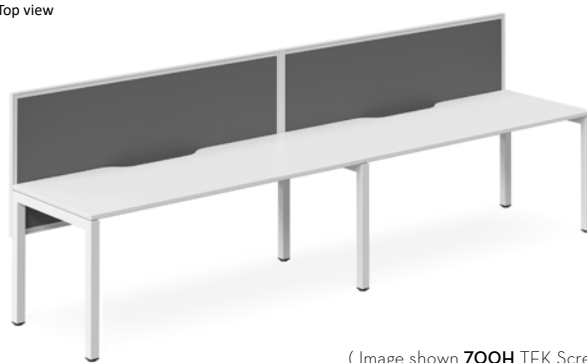

(Image shown 700H TEK Screens)

Base Finish: White / Black - arriving in December

Prices include 2 TEK 700H Screens

CODE	TOP SIZE	OVERALL SIZE	POD
PLZDES3007	1500L	3000L x 750D x 725H	2
PLZDES3607	1800L	3600L x 750D x 725H	2

Bench Double Sided x 2 pod



Top view

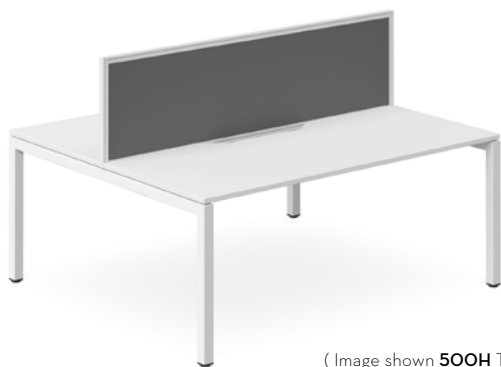

(Image shown 500H TEK Screen)

Base Finish: White / Black - arriving in December

Prices include 1 TEK 500H Screen

CODE	TOP SIZE	OVERALL SIZE	POD
PLZ2SYS15	1500L	1500L x 1500D x 725H	2
PLZ2SYS18	1800L	1800L x 1500D x 725H	2

Bench Double Sided x 4 pod

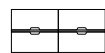

Top view

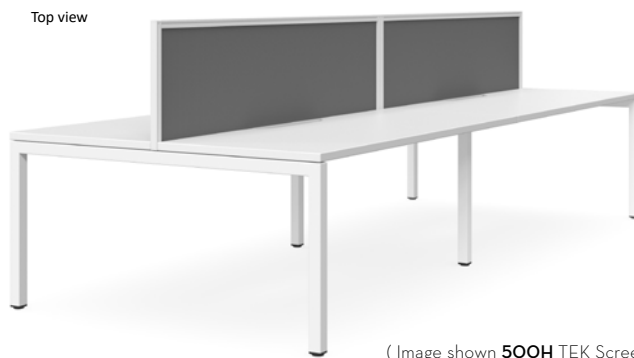

(Image shown 500H TEK Screens)

Base Finish: White / Black - arriving in December

Prices include 2 TEK 500H Screens

CODE	TOP SIZE	OVERALL SIZE	POD
PLZ4SYS3015	1500L	3000L x 1500D x 725H	4
PLZ4SYS3615	1800L	3600L x 1500D x 725H	4

Bench Double Sided x 6 pod



Top view



(Image shown 500H TEK Screens)

Base Finish: White / Black - arriving in December

Prices include 3 TEK 500H Screens

CODE	TOP SIZE	OVERALL SIZE	POD
PLZ6SYS4515	1500L	4500L x 1500D x 725H	6
PLZ6SYS415	1800L	5400L x 1500D x 725H	6

4 Way Workstation (Desk & Return shown)



Top view

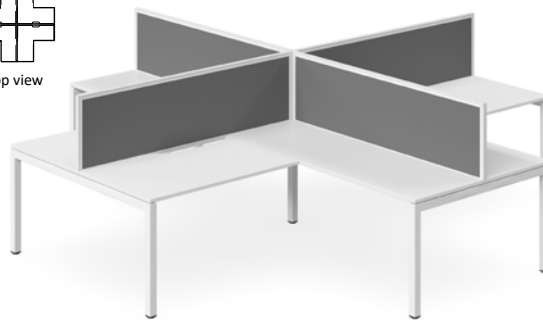

(Image shown 500H TEK Screens)

Base Finish: White / Black - arriving in December

Radial or Splayed Tops

Prices include 4 TEK 500H Screens

CODE	TOP SIZE	OVERALL SIZE	POD
PLZ4SYS18071807	1800L	1800L x 750D x 1800L x 750D x 725H	4

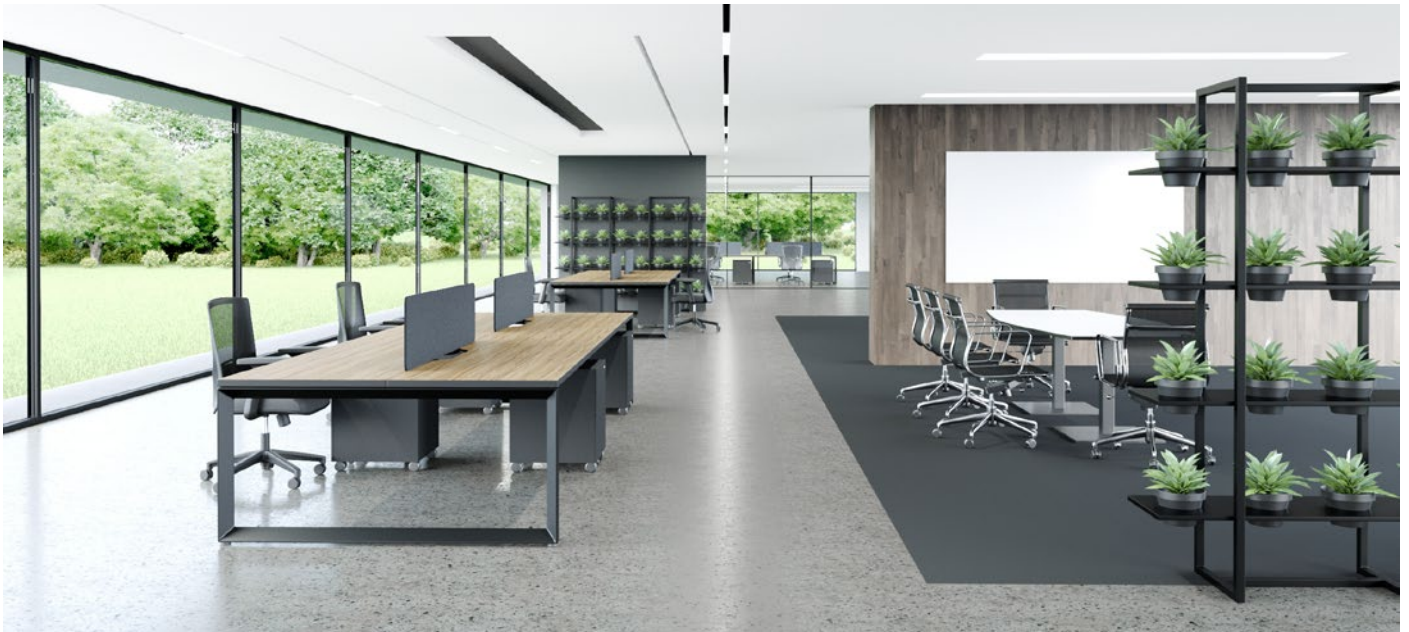

FORUM - OPTIC WORKSTATIONS

The forum comprises of a sturdy triangular profile leg featuring a 6mm sleek shadow line making it a sleek and modern solution. It is easy to assemble in any configuration to suit your office environment.

Workstation with scalloped tops included

Table Top Finish Options:
White / Colour swatches page 54 (Eo Board)
 Accessory Options: Refer to page 23

OPTIC Screen System

350H (Imported Screen)

- System Type: Solid Panel
- Screen Brackets Included
- House Fabric Colour: Charcoal

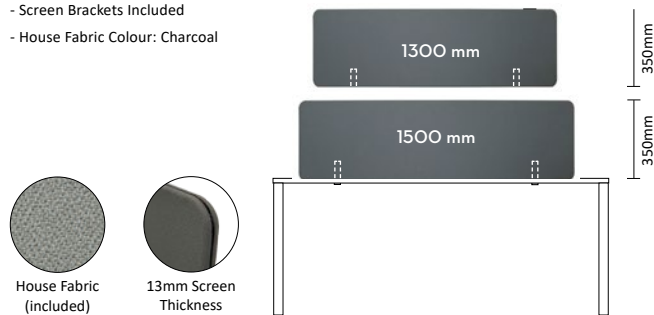

CODE	DIMENSION
ISOOTS13CH	1300W x 13D x 350H
ISOOTS15CH	1500W x 13D x 350H

600H (Local Made Screen) **New**

- System Type: Solid Panel
- Screen Brackets Included
- House Fabric Colour: Charcoal

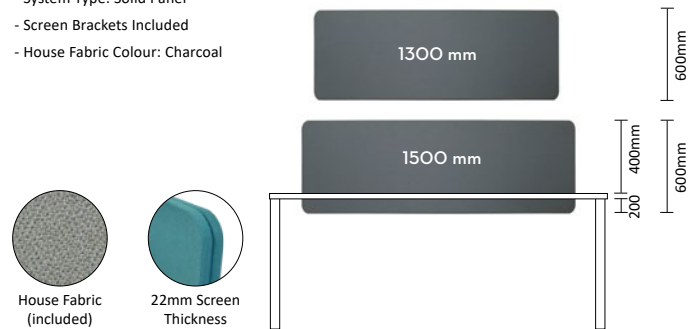

CODE	DIMENSION
ISOOTS1306	1300W x 22D x 600H
ISOOTS1506	1500W x 22D x 600H
FABRIC OPTION	Rim Trilogy 1 add +

Forum Desk (Top without Scallop)

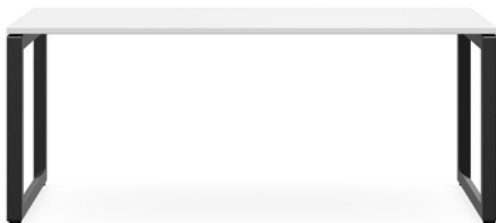

Base Finish: White / Black

CODE	OVERALL SIZE
FORDES1507	1500L x 750D x 725H
FORDES1807	1800L x 750D x 725H

Forum Desk & Return (Top without Scallop)

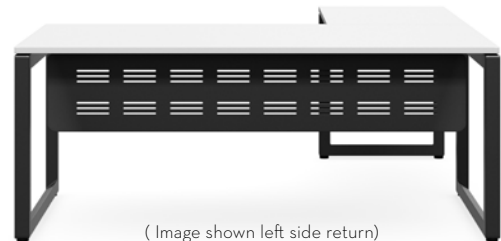

Base Finish: White / Black
 Modesty: White / Powder - coated Black
 Cable Hole to your preferred placement (included)

CODE	DESK	RETURN
FORWS15071506	(1500L x 750D) x	(1500L x 600D) x 725H
FORWS18071806	(1800L x 750D) x	(1800L x 600D) x 725H
FORWS18091806	(1800L x 900D) x	(1800L x 600D) x 725H

Bench Single Sided x 1 pod



(Image shown 600H OPTIC Screen)

Base Finish: White / Black

Prices include 1 OPTIC 350H Screen

CODE	TOP SIZE	OVERALL SIZE	POD
FORDES1507	1500L	1500L x 750D x 725H	1
FORDES1807	1800L	1800L x 750D x 725H	1

Prices include 1 OPTIC 600H Screen

CODE	TOP SIZE	OVERALL SIZE	POD
FORDES1507	1500L	1500L x 750D x 725H	1
FORDES1807	1800L	1800L x 750D x 725H	1

Bench Single Sided x 2 pod



(Image shown 600H OPTIC Screen)

Base Finish: White / Black

Prices include 2 OPTIC 350H Screens

CODE	TOP SIZE	OVERALL SIZE	POD
FORDES3007	1500L	3000L x 750D x 725H	2
FORDES3607	1800L	3600L x 750D x 725H	2

Prices include 2 OPTIC 600H Screens

CODE	TOP SIZE	OVERALL SIZE	POD
FORDES3007	1500L	3000L x 750D x 725H	2
FORDES3607	1800L	3600L x 750D x 725H	2

Bench Double Sided x 2 pod



(Image shown 600H OPTIC Screen)

Base Finish: White / Black

Prices include 1 OPTIC 350H Screen

CODE	TOP SIZE	OVERALL SIZE	POD
FOR2SYS15	1500L	1500L x 1500D x 725H	2
FOR2SYS18	1800L	1800L x 1500D x 725H	2

Prices include 1 OPTIC 600H Screen

CODE	TOP SIZE	OVERALL SIZE	POD
FOR2SYS15	1500L	1500L x 1500D x 725H	2
FOR2SYS18	1800L	1800L x 1500D x 725H	2

Bench Double Sided x 4 pod

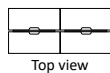

(Image shown 600H OPTIC Screen)

Base Finish: White / Black

Prices include 2 OPTIC 350H Screens

CODE	TOP SIZE	OVERALL SIZE	POD
FOR4SYS3015	1500L	3000L x 1500D x 725H	4
FOR4SYS3615	1800L	3600L x 1500D x 725H	4

Prices include 2 OPTIC 600H Screens

CODE	TOP SIZE	OVERALL SIZE	POD
FOR4SYS3015	1500L	3000L x 1500D x 725H	4
FOR4SYS3615	1800L	3600L x 1500D x 725H	4

Bench Double Sided x 6 pod

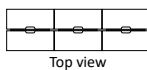

(Image shown 600H OPTIC Screen)

Base Finish: White / Black

Prices include 3 OPTIC 350H Screens

CODE	TOP SIZE	OVERALL SIZE	POD
FOR6SYS4515	1500L	4500L x 1500D x 725H	6
FOR6SYS5415	1800L	5400L x 1500D x 725H	6

Prices include 3 OPTIC 600H Screens

CODE	TOP SIZE	OVERALL SIZE	POD
FOR6SYS4515	1500L	4500L x 1500D x 725H	6
FOR6SYS5415	1800L	5400L x 1500D x 725H	6

4 Way Workstation (Desk & Return shown)



(Image shown 600H OPTIC Screen)

Base Finish: White / Black

Radial or Splayed Tops

Prices include 4 OPTIC 350H Screens

CODE	TOP SIZE	OVERALL SIZE	POD
PLZ4XSYS 18071807	1800L	1800L x 750D x 1800L x 750D x 725H	4

Prices include 4 OPTIC 600H Screens

CODE	TOP SIZE	OVERALL SIZE	POD
PLZ4XSYS 18071807	1800L	1800L x 750D x 1800L x 750D x 725H	4



FORUM - TEK 30 WORKSTATIONS

The forum comprises of a sturdy triangular profile leg featuring a 6mm sleek shadow line making it a sleek and modern solution. It is easy to assemble in any configuration to suit your office environment.

Workstation with scalloped tops included

Table Top Finish Options:
White / Colour swatches page 54 (EO Board)
 Accessory Options: Refer to page 23

TEK 30 Screen System

Power / Data Ducting:
 30mm Tek is a non-ducted system, if cabling is required external cabling can be supplied by means of cable baskets fitted under desks with soft-wire leads & outlets.

500H Screen

- System Type: Solid Panel
- House Fabric Colour: Charcoal
- Screen Framework: White or Powder-coated Black
- Screen Brackets Included

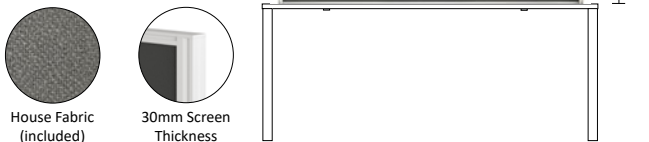

CODE	DIMENSION
ISE30P1505	1500W x 30D x 500H
ISE30P1805	1800W x 30D x 500H
FABRIC OPTION	Rim Trilogy 1 add +

700H Screen

- System Type: Solid Panel
- House Fabric Colour: Charcoal
- Screen Framework: White or Powder-coated Black
- Screen Brackets Included



CODE	DIMENSION
ISE30P1507	1500W x 30D x 700H
ISE30P1807	1800W x 30D x 700H
FABRIC OPTION	Rim Trilogy 1 add +

Forum Desk (Top without Scallop)

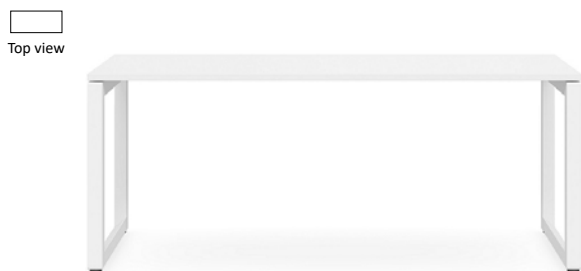

Base Finish: White / Black

CODE	OVERALL SIZE
FORDES1507	1500L x 750D x 725H
FORDES1807	1800L x 750D x 725H

Forum Desk & Return (Top without Scallop)

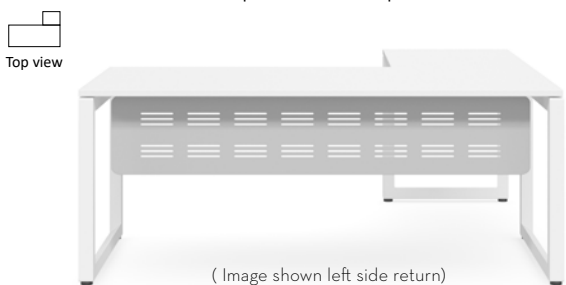

Base Finish: White / Black
 Modesty: White / Powder-coated Black
 Cable Hole to your preferred placement (included)

CODE	DESK	RETURN
FORWS15071506	(1500L x 750D)	(1500L x 600D) x 725H
FORWS18071806	(1800L x 750D)	(1800L x 600D) x 725H
FORWS18091806	(1800L x 900D)	(1800L x 600D) x 725H

Bench Single Sided x 1 pod



Top view



(Image shown 700H TEK Screen)

Base Finish: White / Black

Prices include 1 TEK 700H Screen

CODE	TOP SIZE	OVERALL SIZE	POD
FORDES1507	1500L	1500L x 750D x 725H	1
FORDES1807	1800L	1800L x 750D x 725H	1

Bench Single Sided x 2 pod

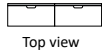

Top view



(Image shown 700H TEK Screens)

Base Finish: White / Black

Prices include 2 TEK 700H Screens

CODE	TOP SIZE	OVERALL SIZE	POD
FORDES3007	1500L	3000L x 750D x 725H	2
FORDES3607	1800L	3600L x 750D x 725H	2

Bench Double Sided x 2 pod



Top view

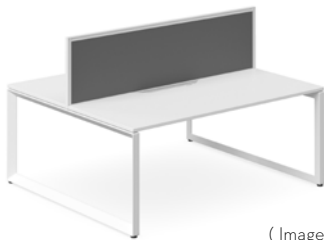

(Image shown 500H TEK Screen)

Base Finish: White / Black

Prices include 1 TEK 500H Screen

CODE	TOP SIZE	OVERALL SIZE	POD
FOR2SYS15	1500L	1500L x 1500D x 725H	2
FOR2SYS18	1800L	1800L x 1500D x 725H	2

Bench Double Sided x 4 pod

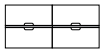

Top view



(Image shown 500H TEK Screens)

Base Finish: White / Black

Prices include 2 TEK 500H Screens

CODE	TOP SIZE	OVERALL SIZE	POD
FOR4SYS3015	1500L	3000L x 1500D x 725H	4
FOR4SYS3615	1800L	3600L x 1500D x 725H	4

Bench Double Sided x 6 pod

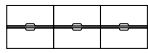

Top view



(Image shown 500H TEK Screens)

Base Finish: White / Black

Prices include 3 TEK 500H Screens

CODE	TOP SIZE	OVERALL SIZE	POD
FOR6SYS4515	1500L	4500L x 1500D x 725H	6
FOR6SYS4518	1800L	5400L x 1500D x 725H	6

4 Way Workstation (Desk & Return shown)



Top view

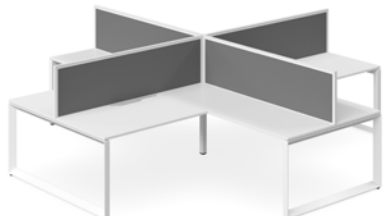

(Image shown 500H TEK Screens)

Base Finish: White / Black

Radial or Splayed Tops

Prices include 4 TEK 500H Screens

CODE	TOP SIZE	OVERALL SIZE	POD
FOR4XSYS 18071807	1800L	1800L x 750D x 1800L x 750D x 725H	4

SOFT WIRE KIT

All included Data Kit listed below:



1 x Quad GPO



1 x Triple DATA



1 x GPO Bracket

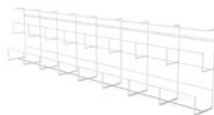

1 x 600W Basket



1 x 2.5m Interconnecting Lead



1 x Starter Socket

CODE	STYLE
PWRDKIT4	Soft Wire Kit

- Soft Wire Kit available in White Only
- Suitable for 1500 ~ 1800W Desk



VISTA - OPTIC WORKSTATIONS

Vista angle version of our linear frame with rectangle 40 x 70 mm legs and rails. Solid perimeter frame to create 2 Pods double sided workstation.

Workstation with scalloped tops included

Table Top Finish Options:
White / Colour swatches page 54 (Eo Board)
 Accessory Options: Refer to page 23

OPTIC Screen System

350H (Imported Screen)

- System Type: Solid Panel
- Screen Brackets Included
- House Fabric Colour: Charcoal

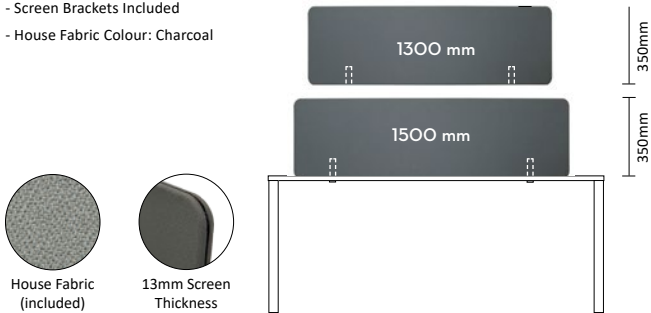

CODE	DIMENSION
ISOUTS13CH	1300W x 13D x 350H
ISOUTS15CH	1500W x 13D x 350H

600H (Local Made Screen) **New**

- System Type: Solid Panel
- Screen Brackets Included
- House Fabric Colour: Charcoal

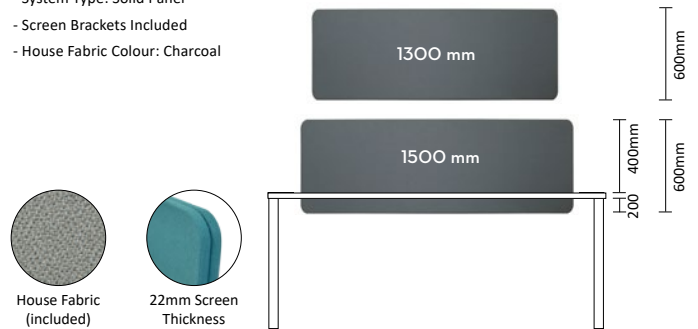

CODE	DIMENSION
ISOUTS1306	1300W x 22D x 600H
ISOUTS1506	1500W x 22D x 600H
FABRIC OPTION	Rim Trilogy 1 add +

Vista Desk



Top view



Base Finish: White / Black

CODE	OVERALL SIZE
VISDES1509	1500L x 900D x 725H
VISDES1809	1800L x 900D x 725H

Bench Single Sided x 1 pod



Top view

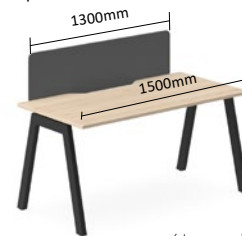

(Image shown 350H OPTIC Screen)

Base Finish: White / Black

Prices include 1 OPTIC 350H Screen

CODE	TOP SIZE	OVERALL SIZE	POD
VISBEN1509	1500L	1500L x 900D x 725H	1
VISBEN1809	1800L	1800L x 900D x 725H	1

Prices include 1 OPTIC 600H Screen

CODE	TOP SIZE	OVERALL SIZE	POD
VISBEN1509	1500L	1500L x 900D x 725H	1
VISBEN1809	1800L	1800L x 900D x 725H	1

Bench Single Sided x 2 pod

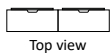

(Image shown 350H OPTIC Screen)

Base Finish: White / Black

Prices include 2 OPTIC 350H Screens

CODE	TOP SIZE	OVERALL SIZE	POD
VIS2BEN3009	1500L	3000L x 900D x 725H	2
VIS2BEN3609	1800L	3600L x 900D x 725H	2

Prices include 2 OPTIC 600H Screens

CODE	TOP SIZE	OVERALL SIZE	POD
VIS2BEN3009	1500L	3000L x 900D x 725H	2
VIS2BEN3609	1800L	3600L x 900D x 725H	2

Bench Single Sided x 3 pod

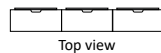

(Image shown 350H OPTIC Screen)

Base Finish: White / Black

Prices include 3 OPTIC 350H Screens

CODE	TOP SIZE	OVERALL SIZE	POD
VIS3BEN4509	1500L	4500L x 900D x 725H	3
VIS3BEN5409	1800L	5400L x 900D x 725H	3

Prices include 3 OPTIC 600H Screens

CODE	TOP SIZE	OVERALL SIZE	POD
VIS3BEN4509	1500L	4500L x 900D x 725H	3
VIS3BEN5409	1800L	5400L x 900D x 725H	3

Bench Double Sided x 2 pod



(Image shown 350H OPTIC Screen)

Base Finish: White / Black

Prices include 1 OPTIC 350H Screen

CODE	TOP SIZE	OVERALL SIZE	POD
VIS2SYS1515	1500L	1500L x 1500D x 725H	2
VIS2SYS1815	1800L	1800L x 1500D x 725H	2

Prices include 1 OPTIC 600H Screen

CODE	TOP SIZE	OVERALL SIZE	POD
VIS2SYS1515	1500L	1500L x 1500D x 725H	2
VIS2SYS1815	1800L	1800L x 1500D x 725H	2

Bench Double Sided x 4 pod

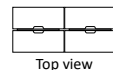

(Image shown 350H OPTIC Screen)

Base Finish: White / Black

Prices include 2 OPTIC 350H Screens

CODE	TOP SIZE	OVERALL SIZE	POD
VIS4SYS3015	1500L	3000L x 1500D x 725H	4
VIS4SYS3615	1800L	3600L x 1500D x 725H	4

Prices include 2 OPTIC 600H Screens

CODE	TOP SIZE	OVERALL SIZE	POD
VIS4SYS3015	1500L	3000L x 1500D x 725H	4
VIS4SYS3615	1800L	3600L x 1500D x 725H	4

Bench Double Sided x 6 pod

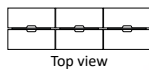

(Image shown 350H OPTIC Screen)

Base Finish: White / Black

Prices include 3 OPTIC 350H Screens

CODE	TOP SIZE	OVERALL SIZE	POD
VIS6SYS4515	1500L	4500L x 1500D x 725H	6
VIS6SYS5415	1800L	5400L x 1500D x 725H	6

Prices include 3 OPTIC 600H Screens

CODE	TOP SIZE	OVERALL SIZE	POD
VIS6SYS4515	1500L	4500L x 1500D x 725H	6
VIS6SYS5415	1800L	5400L x 1500D x 725H	6

120 Degree x 3 pod

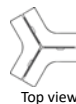

(Image shown 350H OPTIC Screen)

Base Finish: White / Black

Prices include 3 OPTIC 350H Screens

CODE	OVERALL SIZE	POD
VIS120SYS1306	1350 x 1350L x 600D x 725H	3
VIS120SYS1307	1350 x 1350L x 750D x 725H	3

Prices include 3 OPTIC 600H Screens

CODE	OVERALL SIZE	POD
VIS120SYS1306	1350 x 1350L x 600D x 725H	3
VIS120SYS1307	1350 x 1350L x 750D x 725H	3



SELECTRIC SIT / STAND

SELECTRIC RANGE

The Selectric utilises European design and technology and is constructed with a sturdy steel frame, being powered by motor drives. Maximum height is achieved via telescopic legs. The Selectric operation allows the user to easily adjust the worktop height to their individual preference. The master controller also allows the user to set the minimum and maximum heights as well making it perfect for the home or corporate office alike.

SOLO - 101 (Special Packaged Offer)

Top Finish Options: **White / Colour swatches page 54 (Eo Board)**

PART	SHAPE	CODE	DIMENSION
TOP		DSTPSB1507	1500W x 750D
		DSTPSB1807	1800W x 750D
		DSTPSBS1507	1500W x 750D
		DSTPSBS1807	1800W x 750D
		DSTPRB1507	1500W x 750D
		DSTPRB1807	1800W x 750D

PART	SHAPE	CODE	DIMENSION
OPTIC SCREEN		ISOOTS1306	1300W x 20D x 600H
		ISOOTS1506	1500W x 20D x 600H

PART	SHAPE	CODE	DIMENSION
FRAME		IMSESO101	1100 ~ 1800W x 750D x 680 ~ 1180H

OPTION	Fully Assembled (Screen, Top & Frame)
--------	---------------------------------------



Base Finish: White / Black WT BL
 Height Range included 25mm Top // 705 - 1205H



SOLO - 201

The first and still our flagship model for sit/ stand desks in Australia. It was the first Sit stand desk in Australia to have the AFRDI blue tick certificate since 2011. It has become the preferred option for the government and corporate users, It features twin motor drives for heavy duty weight offer reliability and flexibility, the 750mm deep feet give superior stability for 201.

Top Finish Options: **White / Colour swatches page 54 (Eo Board)**



CODE	DIMENSION
IMSSESO20115	1500L x 750D
IMSSESO20118	1800L x 750D
OPTION	Fully Assembled

Base Finish: White / Black WT BL
 Height Range included 25mm Top // 675 - 1325H



CORNER - 301

The Corner workstation version of the popular Solo 201. It comes as standard with 3 Motor drive/ actuators for each workstation with two Cantilever legs and one post in the corner. It is connected by adjustable beams on both sides and it has a weight rating of 150kg evenly loaded.

Top Finish Options: **White / Colour swatches page 56 (Eo Board)**

CODE	DIMENSION
IMSSECO30118	1800 x 1800W x 750D
IMSSECO30121	2100 x 2100W x 750D
OPTION	Fully Assembled

Base Finish: White / Black **WT** **BL**
 Height Range included 25mm Top // 675 - 1325H



CORNER - 120 / 301

The 120/ 301 workstation frame has a width range of 1550-2100mm on both sides and a depth range of 600-900mm making it an extremely flexible option for your 120 degree workstation choice. It is one of the strongest and most heavy duty frames of its type with a 150kg weight rating and will set the standard for others to follow in true sit/stand 120 degree workstations.

Top Finish Options: **White / Colour swatches page 54 (Eo Board)**

CODE	DIMENSION
IMSE12030112	1200 x 1200W x 750D
IMSE12030115	1350 x 1350W x 750D
OPTION	Fully Assembled

Base Finish: White / Black **WT** **BL**
 Height Range included 25mm Top // 675 - 1325H



DUO - 402

This is the new egalitarian solution for office ergonomics at a system level. Everyone has the same opportunity to enjoy and be comfortable in their own space. Pods of multiples of (2) can be created by linking frames and screens to make design and procurement simple and predictable with the level of style the modern office requires.

Top Finish Options: **White / Colour swatches page 54 (Eo Board)**

CODE	DIMENSION
IMSEDU40218	1800 x 1800W x 750D
IMSEDU40221	2100 x 2100W x 750D
OPTION	Fully Assembled

Base Finish: White **WT**
 Height Range included 25mm Top // 630 - 1290H



(1050H Optic Screen not included)

ACCESSORIES FOR WORKSTATION & SELECTRIC RANGE

CORD SNAKE (For Selectric Only)



S4 - White
S2 - Black
 - Power & Data Segregated Underdesk Cord Snake
 - 1300mm Cord Snake

CODE	DIMENSION
IMS4LKUBC (S4)	42W x 30D x 1300H
IMSECAUM (S2)	45W x 23D x 1300H

C1 FIXED CPU HOLDER



White
 Black
 - Inner Distance 128-248mm Width Adjustable
 - Inner Distance 392-552mm Height Adjustable

CODE	DIMENSION
IMC1CPU	220-275W x 23D x 440-600H

SOFT WIRE KIT (Available in White Only)

All included Data Kit listed below:

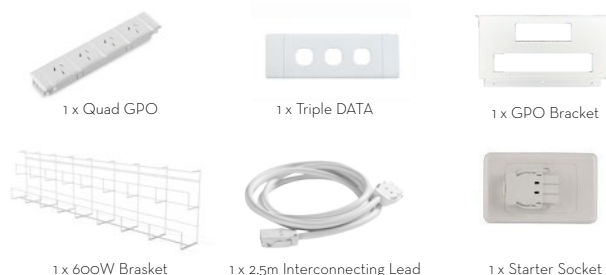

CODE	STYLE
PWRDTKIT4	Soft Wire Kit

BIONIK MONITOR ARM

New DESIGN

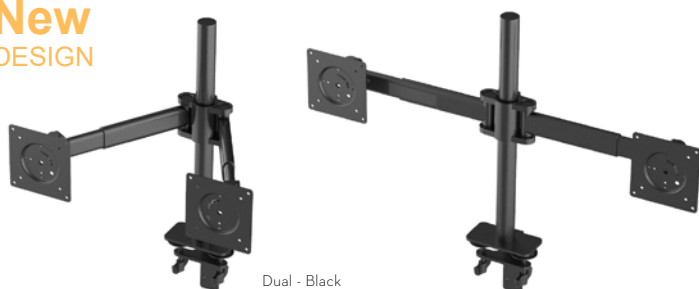

Dual - Black

- Suits Screen Size: 13" - 27" inch
- Telescopic
- Max Load: 10kg (Per Arm)
- Tilt: -15° ~ +15° degree
- Rotation: 360° degree
- Quick Release: VESA size: 75/ 100
- Clamp Clearance: 90mm (Under Desk)
- With Grommet Components (Black Satin)

*Monitor arms require scalloped tops to fit with screens

CODE	DIMENSION
IHBNSOMMBL (Solo)	400W x 100D x 400H
IHBNDUMMBL (Dual)	220 - 400W x 100D x 400H



EXECUTIVE DESKS





GEO DESK RANGE

Minimalist Design for the Contemporary office, simple yet stunning, The Geo Range is a standout design, for any executive office, customizable to fit your space and available in a choice of 45 Colours, made from Local EO board.

ENVOY DESK (Overhang Top)

Envoy desk is aesthetically pleasing yet practical as a working desk inviting for visitors with overhang feature.

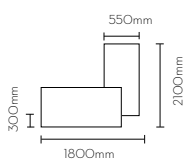

Top view



(Images shown as a left hand return)

Finish Options: **Colour swatches page 54 (EO Board)**
Rectangular Cable Hole to your preferred placement (included)

CODE	DESK	RETURN
ENVEX1805	(1800L x 900D) x (1800L x 550D) x 725H	
ENVEX2105	(2100L x 900D) x (2100L x 550D) x 725H	

GEO SLAB END DESK (Flush at the Front)

The GEO Slab End still with feature tile-lines on the return undercarriage and customizable to fit your space.

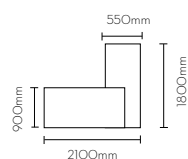

Top view

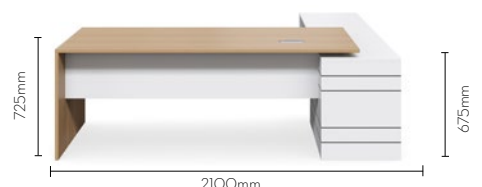

(Images shown as a left hand return)

Finish Options: **Colour swatches page 54 (EO Board)**
Cable Hole to your preferred placement (included)

CODE	DESK	RETURN
GEOSLABEX21091805	(2100L x 900D) x (1800L x 550D) x 725H	
GEOSLABEX24091805	(2400L x 900D) x (1800L x 550D) x 725H	

GEO VERSE

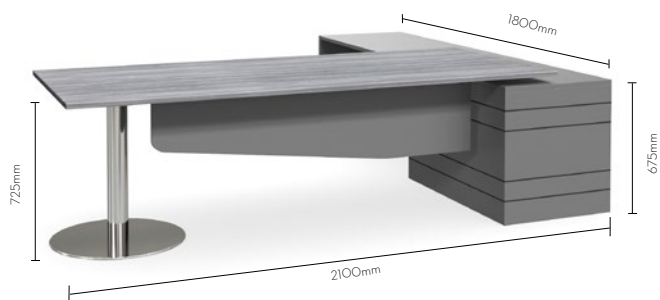

(Image shown as a left hand return)

Base Finish: Polished Stainless Steel / Black
 Finish Options: **Colour swatches page 54 (Eo Board)**
 Cable Hole to your preferred placement (included)

CODE	DESK	RETURN
GEOVEREX21092005	(2100L x 900D) x (1800L x 550D) x 725H	
GEOVEREX24092005	(2400L x 900D) x (1800L x 550D) x 725H	

GEO Desk back view

- 1 Open unit + Shelf
- Open space for Underdesk Pedestal (Add your Pedestal of Choice below)



Underdesk Mobile Pedestal Options

*Suitable for Envoy, ID Desk & GEO Range



OR



OR



Metal Pedestal
 390W x 500D x 595H
 4 Colour Options - **page 44**

1 Drawer Pedestal
 410W x 505D x 590H
 Lock Options - **page 41**
 Finish Options - **page 54**

Melamine Pedestal
 410W x 505D x 500H
 Lock Options - **page 41**
 Finish Options - **page 54**

GEO FORUM



(Image shown as a left hand return)

Base Finish: White / Black
 Finish Options: **Colour swatches page 54 (Eo Board)**
 Cable Hole to your preferred placement (included)

CODE	DESK	RETURN
GEOFRMEX21092005	(2100L x 900D) x (1800L x 550D) x 725H	
GEOFRMEX24092005	(2400L x 900D) x (1800L x 550D) x 725H	

GEO LETO



(Image shown as a left hand return)

Base Finish: White / Black
 Finish Options: **Colour swatches page 54 (Eo Board)**
 Cable Hole to your preferred placement (included)

CODE	DESK	RETURN
GEOLETOEX21092005	(2100L x 900D) x (1800L x 550D) x 725H	
GEOLETOEX24092005	(2400L x 900D) x (1800L x 550D) x 725H	

GEO VISTA



(Image shown as a left hand return)

Base Finish: White / Black
 Finish Options: **Colour swatches page 54 (Eo Board)**
 Cable Hole to your preferred placement (included)

CODE	DESK	RETURN
GEOVISEX21092005	(2100L x 900D) x (1800L x 550D) x 725H	
GEOVISEX24092005	(2400L x 900D) x (1800L x 550D) x 725H	

GEO SCOPE



(Image shown as a left hand return)

Base Finish: Black
 Finish Options: **Colour swatches page 54 (Eo Board)**
 Cable Hole to your preferred placement (included)

CODE	DESK	RETURN
GEOSCPX21092005	(2100L x 900D) x (1800L x 550D) x 725H	
GEOSCPX24092005	(2400L x 900D) x (1800L x 550D) x 725H	



GEO EXECUTIVE DESK - 101 SELECTRIC

The Geo Selectric is considered the mother ship of the Geo Series. Its new and improved design features a two level return, and signature Geo lines, making it the fully ergonomic sit/ stand desk.



HEIGHT ADJUST INCLUDED TOP // 650 - 1300H
 Price includes desk with 101 selectric frame, cable basket, 4 GPO & DATA outlets, underdesk cord snake & 3 metre lead

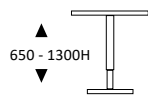

*Mobile Pedestal Options (for Empty Return Only): Refer to page 27

CODE	DESK	EMPTY RETURN
GEOSLEX20091905	(2000L x 900D) x (2100L x 550D)	
RETURN OPTION 1	Floating Drawer System add +	
RETURN OPTION 2	File & Adjustable shelves add +	

ID EXECUTIVE DESK - 101 SELECTRIC

The "ID" is as unique as you are. Designed entirely as the complete ergonomic solution, with a robust and bold aesthetic. Winner of Best Stand at Melbourne's Equinox Exhibition 2019.



Image shown with Optional Concealed Power Access Door

HEIGHT ADJUST INCLUDED TOP // 650 - 1300H
 Price includes desk with 101 selectric frame, cable basket, 4 GPO & DATA outlets, underdesk cord snake & 3 metre lead

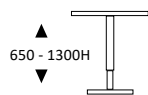

*Mobile Pedestal Options (for Empty Return Only): Refer page 27

CODE	DESK	EMPTY RETURN
IDEXE22092205	(2200L x 900D) x (2100L x 550D)	
RETURN OPTION 1	Floating Drawer System add +	
RETURN OPTION 2	File & Adjustable shelves add +	

New DESIGN

GEO Executive Desk Back view

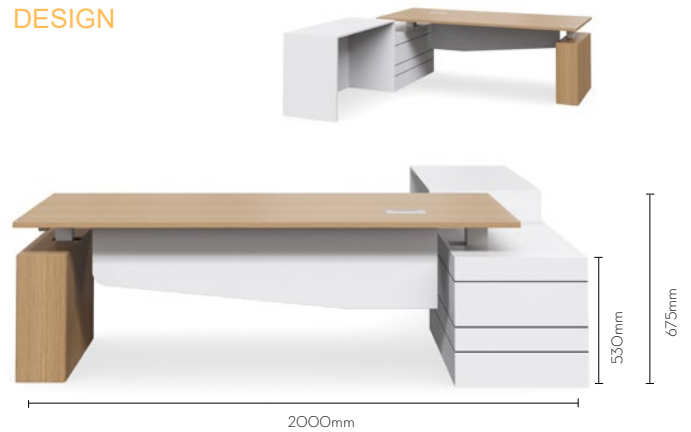

(Image shown as a left hand return)

Finish Options: Colour swatches page 54 (Eo Board)
 Rectangular Cable Hole to your preferred placement (included)

New DESIGN

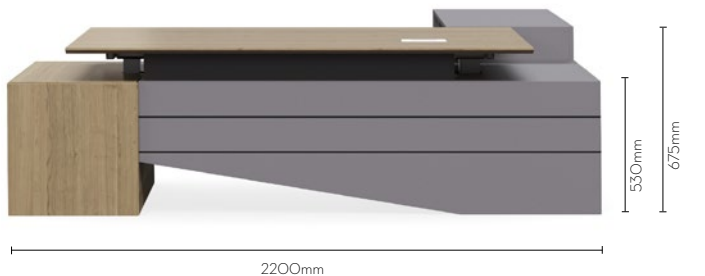

(Image shown as a left hand return)

Finish shown: Natural Walnut + Charcoal + Tile lines + Sharknosed Front Panel
 Finish Options: Colour swatches page 54 (Eo Board)
 Rectangular Cable Hole to your preferred placement (included)



DELTA NOUVEAU 120



*Accessory Options: Refer to page 23
 Base Finish: Polished Stainless Steel / Black
 Top Finish Options: Colour swatches page 54 (Eo Board)
 Rectangular Cable Hole to your preferred placement (included)

CODE	DESK	RETURN
DELWS15071506	(1500L x 750D) x (1500L x 750D) x 750H	
DELWS18071506	(1800L x 750D) x (1500L x 750D) x 750H	
OPTION	Fully Assembled 2 Melamine Modesty Panels 130H add +	

DELTA NOUVEAU



Melamine Modesty Panel

*Accessory Options: Refer to page 23
 Base Finish: Polished Stainless Steel / Black
 Top Finish Options: Colour swatches page 54 (Eo Board)
 Rectangular Cable Hole to your preferred placement (included)

CODE	DIMENSION
DNVEX1807	1800L x 750D x 750H
DNVEX2109	2100L x 900D x 750H
OPTION	Fully Assembled Melamine Modesty Panel 130H add +

OUTLINER DESK

New DESIGN



Finish Options: Colour swatches page 54 (Eo Board)

CODE	DIMENSION
OUTLNSK1809	1800L x 900D x 725H
OUTLNSK2109	2100L x 900D x 725H

OUTLINER RETURN DESK

New DESIGN



(Image shown as a left hand return)

Finish Options: Colour swatches page 54 (Eo Board)

CODE	DESK	RETURN
OUTLNRT0905	(1800L x 900D) x (900L x 550D) x 725H	
OUTLNRT1205	(2100L x 900D) x (1200L x 550D) x 725H	

LETO LITE

New DESIGN

Birdsmouth Joint
 Base Finish: White / Black
 Drawers & Storage to match
 Finish Options: Colour swatches page 54 (Eo Board)



CODE	DIMENSION
LTOLI1807	1800L x 750D x 725H
LTOLI2109	2100L x 900D x 725H

FORUM LITE

New DESIGN

Birdsmouth Joint
 Base Finish: White / Black
 Drawers & Storage to match
 Finish Options: Colour swatches page 54 (Eo Board)



CODE	DIMENSION
FORDLI1807	1800L x 750D x 725H
FORDLI2109	2100L x 900D x 725H



STORAGE EXECUTIVE RANGE

A new range of executive combinations with four different leg styles and possible buffet/return options.

Perfect for both the executive and home office alike.

Finish Options: Colour swatches page 54 (Eo Board)

2 TONE STORAGE EXECUTIVE DESK

463mm 443mm 443mm 463mm (fixed storage size)



- 1 Small Door + 2 Drawers + 1 File
- 2 Cupboards
- 1 Tall Cupboard
- Push Open System

CODE	DESK	BUFFET & STORAGE	STYLE
EXDSKC1818SC	(2100L x 900D) x (1813L x 550D) x 900H		3 Doors + 1 Storage

463mm 445mm 445mm 445mm 463mm (fixed storage size)



- 1 Small Door + 2 Drawers + 1 File
- 3 Cupboards
- 1 Tall Cupboard
- Push Open System

CODE	DESK	BUFFET & STORAGE	STYLE
EXDSKC2222SC	(2100L x 900D) x (2263L x 550D) x 900H		4 Doors + 1 Storage



Leto base shown as right hand return
(Chair not included)

TABLE LEG OPTIONS

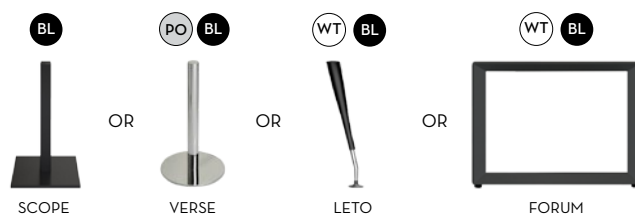

LOW STORAGE EXECUTIVE DESK

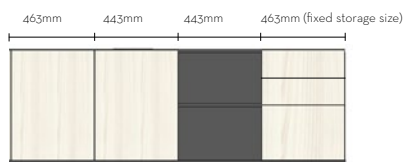

- 2 Drawers + 1 File
- 2 Cupboards
- Open Unit
- Push Open System

CODE	DESK	BUFFET & STORAGE	STYLE
EXDSKA1818SC	(1800L x 900D)	x (1813L x 550D) x 725H	2 Doors + 1 Storage



- 2 Drawers + 1 File
- 3 Cupboards
- Open Unit
- Push Open System

CODE	DESK	BUFFET & STORAGE	STYLE
EXDSKA2222SC	(2250L x 900D)	x (2263L x 550D) x 725H	3 Doors + 1 Storage

FILE STORAGE EXECUTIVE DESK

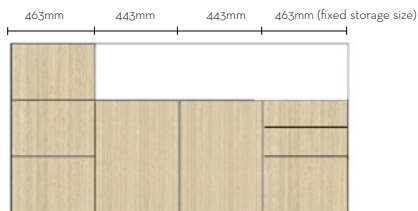

- 2 Drawers + 1 File
- 2 Cupboards
- 1 Small Door + 2 Files
- Push Open System

CODE	DESK	BUFFET & STORAGE	STYLE
EXDSKB1818SC	(2100L x 900D)	x (1813L x 550D) x 900H	2 Doors + 2 Storages

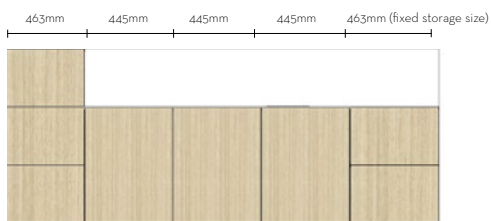

- 2 Drawers + 1 File
- 3 Cupboards
- 1 Small Door + 2 Files
- Push Open System

CODE	DESK	BUFFET & STORAGE	STYLE//
EXDSKB2222SC	(2100L x 900D)	x (2263L x 550D) x 900H	3 Doors + 2 Storages



Scope base shown as right hand return
(Chair not included)

TABLE LEG OPTIONS

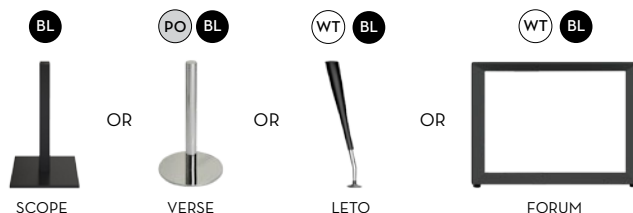

FILE STORAGE EXECUTIVE DESK



Verse base shown as right hand return
(Chair not included)

TABLE LEG OPTIONS

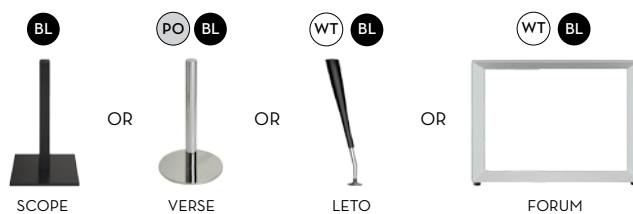



BOARDROOM TABLES





BOARDROOM

A boardroom can say a lot about a business, that's why we offer a range of boardroom tables to suit any style, combination or purpose. Our range does not stop here; we offer custom solutions as per client's requirements.

Top Finish Options: Colour swatches page 54 (EO Board)

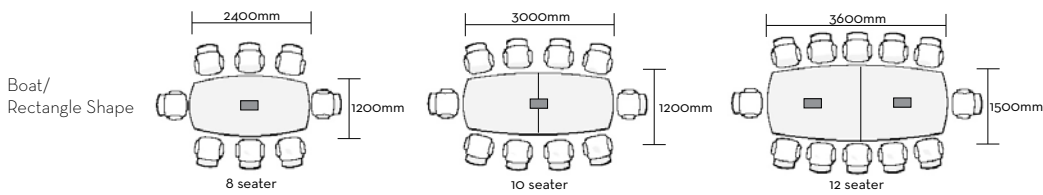

Cable Management Box with Door substitute for extra legs (applicable for 3 meter plus)
*Power Dock included

TOP SHAPES OPTIONS

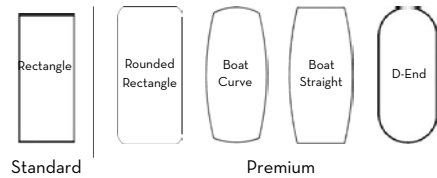

SHARK NOSE OPTION

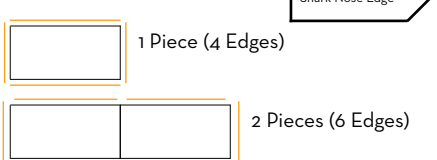

POWER DOCK OPTION



APOLLO BOARDROOM TABLE

(* Power Dock cannot be centered on Top due to extra legs)
Base Finish: Chrome
(25mm Rectangle Top Shown)

CODE	DIMENSION	LEG
IMAPBTB2412	2400L x 1200D x 750H	4
IMAPBTB3012	3600L x 1200D x 750H (*)	6
IMAPBTB3615	3600L x 1500D x 750H (*)	6
OPTION	Fully Assembled	4
		6



VISTA BOARDROOM TABLE

(* Power Dock cannot be centered on Top due to extra legs)
Works well with Flush Top
Base Finish: White / Black
(25mm Rectangle Top Shown)

CODE	DIMENSION	LEG
VISBRDBL2109	2100L x 900D x 725H	4
VISBRDBL2412	2400L x 1200D x 725H	4
VISBRDBL3012	3000L x 1200D x 725H (*)	6
VISBRDBL3615	3600L x 1500D x 725H (*)	6
OPTION	Fully Assembled	4
		6

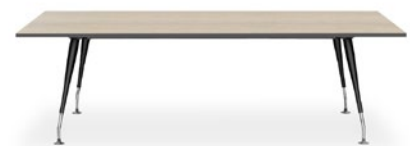

LETO BOARDROOM TABLE

Frame Height: 725 - 825 (H)
Base Finish: White / Black
(25mm Rectangle Top Shown)

CODE	DIMENSION	LEG
LEBRDTB2109	2100L x 900D	4
LEBRDTB2412	2400L x 1200D	4
LEBRDTB3012	3000L x 1200D	4
OPTION	Fully Assembled	4

New DESIGN

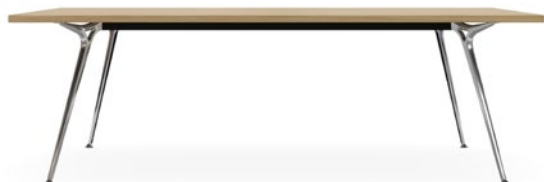

KATO BOARDROOM TABLE

(* Power Dock cannot be centered on Top due to extra legs

Base Finish: Chrome

(25mm Rectangle Top Shown)

CODE	DIMENSION	LEG
KTBRDTB2109	2100L x 900D x 750H	4
KTBRDTB2412	2400L x 1200D x 750H	4
KTBRDTB3012	3000L x 1200D x 750H	4
KTBRDTB3615	3600L x 1500D x 750H (*)	6
OPTION	Fully Assembled	4
		6

New DESIGN

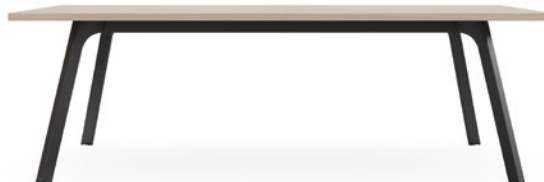

TORO BOARDROOM TABLE (Works well with Overhang Top)

(* Power Dock cannot be centered on Top due to extra legs

Base Finish: Black

(25mm Rectangle Top Shown)

CODE	DIMENSION	LEG
TOBRDTB2109	2100L x 900D x 750H	4
TOBRDTB2412	2400L x 1200D x 750H	4
TOBRDTB3012	3000L x 1200D x 750H	4
TOBRDTB3615	3600L x 1500D x 750H (*)	6
OPTION	Fully Assembled	4
		6

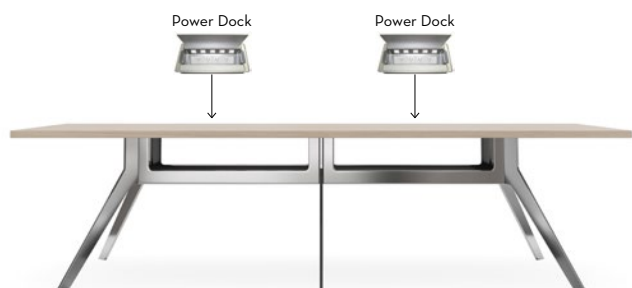

Duo Frame



Solo Frame suits Top from 750 to 1300D

Duo Frame suits Top from 1400 to 1800D

DELTA NOUVEAU BOARDROOM TABLE

(* Power Dock cannot be centered on Top due to extra legs

Base Finish: Polished Stainless Steel / Black

(25mm Rectangle Top Shown)

CODE	DIMENSION	LEG
IMDND2B3615 (Duo)	3600L x 1500D x 750H (*)	6
IMDND2B3618 (Duo)	3600L x 1800D x 750H (*)	6
IMDND2B4218 (Duo)	4200L x 1800D x 750H (*)	6
OPTION	Fully Assembled (Recommend)	



SUPREME BOARDROOM TABLE

Base Finish: Polished Stainless Steel

(25mm Boat Straight Top Shown)

CODE	DIMENSION	LEG
IMSU1BA2109	2100L x 900D x 725H	2
IMSU1BA2412	2400L x 1200D x 725H	2
IMSU1BA2712	2700L x 1200D x 725H	2
IMSU1BA3012	3000L x 1200D x 725H	2
OPTION	Fully Assembled	

DELTA NOUVEAU BOARDROOM TABLE

(* Power Dock cannot be centered on Top due to extra legs

Base Finish: Polished Stainless Steel / Black

(25mm Rectangle Top Shown)

CODE	DIMENSION	LEG
IMDND2B2109 (Solo)	2100L x 900D x 750H	4
IMDND2B2412 (Solo)	2400L x 1200D x 750H	4
IMDND2B2712 (Solo)	2700L x 1200D x 750H	4
IMDND2B3012 (Solo)	3000L x 1200D x 750H (*)	6
OPTION	Fully Assembled (Recommend)	4
		6



SCOPE BOARDROOM TABLE

(* Power Dock cannot be centered on Top due to extra legs

18mm Platter included

Base Finish: Black

(25mm Rectangle Top Shown)

CODE	DIMENSION	LEG
DISBRDTBL2412	2400L x 1200D x 745H	2
DISBRDTBL3015	3000L x 1200D x 745H (*)	3
DISBRDTBL3615	3600L x 1200D x 745H (*)	3
OPTION	Fully Assembled	2
		3



TRAINING / MEETING TABLE

We offer you elegant functional frames in all sizes and styles in meeting and training tables. We will have the right solution for your needs. Remember training rooms need elbow room as well as space to move around the room with ease.

Top Finish Options: Colour swatches page 54 (EO Board)



HIGHBENCH CUSTOM TABLE

Base Finish: White / Black
Custom dimension available on request



CODE	DIMENSION
TM2107510WT	2100W x 750D x 1000H
OPTION	Castor Sets of 4



FOCUS HIGHBENCH

25mm Board - Slab End
50mm Board - Slab End (Natural Oak Only)
Wooden Stools

Height: From 930 to 1000H depends on Stools

New
DESIGN

CODE	DIMENSION
FOHB150610	1500W x 600D
FOHB180710	1800W x 750D
FOHB210710	2100W x 750D



SCOPE HIGHBENCH

Base Finish: Black

CODE	DIMENSION
IMSCHB1875	1800W x 750D x 1025H
IMSCHB2175	2100W x 750D x 1025H
OPTION	Fully Assembled



5 WAY HEAVY DUTY MEETING TABLE

Base Finish: Black / White / Silver / Graphite Ripple

CODE	DIMENSION
TB5WHD15	Ø1500 x 725H
TB5WHD18	Ø1800 x 725H
OPTION	Chrome Base Finish add +



SUPREME MEETING TABLE

Base Finish: White / Black / Chrome

CODE	DIMENSION
IMSMTBA9	Ø900 x 725H
IMSMTBA12	Ø1200 x 725H
OPTION	Fully Assembled



STAR MEETING TABLE

Base Finish: Brushed Stainless Steel

CODE	DIMENSION
IMSTMTBA9	Ø900 x 725H
IMDEMNTBA12	Ø1200 x 725H
OPTION	Fully Assembled

TOP SHAPES OPTIONS

Top Finish Options: Colour swatches page 54 (Eo Board)

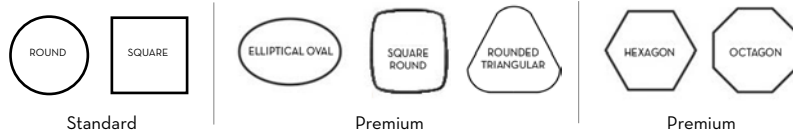

TOP PROFILE OPTIONS

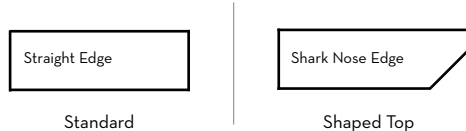

KATO MEETING TABLE

New DESIGN

Base Finish: Chrome

CODE	DIMENSION
KTMTTB09	∅900 x 750H
KTMTTB12	∅1200 x 750H
OPTION	Fully Assembled



TORO MEETING TABLE

New DESIGN

Base Finish: Black

CODE	DIMENSION
TOMTTB12	∅1000 - 1200 x 750H
OPTION	Fully Assembled



HOST FLIP TABLE



Base Finish: Black + Satin

Top Finish: White / Colour swatches page 54 (Eo Board)

CODE	DIMENSION
IMHOFTB15	1500L x 750D x 725H
IMHOFTB18	1800L x 750D x 725H
OPTION	2 Sets Connector Fully Assembled or Pre-drilled



LETO MEETING TABLE

Base Finish: White / Black

CODE	DIMENSION
IMLEMT9	∅900 x 725 - 825H
IMLEMT12	∅1200 x 725 - 825H
OPTION	Fully Assembled



DELTA NOUVEAU MEETING TABLE - 3 LEGS

Base Finish: Polished Stainless Steel / Black

CODE	DIMENSION
IMDEMTBA7	∅750 x 750H
IMDEMTBA9	∅900 x 750H
OPTION	Fully Assembled



DELTA NOUVEAU MEETING TABLE - 4 LEGS

Base Finish: Polished Stainless Steel / Black

CODE	DIMENSION
IMDESQMT	900W x 900D x 750H
IMDEMTBA12	∅1200 x 750H
OPTION	Fully Assembled



APOLLO MEETING TABLE

Base Finish: Chrome

CODE	DIMENSION
IMAPMTB9	∅900 x 750H
IMAPMTB12	∅1200 x 750H
IMAPMTB15	∅1500 x 750H
IMAPMTB18	∅1800 x 750H
OPTION	Fully Assembled



SCOPE MEETING / BAR TABLE

Base Finish: Black

CODE	DIMENSION
IMSCMTBA7	750W x 750D x 725H
IMSCMTBA9	900W x 900D x 725H
IMSCBABA7	750W x 750D x 1025H
IMSCBABA9	900W x 900D x 1025H
OPTION	Fully Assembled



VERSE MEETING / BAR TABLE

Base Finish: Brushed Stainless Steel / Black

CODE	DIMENSION
IMVSBABA9	∅900 x 725H
IMVSBABA12	∅1200 x 725H
IMVSBABA7	∅750 x 1025H
IMVSSQBA7	700W x 700D x 1025H
OPTION	Fully Assembled



New



EDUCATION

EDUCATION SPACE

The Education Space is forever evolving and changing the way we work, learn and move, so we are growing our range to meet some of your needs when it comes to classrooms, libraries and collaborative areas.

LOCKERS

300W x 500D x 1800H

*Refer to page 42 for more details

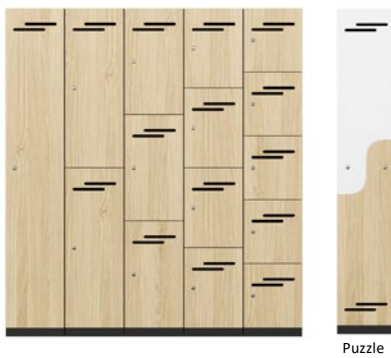

Finish Options: Colour swatches page 54 (Eo Board)

CODE	STYLE	CODE	STYLE
LOCK01	1 Doors	LOCK04	4 Doors
LOCK02	2 Doors	LOCK05	5 Doors
LOCK03	3 Doors	PUZLOCK	6 Doors

MOBILE MULTIMEDIA UNIT

New DESIGN



Finish Options: Colour swatches page 54 (Eo Board)

CODE	DIMENSION
ICBOS	1200W x 830D x 1600H



MOBILE TOTE BOX METAL TROLLEY

- 18mm Melamine Top (Available in Grey Only)
- 25 x 25mm Graphite Ripple Steel tube frame
- Plastic storage boxes
- Heavy duty lockable PU swivel castors

CODE	DIMENSION	TUB
TBTR05	540W x 420D x 873H	5
TBTR10	992W x 420D x 873H	10
TBTR15	1450W x 420D x 873H	15



MOBILE TOTE BOX MELAMINE TROLLEY

- 18mm Melamine Carcass
 - Plastic storage boxes
 - Heavy duty lockable PU swivel castors
- Melamine Finish Options: Grey / Colour swatches page 54 (Eo Board)

CODE	DIMENSION	TUB
TBMTR05	415W x 454D x 886H	5
TBMTR10	810W x 454D x 886H	10
TBMTR15	1203W x 454D x 886H	15

KONNECT



* Fully Assembled

Corner L/ R

Middle

Ottoman

CODE	DIMENSION
ICKOLBDG	750W x 750D x 710H (Corner L/R)
ICKOSBDG	550W x 750D x 710H (Middle)
ICKOOTDG	550W x 750D x 710H (Ottoman)

BOON LOUNGE



* Fully Assembled

CODE	DIMENSION
ICBOSMG	1600W x 800D x 1200H

HOST FLIP TABLE



Base Finish: Black + Satin

Top Finish Options: White / Colour swatches page 54 (Eo Board)

CODE	DIMENSION
IMHOFTB15	1500L x 750D x 725H
IMHOFTB18	1800L x 750D x 725H
OPTION	2 Sets Connector Fully Assembled or Pre-drilled

VOLT FLIP TABLE



Base Finish: Black + Silver Pearls

Top Finish Options: Colour swatches page 54 (Eo Board)

CODE	DIMENSION
IMVOFLBA7	∅700 x 725H
IMVOFLBA8	∅800 x 725H
IMVOFLBA9	∅900 x 725H
OPTION	Fully Assembled

T-LEG STUDENT DESK



18mm Grey Top (round corners)
Charcoal plastic storage tub
7 levels tech height adjustable (560 - 800h)
Anti - scratch zinc-coated bottom foot
Anti - scratch coating Graphite Ripple frame

Top Finish Options: Colour swatches page 54 (Eo Board)

CODE	DIMENSION	TUB
SDHA0606	600W x 600D	1
SDHA1206	1200W x 600D	1
OPTION	Fully Assembled	

QUAD TABLE



18mm Melamine Top
25x25mm Steel Grey tube frame
Adjustable Plastic Feet

Top Finish Options: Grey / Colour swatches page 54 (Eo Board)

CODE	DIMENSION
QUTA0606GR	600L x 600D x 718H
QUTA1206GR	1200L x 600D x 718H
QUTA1507GR	1500L x 750D x 718H
QUTA1809GR	1800L x 900D x 718H
OPTION	Fully Assembled

CELL TABLE



18mm Melamine Top
25x25mm Steel Black tube frame

Top Finish Options: Colour swatches page 54 (Eo Board)

CODE	DIMENSION
CETA0907	∅900 x 725H

TRI TABLE



18mm Melamine Top
25x25mm Steel Black tube frame

Top Finish Options: Colour swatches page 54 (Eo Board)

CODE	DIMENSION
TRTA080607	783W x 550D x 725H

BOOKCASE

Finish Options: Colour swatches page 54 (Eo Board)



CODE	DIMENSION	SHELVES
BXBC900	900W 450D x 900H	2
BXBC1200	900W 450D x 1200H	2
BXBC1500	900W 450D x 1500H	3
BXBC1800	900W 450D x 1800H	4

PIGEON HOLE

27 Holes x 18mm Adjustable Shelves
Finish Options: Colour swatches page 54 (Eo Board)



CODE	DIMENSION
CLPHBC	900W x 330D x 1800H

KONNECT BOX

Finish Options: Colour swatches page 54 (Eo Board)



Pop - Up Index:
- 1 x Auto switch GPO
- 2 x USB Charger

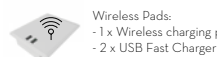

Wireless Pads:
- 1 x Wireless charging pad
- 2 x USB Fast Charger

CODE	DIMENSION
KONBOX	300W x 750D x 380H
KONBOXPU	Connect Box + Pop-Up
KONBOXWI	Connect Box + Wi Pad

BOOK RETURN TROLLEY



18mm Melamine
Depressible Plat
Heavy duty lockable PU swivel castors

Finish Options: Colour swatches page 54 (Eo Board)

CODE	DIMENSION
BOODT	600W x 600D x 600H

MOBILE MAGAZINE RACK



Perspex Fascias
18mm Melamine + Acrylic Perspex
Heavy duty lockable PU swivel castors

Finish Options: Colour swatches page 54 (Eo Board)

CODE	DIMENSION
MOBMR12	1200W x 400D x 980H
MOBMR18	1800W x 400D x 980H



STORAGE

Melamine Finish Options: Colour swatches page 54 (Eo Board)



MOBILE PEDESTAL
410W x 505D x 650H

CODE	STYLE
BXMP4	4 Drawers
BXMP3	2 + 1 File Drawers



MOBILE PEDESTAL + OPEN UNIT
900W x 450D x 650H

CODE	STYLE
BXMP4OU	Open Unit + 4 Drawers
BXMP3OU	Open Unit + (2 + 1 File Drawers)



MOBILE PEDESTAL + CUPBOARD
1200W x 450D x 650H

CODE	STYLE
BXMP4CP	2 Doors + 4 Drawers
BXMP3CP	2 Doors + (2 + 1 File Drawers)



FILING CABINET
4 File Drawers Rank

CODE	DIMENSION
BX2LATCP	900W x 600D x 725H

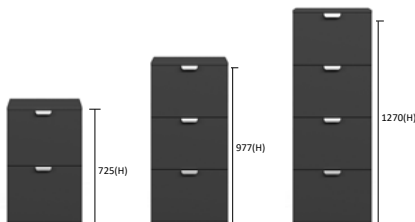

FILING CABINET
File Drawers

CODE	DIMENSION	DRAWERS
BX2FL	465W x 505D x 725H	2
BX3FL	465W x 505D x 977H	3
BX4FL	465W x 505D x 1270H	4



BOOKCASES
Adjustable Shelves

CODE	DIMENSION	SHELVES
BXBC900	900W 450D x 900H	2
BXBC1200	900W 450D x 1200H	2
BXBC1500	900W 450D x 1500H	3
BXBC1800	900W 450D x 1800H	4



TALL CUPBOARD
900W x 450D x 1800H

CODE	STYLE
CLCPBC18	Half Doors + 3 Shelves
CLCP418	4 Doors + 4 Shelves
CLCP218	2 Doors + 4 Shelves



ROUND LIBRARY BOOKCASE

CODE	DIMENSION
CLBRND9075	Ø900 x 750H
CLBRND1275	Ø1200 x 750H



UNDERDESK PEDESTAL
Suitable for Envoy & Geo Return

CODE	DIMENSION
BXMP10U	410W x 505D x 590H
MP1D1F	410W x 505D x 500H

*Lock Options - page 41



SLIDING DOOR CREDENZA
Sliding Doors with Handles / Adjustable Feet

CODE	DIMENSION	DOORS
BXCPSL900	900W x 450D x 725H	2
BXCPSL1500	1500W x 450D x 725H	2
BXCPSL1800	1800W x 450D x 725H	2



CUPBOARD DOOR CREDENZA
Double Doors with Handles / Soft Closing Doors / Adjustable Feet

CODE	DIMENSION	DOORS
BXCPH900	900W x 450D x 725H	2
BXCPH1500	1500W x 450D x 725H	2
BXCPH1800	1800W x 450D x 725H	4
BXCPH2100	2100W x 450D x 725H	4



CREDENZA - A
Push Open System / Adjustable Feet

CODE	DIMENSION	DOORS
RECCREA1804	1800W x 450D x 900H	4
RECCREA2104	2100W x 450D x 900H	4
RECCREA2404	2400W x 450D x 900H	6



CREDENZA - B
Floating top / Push Open System / Adjustable Feet

CODE	DIMENSION	DOORS
RECCREB1804	1800W x 450D x 900H	4
RECCREB2104	2100W x 450D x 900H	4
RECCREB2404	2400W x 450D x 900H	6



CREDENZA - C
Doors + Open unit / Push Open System

CODE	DIMENSION	DOORS
RECCREC1804	1800W x 450D x 900H	4
RECCREC2104	2100W x 450D x 900H	4
RECCREC2404	2400W x 450D x 900H	6



CREDENZA - D
2 Tone +Title-line Finish / Soft Closing Doors / Black or White Tubular Steel Feet

CODE	DIMENSION	DOORS
RECCRED1804	1800W x 450D x 900H	4
RECCRED2104	2100W x 450D x 900H	4
RECCRED2404	2400W x 450D x 900H	6



CREDENZA - E
Overlay Doors / 2 Tone Finish / Soft Closing Doors / Adjustable Feet

CODE	DIMENSION	DOORS
RECCREE1804	1800W x 450D x 900H	4
RECCREE2104	2100W x 450D x 900H	4
RECCREE2404	2400W x 450D x 900H	6



CREDENZA - F
2 Tier construction / 2 Tone Finish / Soft Closing Doors / Adjustable Feet

CODE	DIMENSION	DOORS
RECCREF1804	1800W x 450D x 900H	4
RECCREF2104	2100W x 450D x 900H	4
RECCREF2404	2400W x 450D x 900H	6



CREDENZA - H
Birdsmouth Joints / Finger Pull & Soft Closing Doors / Black or White Tubular Steel Feet

CODE	DIMENSION	DOORS
RECCREH1504	1500W x 450D x 900H	4
RECCREH1804	1800W x 450D x 900H	4
RECCREH2104	2100W x 450D x 900H	4
RECCREH2404	2400W x 450D x 900H	6

**New
DESIGN**



MELAMINE PLANTER UNIT
2 Soft Closing Doors + 1 Open Space

CODE	DIMENSION
MEPL090509	900W x 450D x 1335H
OPTION	3 Plants + Pebbles or Barks



PLANTER BOX
18mm Melamine Structure

CODE	DIMENSION
PLB9	900W x 450D x 240H
OPTION	3 Plants + Pebbles or Barks

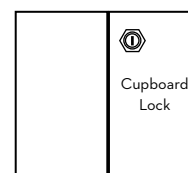
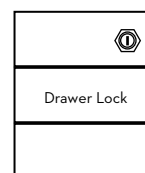

LOCK OPTIONS

CODE	STYLE	DOORS
DRALOCK	Drawer Lock	2
CUPLOCK	Cupboard Lock	2
CREDENZA H	4 Doors Additional +	4
	6 Doors Additional +	4



LOCKERS

STANDARD LOCKER DIMENSION

300W x 500D x 1800H

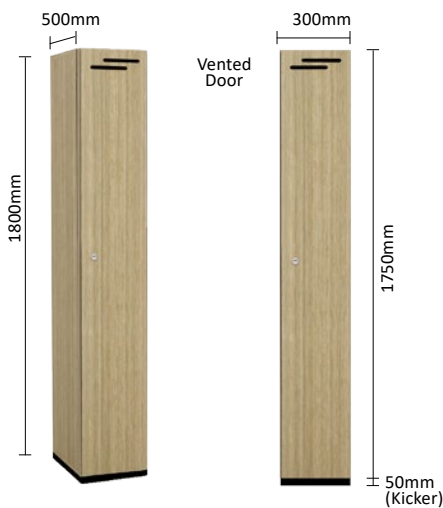

TYPES OF LOCKS



Cupboard Lock
Included



Latch for Padlock

LOCKER SPECS (Important info)

All lockers are priced as 1 Unit, 2 Unit & 3 Unit combos only. Maximum 3 Units due to weight restrictions

Internal Carcass Finish Options (included):

- 18mm Melamine White or Black Only (WT) (BL)

Internal Carcass Custom Finish Options (additional):

- Colour swatch page 54 (E0 Board)

Doors Finish Options:

- Colour swatch page 54 (E0 Board)

Kicker:

- Available in Black only (BL)

From wall to wall:

- Finish of End Side Panels: White or Black (WT) (BL)

Free Standing:

- Finish of End Side Panels: Match the Door Colour (additional)

1 DOOR LOCKERS

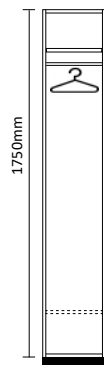

Internal Locker:
- 1 Fixed Shelf
- 1 Hanging Rail

Option:
- Adjustable Shelf

2 DOOR LOCKERS

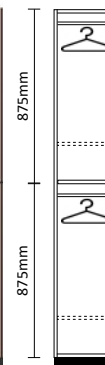

Internal Locker
- 1 Hanging Rail

Option:
- Adjustable Shelf

Option:
- Adjustable Shelf

CODE	QUANTITY
LOCK01	1 Locker
	2 Lockers
	3 Lockers

CODE	QUANTITY
LOCK02	1 Locker
	2 Lockers
	3 Lockers

3 DOOR LOCKERS

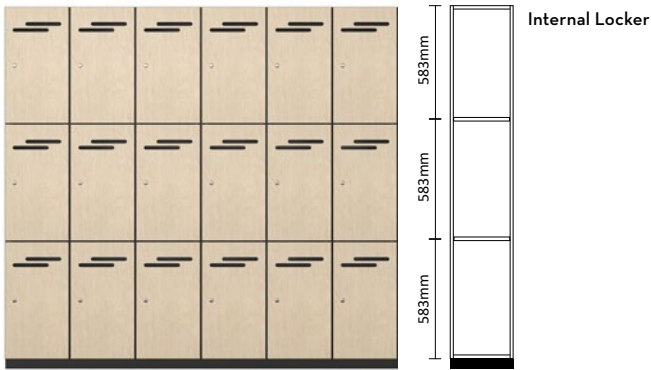

CODE	QUANTITY
	1 Locker
LOCK03	2 Lockers
	3 Lockers

4 DOOR LOCKERS

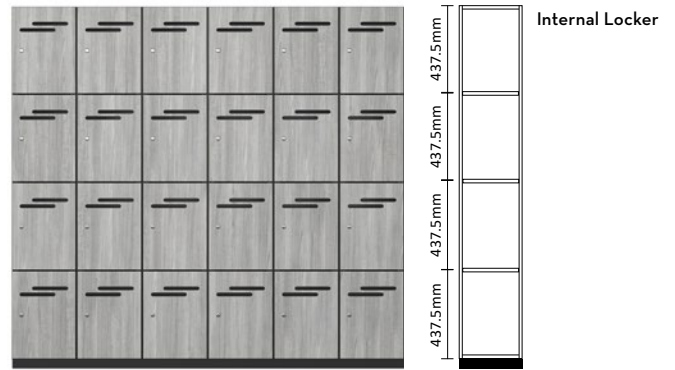

CODE	QUANTITY
	1 Locker
LOCK04	2 Lockers
	3 Lockers

5 DOOR LOCKERS

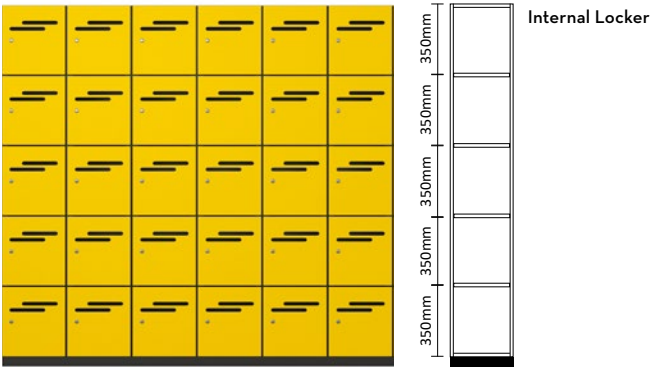

CODE	QUANTITY
	1 Locker
LOCK05	2 Lockers
	3 Lockers

PUZZLE DOOR LOCKERS

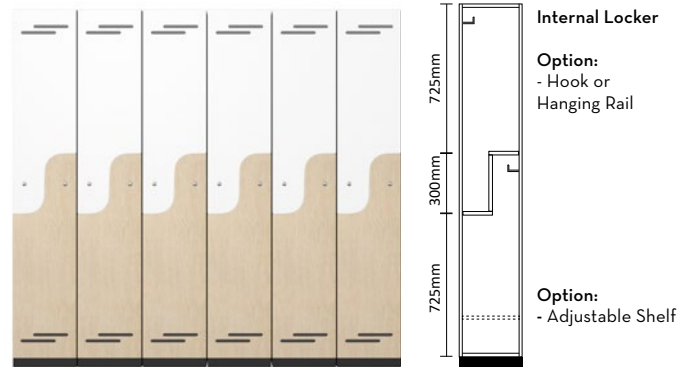

CODE	QUANTITY
	1 Locker
PUZLOCK	2 Lockers
	3 Lockers

BLACK GARDEN LOCKERS (Metal & Melamine Design)

New DESIGN



(2 Bases of 1200W shown - Plant B included)

CODE	DIMENSION
GDLK120518BL	1200W x 500D x 1900H
Each Locker Size	300W x 500D x 600H

*Refer to page 53 for more details

WHITE GARDEN LOCKERS (Metal & Melamine Design)

New DESIGN



(2 Bases of 1200W shown - Plant B included)

CODE	DIMENSION
GDLK120518WT	1200W x 500D x 1900H
Each Locker Size	300W x 500D x 600H

*Refer to page 53 for more details



METAL STORAGE

The Lunar metal storage options offer quick and easy storage solutions. Use our versatile mobile pedestal or tambour door cupboards to help keep supplies neat and accessible. Matching planter boxes are available to sit on the tambour door unit, bring the workplace to life with plants integrated into your office space. Whatever your choice is, you've come to the right place for storage cabinets.



LUNAR METAL MOBILE PEDESTALS



White



Silver Pearl



Charcoal



Black

- Lockable 2 Drawers + File Drawer
- Pencil Tray Included
- Adjustable Divider in Top Drawer
- Fully Assembled

CODE	DIMENSION
IMLUMP3L	390W x 500D x 595H

LUNAR METAL MOBILE CADDY

- Lockable 2 Drawers + File Drawer
- Pencil Tray Included
- Adjustable Divider in Top Drawer
- Fully Assembled



Right Hand Door



Left Hand Door

CODE	DIMENSION
IMLUCAMP	900W x 500D x 595H

1 DRAWER + FILE MOBILE PEDESTAL

- Lockable 1 Drawer + File Drawer
- Pencil Tray Included
- Adjustable Divider in Top Drawer
- Suitable for sit/stand Desks
- Fully Assembled



CODE	DIMENSION
IMLUMP2LWT	390W x 500D x 495H

LUNAR WHITE METAL COMBINATION - 750W

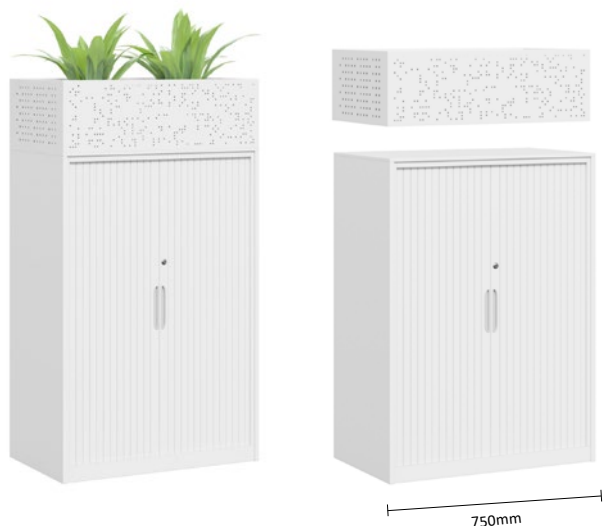

PLANTER BOX

- 2 Holes for 2 Plants
- Fully Assembled



CODE	DIMENSION
IMLUPB07WT	750W x 450D x 240H (Planter Box)
OPTION	2 Dracaena Plants + Pebbles or Barks
Dracaena Plant	550W x 550D x 600H

TAMBOUR DOOR CABINET

- Fully Assembled

CODE	DIMENSION
IMLUTDC3T07WT	750W x 450D x 1095H

LUNAR WHITE METAL COMBINATION - 900W



PLANTER BOX

- 3 Holes for 3 Plants
- Fully Assembled



CODE	DIMENSION
IMLUPB09WT	900W x 450D x 240H (Planter Box)
OPTION	3 Dracaena Plants + Pebbles or Barks
Dracaena Plant	550W x 550D x 600H

TAMBOUR DOOR CABINET

- Fully Assembled

CODE	DIMENSION
IMLUTDC3T09WT	900W x 450D x 1095H

LUNAR BLACK METAL COMBINATION - 900W



PLANTER BOX

- 3 Holes for 3 Plants
- Fully Assembled

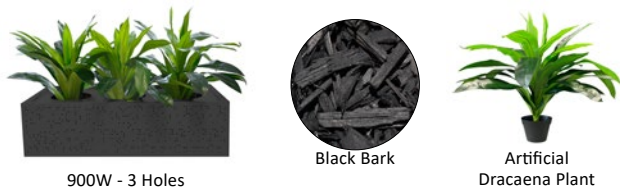

CODE	DIMENSION
IMLUPB09BL	900W x 450D x 240H (Planter Box)
OPTION	3 Dracaena Plants + Pebbles or Barks
Dracaena Plant	550W x 550D x 600H

TAMBOUR DOOR CABINET

- Fully Assembled

CODE	DIMENSION
IMLUTDC3T09BL	900W x 450D x 1095H



SOFT SEATING

Soft seating and breakout chairs are becoming more and more important in any breakout area as visitor chairs and sofas can create comforting warm and welcoming environment to any organization. **Fully assembled for all seating.**



SG DG
Limited Edition



SG DG
Limited Edition



SG DG
Limited Edition

KONNECT CORNER

Code: ICKOLBDG

Seat Height: 420(H)

750(W) x 750(D) x 710(H)

Material:

Seat & Back - Grey / Silver Grey Fabric Upholstered

Base - Steel Chrome Finish



KONNECT MIDDLE

Code: ICKOSBDG

Seat Height: 420(H)

550(W) x 750(D) x 710(H)

Material:

Seat & Back - Grey / Silver Grey Fabric Upholstered

Base - Steel Chrome Finish



KONNECT OTTOMAN

Code: ICKOOTDG

Seat Height: 420(H)

550(W) x 750(D) x 420(H)

Material:

Seat & Back - Grey / Silver Grey Fabric Upholstered

Base - Steel Chrome Finish



CONFIGURATION - A

Konnect Corner: x 2



KONNECT BOX (Refer to page 11)

- Designed with Slim Line Lap Joints

CODE	DIMENSION
KONBOX	300W x 750D x 380H



CONFIGURATION - B

Konnect Corner: x 4

Konnect Ottoman: x 4

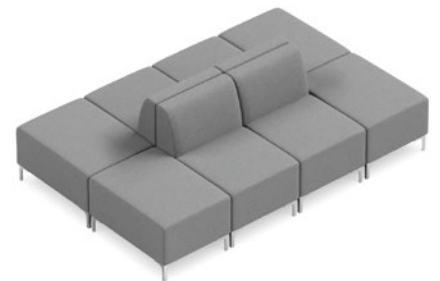

CONFIGURATION - C

Konnect Middle: x 4

Konnect Ottoman: x 4

**EADU ARM CHAIR**

Code: ICEDAR
 Seat Height: 390(H)
 690(W) x 780(D) x 830(H)
 Material:
 Seat & Back - Fabric Upholstered
 Base - Black Powder-coated Steel

**BOON LOUNGE**

Code: ICBOSMG
 Seat Height: 410(H)
 1600(W) x 800(D) x 1200(H)
 Material:
 Seat & Back - Mid Grey Fabric Upholstered
 Base - Polished Stainless Steel

New
 DESIGN

**LOLA LOUNGE**

Code: ICLO1SLGN
 Seat Height: 390(H)
 760(W) x 650(D) x 760(H)
 Material:
 Seat & Back - Green Fabric Upholstered
 Base - Black Aluminium Finish

New
 DESIGN

**NOOR - LOW BACK**

Code: ICNOLBGR
 Seat Height: 410(H)
 1500(W) x 750(D) x 800(H)
 Material:
 Seat - Grey Fabric Upholstered
 Back - Grey Fabric Upholstered
 Base - Steel Black Finish

New
 DESIGN

**NOOR - HIGH BACK**

Code: ICNOHBGR
 Seat Height: 410(H)
 1500(W) x 750(D) x 1250(H)
 Material:
 Seat - Grey Fabric Upholstered
 Back - Grey Fabric Upholstered
 Base - Steel Black Finish

**KAMINO 1 SEATER**

Code: ICKM1SGRGR
 Seat Height: 440(H)
 880(W) x 610(D) x 760(H)
 Material:
 Seat - Grey Fabric Upholstered
 Back - Dark Grey PU
 Base - Steel Chrome Finish

**KAMINO 2 SEATER**

Code: ICKM2SGRGR
 Seat Height: 440(H)
 1380(W) x 610(D) x 760(H)
 Material:
 Seat - Grey Fabric Upholstered
 Back - Dark Grey PU
 Base - Steel Chrome Finish



Sled



Castors

DG

MOZZIE

Code: ICMOMECH
 Seat Height: 450(H)
 450(W) x 465(D) x 820(H)
 Material:
 Seat & Back - Dark Grey Fabric Upholstered
 Base - Steel Powder Coated Black / PU Castors



**New
DESIGN**



DG

YOYO TUB CHAIR

Code: ICYOCTMTCH
 Seat Height: 460 - 560(H)
 630(W) x 555(D) x 810-910(H)
 Material:
 Seat & Back - Dark Grey Fabric Upholstered
 Base - Black Aluminium 5 Way Base

**New
DESIGN**



CH

MOZZIE BAR STOOL

Code: ICMOBSCH
 Seat Height: 760(H)
 480(W) x 490(D) x 1010(H)
 Material:
 Seat & Back - Charcoal Fabric Upholstered
 Base - Steel Powder Coated Black



WT

BL



Embossed
Pattern

EMBOSS BAR STOOL

Code: ICEMBSBL
 Seat Height: 760(H)
 515(W) x 495(D) x 945(H)
 Material:
 Seat & Back - UV Protected Plastic
 Base - Steel Powder Coated Black / Chrome Finish
 *Interchangeable Base & Seat



High Back



Mid Back

TURIN GROUP

Code: ICTUGR
 Seat Height: 440 - 525(H)
 High Back: 580(W) x 630(D) x 1075 - 1150(H)
 Mid Back: 580(W) x 630(D) x 880 - 960(H)
 Material:
 Seat - Synthetic Leather
 Base - Polished Aluminium 5 Way Base



BERKELEY

Code: ICBEMBLE
 Seat Height: 440 - 540(H)
 580(W) x 630(D) x 880 - 960(H)
 Material:
 Seat - Genuine Leather
 Base - Chromed Aluminium 5 Way Base





GR



OR

BL

MAKO

Code: ICMATRSCBL
 Seat Height: 450(H)
 460(W) x 510(D) x 845(H)
 Material:
 Seat - Grey Fabric Upholstered
 Back - UV Protected Plastic
 Base - Steel Powder Coated Black



BONN

Code: ICBOVI
 Seat Height: 450(H)
 550(W) x 500(D) x 850(H)
 Material:
 Seat - Fabric Upholstered
 Back - Mesh
 Base - Steel Chrome Finish



Embossed Pattern

Sled

Castors

BL



Embossed Pattern

WT

EMBOSS CHAIR - BLACK

Code: ICEMVSBL
 Seat Height: 450(H)
 550(W) x 500(D) x 830(H)
 Material:
 Seat & Back - UV Protected Plastic
 Base - Steel Powder Coated Black / PU Castors



EMBOSS CHAIR - WHITE

Code: ICEMVSBL
 Seat Height: 450(H)
 550(W) x 500(D) x 830(H)
 Material:
 Seat & Back - UV Protected Plastic
 Base - Steel Chrome Finish
 *Interchangeable Base & Seat



New DESIGN



BERKELEY - BLACK

Code: ICBEMBPUBL
 Seat Height: 440 - 540(H)
 580(W) x 630(D) x 880 - 960(H)
 Material:
 Seat - Synthetic Leather
 Base - Black Aluminium 5 Way Base



New DESIGN



BERKELEY - TAN

Code: ICBEMBPUTA
 Seat Height: 440 - 540(H)
 580(W) x 630(D) x 880 - 960(H)
 Material:
 Seat - Synthetic Leather
 Base - Black Aluminium 5 Way Base





High Back



Mid Back

MILANO GROUP

Code: ICMIGR
 Seat Height: 465 - 550(H)
 High Back: 580(W) x 630(D) x 1070 - 1150(H)
 Mid Back: 580(W) x 630(D) x 880 - 960(H)
 Material:
 Seat - Synthetic Leather
 Base - Polished Aluminium 5 Way Base



MILANO CANTILEVER

Code: ICMIGRCASL
 Seat Height: 475(H)
 580(W) x 620(D) x 880(H)
 Material:
 Seat - Synthetic Leather
 Base - Polished Aluminium



LINC TASK - NYLON

Code: ICLIMBTABL
 Seat Height: 440 - 570(H)
 690(W) x 660(D) x 910 - 1095(H)
 Material:
 Back - Mesh
 Seat - Fabric Upholstered
 Base - Nylon



LINC TASK - ALUMINIUM

Code: ICLIMBTAPA
 Seat Height: 440 - 570(H)
 690(W) x 660(D) x 910 - 1095(H)
 Material:
 Back - Mesh
 Seat - Fabric Upholstered
 Base - Polished Aluminium 5 Way



TEKTRON EXECUTIVE

Code: ICTEEXLEBL
 Seat Height: 455 ~ 575(H)
 675(W) x 630(D) x 1150 - 1270(H)
 Material:
 Seat - Soft PU
 Back - Mesh
 Base - Nylon with SS Cover 5 Way



TEKTRON DIRECTOR

Code: ICTEDRLEBL
 Seat Height: 455 ~ 575(H)
 675(W) x 630(D) x 1150 ~ 1270(H)
 Material:
 Seat - Leather
 Back - Leather
 Base - Nylon with SS Cover 5 Way





TURIN CANTILEVER

Code: ICTUGRCASL

Seat Height: 460(H)

580(W) x 620(D) x 880(H)

Material:

Seat - Synthetic Leather

Base - Polished Aluminium



BERLIN

Code: ICBEMBCASL

Seat Height: 470(H)

590(W) x 590(D) x 1000(H)

Material:

Seat - Synthetic Leather

Base - Polished Aluminium



KEY TASK

Code: ICKYMBMEBL

Seat Height: 435 - 535(H)

620(W) x 580(D) x 920 - 1020(H)

Material:

Back - Mesh

Seat - Fabric Upholstered

Base - Nylon 5 Way Base



ELWOOD TASK

Code: ICEWMBMEBL

Seat Height: 460 - 560(H)

690(W) x 600(D) x 925 - 1025(H)

Material:

Back - Mesh

Seat - Fabric Upholstered

Base - Polished Aluminium 5 Way Base



New DESIGN



OPTIMA EXECUTIVE

Code: ICOPMEBAEXBL

Seat Height: 470 - 555(H)

670(W) x 640(D) x 1115 - 1225(H)

Material:

Seat - Fabric

Back - Mesh

Base - Aluminium 5 Way Base



COBRA

Code: ICCBEXLEBL

Seat Height: 425 - 510(H)

660(W) x 590(D) x 975-1055(H)

Material:

Seat - Genuine Leather

Base - Polished Aluminium 5 Way

Base





Each piece is custom made in our workshop, simply choose your style, size and colour. Inspirations below; or create your own design. It is time to get excited about the possibilities.

SLIM LINE TABLE

Base Finish: Black / White
 Melamine Top: **Colour Swatches page 54 (Eo Board)**
 Custom made to size



SLIM CUBE- RECTANGLE COFFEE TABLE

Base Finish: Black / White
 Melamine Top: **Colour Swatches page 54 (Eo Board)**
 Custom made to size



SLIM CUBE- SQUARE COFFEE TABLE

Base Finish: Black / White
 Melamine Top: **Colour Swatches page 54 (Eo Board)**
 Custom made to size



BENCH PRESS TABLE

Base Finish: Black / White
 Tubular Welded
 Melamine Top: **Colour Swatches page 54 (Eo Board)**
 Custom made to size



DIAMOND CROSS TABLE

Base Finish: Black / White
 Melamine Top: **Colour Swatches page 54 (Eo Board)**
 Custom Made to size



BREAKOUT BENCH

Base Finish: Black / White
 Top: Timber or Melamine
 Custom made to size



WALKWAY PLANTER BOX

New DESIGN



Artificial Dracaena Plant
Plant: 550W x 550D x 600H

BL WT

Frame Finish: Powder-coated Black / White
Melamine Panels: **Colour Swatches page 54 (Eo Board)**

CODE	DIMENSION
WLKPL0905	900W x 450D x 810H
OPTION	Plants + Pebbles or Dark Barks

GARDEN POST

New DESIGN

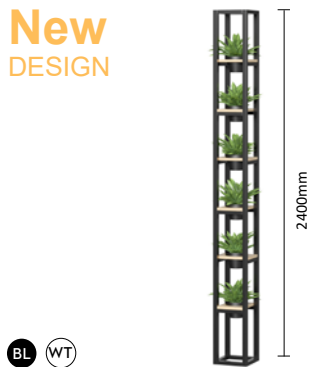

BL WT

Frame Finish: Powder-coated Black / White
Melamine Panels: **Colour Swatches page 54 (Eo Board)**

CODE	DIMENSION
HIMTPL180303	300W x 300D x 1800H
HIMTPL180303	300W x 300D x 2400H

BREEZEWAY VERTICAL GARDEN

New DESIGN



BL WT

(Plant B included)

Frame Finish: Powder-coated Black / White
Melamine Panels: **Colour Swatches page 54 (Eo Board)**

CODE	DIMENSION
BREPL1235	1200W x 350D x 1800H

VERTICAL GARDEN WALL

25mm Melamine Structure
Finish Option: **Colour Swatches page 54 (Eo Board)**



(2700W x 2700H shown)



Option A - \$ 10 per plant
Overall Size: 250 x 250



Option B - \$ 25 per plant
Overall Size: 420 x 420

Plant Option A (6 Shelves Per Column)

CODE	DIMENSION	NO OF COLUMNS	NO OF PLANTS
VGW62718	1800W x 200D x 2700H	6	36
VGW62721	2100W x 200D x 2700H	7	42
VGW62724	2400W x 200D x 2700H	8	48
VGW62727	2700W x 200D x 2700H	9	54

Plant Option B (5 Shelves Per Column)

CODE	DIMENSION	NO OF COLUMNS	NO OF PLANTS
VGW52718	1800W x 200D x 2700H	6	30
VGW52721	2100W x 200D x 2700H	7	35
VGW52724	2400W x 200D x 2700H	8	40
VGW52727	2700W x 200D x 2700H	9	45

RECEPTION CONSOLE

Base Finish: Black / White
Finish Option: **Colour Swatches page 54 (Eo Board)**

New DESIGN



CODE	DIMENSION
RECO120408	1200W x 400D x 800H

AVERY STORAGE

Base Finish: Black / White
Finish Option: **Colour Swatches page 54 (Eo Board)**

New DESIGN



CODE	DIMENSION
AVST180945	900W x 450D x 1800H

GARDEN LOCKERS (Metal & Melamine Design)

Great room dividers & Storage solution
Metal Base Finish: Black / White
Melamine Lockers: **Colour Swatches page 54 (Eo Board)**
Custom made to size

New DESIGN



(2 base of 1200W shown - Plant B included)

CODE	DIMENSION
GDLK1205188L	1200W x 500D x 1900H
Each Locker Size	300W x 500D x 600H

Solids, Cool Toned Woodgrains and Textures

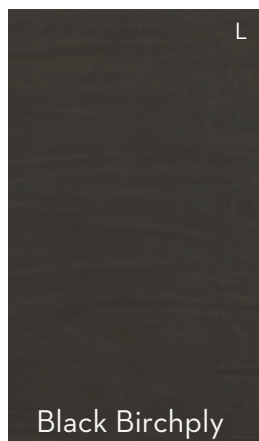
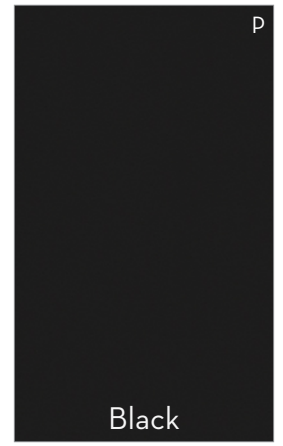
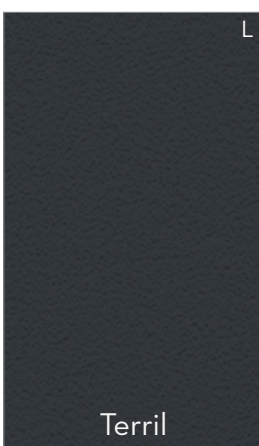
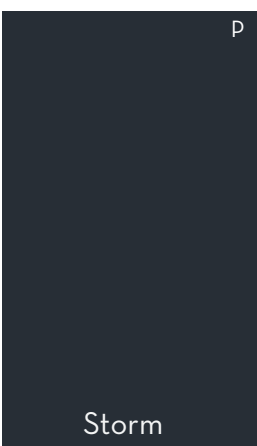
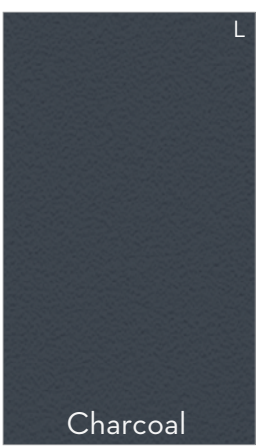
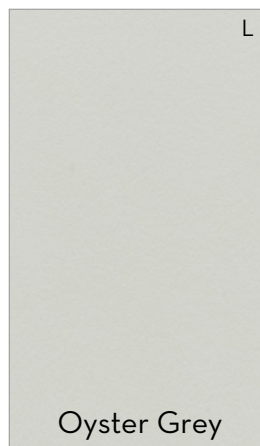
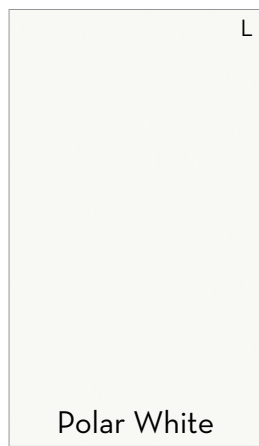
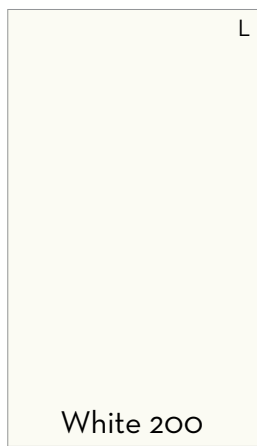
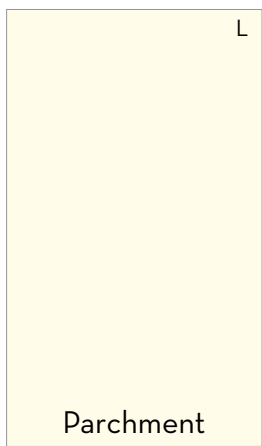

Woodgrains

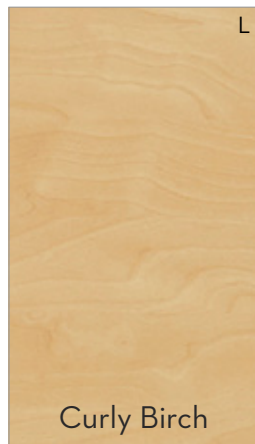

Pop and Education Colours

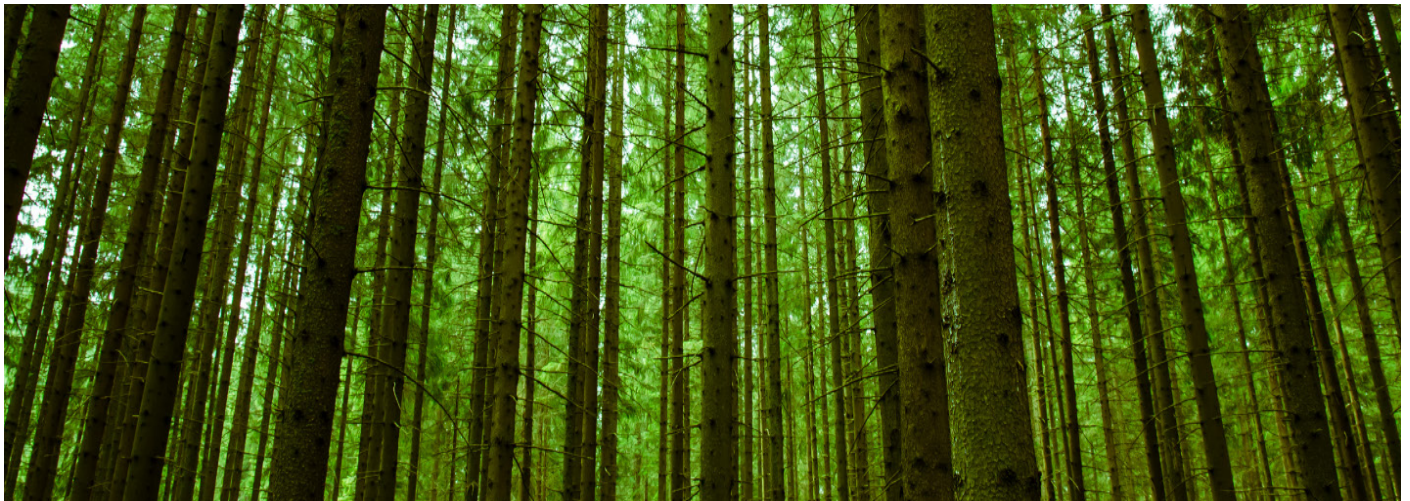
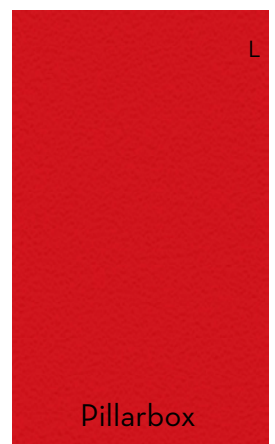
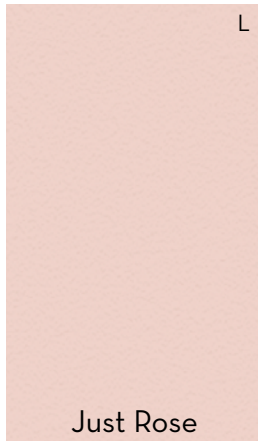
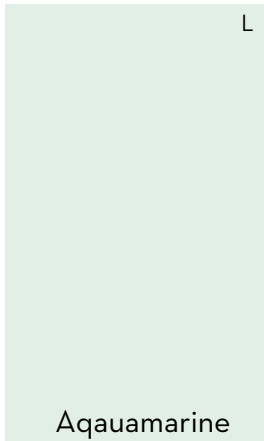

Our commercial range comes in a variety of colours, thicknesses and sheet sizes specifically designed for commercial application. Our range of colours are available in MELAMINE making it easy for you to choose the design features you are looking for.

The commercial range will inspire unlimited design possibilities for any commercial environment and give your design concept a fresh and unique look.

Our commercial range is committed to an eco-friendly and sustainable environment. It is an intrinsic part of the way we do business daily.

Our decisions are made so that they have minimum negative impact on the environment. Our product is manufactured from managed and renewable plantation pine and is Australian Forestry Standard chain of custody certified. All products are manufactured from E0 or E1.

- L Laminex
- P polytec
- F FORMICA®



* Subject to change, some colours may not apply *

- 18mm / 25mm Standard Particleboard
- MDF Board available on request - \$ P.O.A
- Other Board and Colour specifications are welcome \$ P.O.A (Please refer to our sales representative for more information)





ACCENT COLLECTION

Accent - Desking



PANEL END DESK

Top: Melamine 25mm Thickness
 Side/ Square Corners: Melamine 25mm Thickness
 Adjustable Feet

CODE	DIMENSION
IFDE1206	1200W x 600D x 725H
IFDE1207	1200W x 750D x 725H
IFDE1507	1500W x 750D x 725H
IFDE1807	1800W x 750D x 725H
IFDE1809	1800W x 900D x 725H
IFDE2109	2100W x 900D x 725H
OPTION	Fully Assembled



FIXED PANEL END DESK RETURN

Top: Melamine 25mm Thickness
 Side/ Square Corners: Melamine 25mm Thickness
 Adjustable Feet
 Can be Assembled & Fitted to Left or Right Side

CODE	DIMENSION
IFFR0904	900W x 450D x 725H
IFFR0906	900W x 600D x 725H
OPTION	Fully Assembled



Other Colours Available
 see page 60



Other Colours Available
see page 60



BOAT SHAPED BOARD TABLE

Top: Melamine 25mm Thickness
Base: Melamine 25mm Thickness
Adjustable Feet
Double Modesty 'H' Base

CODE	DIMENSION
IFBOTB24	2400W x 1200D x 725H
OPTION	Fully Assembled



ROUND TOP TABLE

Top: Melamine 25mm Thickness
Base: Cross Base Melamine 25mm Thickness
Adjustable Feet

CODE	DIMENSION
IFRDTA09	Ø900 x 725H
IFRDTA12	Ø1200 x 725H
OPTION	Fully Assembled

Accent - Workstation



2 PIECE RADIAL WORKSTATION

Top: Melamine 25mm Thickness
Side/ Square Corners: Melamine 25mm Thickness
600mm Deep Left or Right Side Return
2 Cable Holes & Adjustable Feet

CODE	DIMENSION
IFWSLH	1800W x 750D 1800W x 600D x 725H
IFWSRH	1800W x 750D 1800W x 600D x 725H
OPTION	Fully Assembled



3 PIECE SPLAY WORKSTATION

Top: Melamine 25mm Thickness
1 Cable Hole
Side/ Square Corners: Melamine 25mm Thickness
Adjustable Feet

CODE	DIMENSION
IF3PWS1506	1500W x 1500W x 600D x 725H
IF3PWS1806	1800W x 1800W x 600D x 725H
IF3PWS1807	1800W x 1800W x 750D x 725H
OPTION	Fully Assembled

Accent - Fixed Pedestal



Other Colours Available
see page 60



2 SMALL DRAWERS

Fixed Storage Unit No Lock
Fits Under Desk/ Workstation/ 600D Return
Partially Assembled in Carton

CODE	DIMENSION
IFFPS	404W x 505D x 297H
OPTION	Fully Assembled



1 SMALL DRAWER + 1 FILE DRAWER

Fixed File Storage Unit
Fits Under Desk/ Workstation/ 600D Return
Includes Master-Key Lock

CODE	DIMENSION
IFFP2L	404W x 505D x 445H
OPTION	Fully Assembled



3 SMALL DRAWERS

Fixed Storage Unit
Fits Under Desk/ Workstation/ 600D Return
Includes Master-Key Lock
Partially Assembled in Carton

CODE	DIMENSION
IFFP3L	404W x 505D x 445H
OPTION	Fully Assembled

Accent - Buffet & Bookcase



SLIDING DOOR BUFFET

Solid Back + 25mm Top
Includes Master- Key Lock
Adjustable Shelves
Adjustable Feet

CODE	DIMENSION
IFBUSL12 (2 Doors + 2 Shelves)	1200W x 450D x 725H
IFBUSL15 (2 Doors + 2 Shelves)	1500W x 450D x 725H
IFBUSL18 (2 Doors + 2 Shelves)	1800W x 450D x 725H
OPTION	Fully Assembled



HINGED DOOR BUFFET

Solid Back + 25mm Top
Includes Master- Key Lock
Adjustable Shelves
Adjustable Feet

CODE	DIMENSION
IFBUHGL09 (2 Doors + 1 Shelf + 1 Lock)	900W x 450D x 725H
OPTION	Fully Assembled



OPEN BOOKCASE

Solid Back + 25mm Top & 18mm Side
Adjustable Shelves with Cliphook Support
Adjustable Feet

CODE	DIMENSION
IFBC09 (1 Shelf)	900H x 900W x 300D
IFBC12 (2 Shelves)	1200H x 900W x 300D
IFBC15 (3 Shelves)	1500H x 900W x 300D
IFBC18 (4 Shelves)	1800H x 900W x 300D
IFBCSH	Extra Shelf
OPTION	Fully Assembled

Accent - Mobile Pedestal & Filing Cabinet



Other Colours Available
see page 60



2 SMALL DRAWERS + 1 FILE DRAWER

Mobile Storage Unit
Includes Master-Key Lock
Partially Assembled in Carton

CODE	DIMENSION
IFMP3L	406W x 510D x 670H
OPTION	Fully Assembled



4 SMALL DRAWERS

Mobile Storage Unit
Includes Master-Key Lock
Partially Assembled in Carton

CODE	DIMENSION
IFMP4L	406W x 510D x 670H
OPTION	Fully Assembled



CABINET - 4 FILE DRAWERS

25mm Top/ 18mm Side & Drawer Front
Full Extension Runners with Adjustable Feet
Includes Master-Key Lock
Partially Assembled in Carton

CODE	DIMENSION
IFFC4L	1200H x 465W x 505D
OPTION	Fully Assembled

Accent - Cupboard & Hutch



STATIONERY CUPBOARD

Solid Back + 25mm Top & 18mm Side
2 Full Hinged Doors with Master- Key Lock
4 Adjustable 25mm Shelves
Adjustable Feet

CODE	DIMENSION
IFSCLO9	1800H x 900W x 450D
OPTION	Fully Assembled



STORAGE CUPBOARD/ BOOKCASE

Solid Back + 25mm Top & 18mm Side
2 Half Hinged Doors with Master- Key Lock
2 Adjustable 25mm Shelves (Bookcase)
1 Adjustable 25mm Shelf (Cupboard)
Adjustable Feet

CODE	DIMENSION
IFCPBC	1800H x 800W x 450D
OPTION	Fully Assembled



ADJUSTABLE SHELF HUTCH

Solid Back + 25mm Top & 18mm Side
Adjustable 25mm Shelves
Plastic Corner Connectors

CODE	DIMENSION
IFHU12 (4 Shelves)	1200W x 300D x 1075H
IFHU15 (4 Shelves)	1500W x 300D x 1075H
IFHU18 (4 Shelves)	1800W x 300D x 1075H
OPTION	Fully Assembled

COLOR SWATCH

Melamine

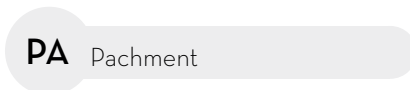
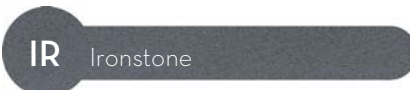
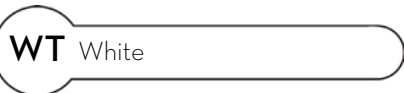

Plastic

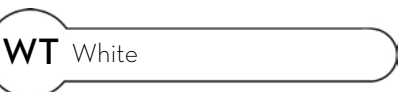

Mesh



Metal

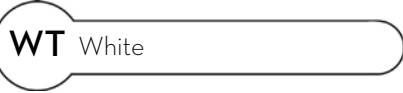

Fabric

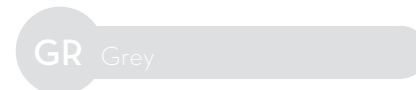

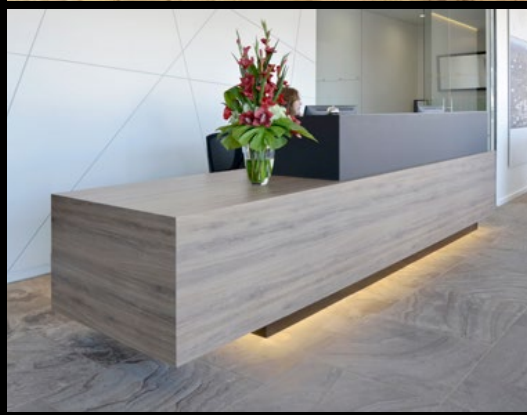



OFFICE SEATING

EXPRESS RANGE

THE FOLLOWING PRODUCT RANGE IS ONLY AVAILABLE IN THE COLOURS AS STATED IN THE SPECIFICATIONS

CAN BE SHIPPED WITHIN A WEEK OF ORDERING.



Warranty period for chairs, lounges and tables



Weight rating for individual chairs, lounges and tables*



Fully imported Chairs , lounges, tables, parts and components.



The Performance criteria adopted for certification by Furntech is based on Australian standards, e.g. Level 6 - Severe commercial and heavy industrial.*

**Weight limits are self-rated by Style Ergonomic Australia. AFRDI approved chairs are normally rated to 110kg.*



Furntech is an independent not-for-profit technical organisation providing standards, testing product certification and research for buyers and sellers of furniture.

AFRDI 142
Certification



AFRDI rating for multi shift use and 160kg weight limit.



BIFMA is a third-party certification program that provides manufacturers with valuable feedback for evaluating the environmental, human, and social impacts of their furniture products for manufacturing, facility, and organisation.

R4 EXECUTIVE SEATING

WEB RANGE



FEATURES

- » Adjustable seat height
- » Adjustable seat and back angle
- » Adjustable weight tension
- » Fixed chrome arms
- » Available in high and low back
- » Knee tilt mechanism with 3 locking positions
- » 700mm aluminium base
- » Available in black, red and white PU only
- » Minor assembly required
- » Suitable for indoor use only
- » 5 year warranty
- » Weight limit is 120kg

COLOUR



B-Black R-Red W-White



WEB-HB



WEB-LB



WEB-HR



WEB-LR



WEB-HW



WEB-LW

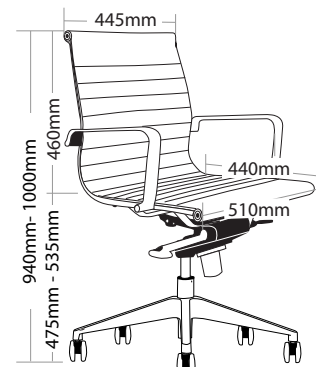
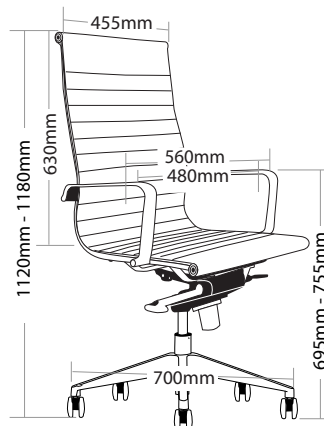

AQUA RANGE



FEATURES

- » Adjustable seat height
- » Adjustable back height (ratchet)
- » Adjustable seat and back angle
- » Optional adjustable arms
- » Available in high and low back
- » Moulded seat and back foam
- » 3 lever ergonomic mechanism
- » 600mm black nylon base
- » Available in Metro black only
- » AFRDI tested to level 6
- » Minor assembly required
- » Suitable for indoor use only
- » 7 year warranty
- » Weight limit is 130kg



AQUA-L-MB



AQUA-LC-MB

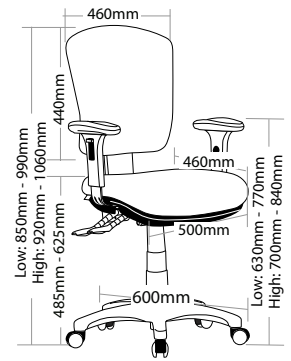

AQUA-H-MB



AQUA-HC-MB

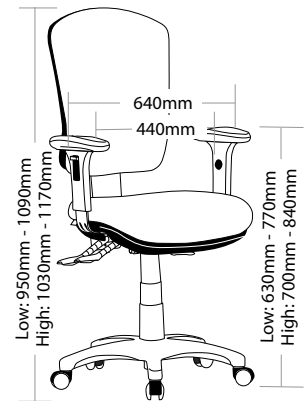

CLICK RANGE



FEATURES

- » Adjustable seat height
- » Adjustable back height (ratchet)
- » Adjustable seat and back angle
- » Optional adjustable arms
- » Available in high and low back
- » Moulded seat and back foam
- » Square seat
- » 3 lever ergonomic mechanism
- » 660mm black nylon base
- » Available in Metro black only
- » AFRDI tested to level 6
- » Minor assembly required
- » Suitable for indoor use only
- » 7 year warranty
- » Weight limit is 130kg



CLICK-L-MB



CLICK-LC-MB

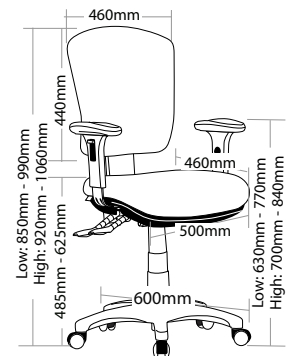

CLICK-H-MB



CLICK-HC-MB

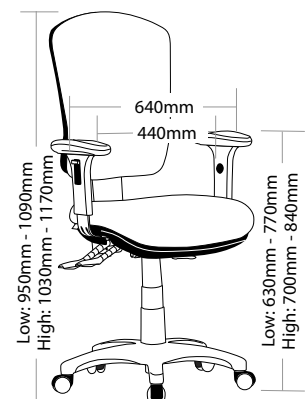

HINO RANGE



FEATURES

- » Adjustable seat height
- » Adjustable back height (ratchet)
- » Adjustable seat and back angle
- » Adjustable weight tension
- » Optional adjustable arms
- » Moulded seat foam
- » Mega big boy seat
- » Mesh back
- » 3 lever heavy duty ergonomic mechanism
- » 700mm black nylon base
- » Chair not available with drafting kit
- » Available in Metro black only
- » AFRDI tested to level 6
- » Minor assembly required
- » Suitable for indoor use only
- » 7 year warranty
- » Weight limit is 140kg



HINO-MB

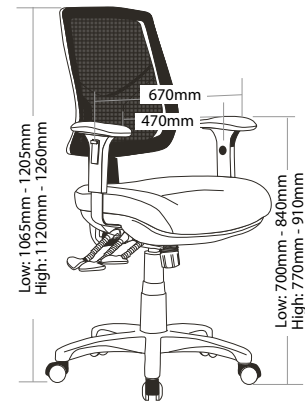
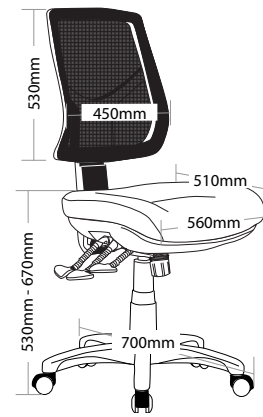

CHEVY RANGE

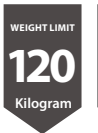

FEATURES

- » Adjustable seat height
- » Adjustable seat and back angle
- » Adjustable weight tension
- » Mesh back
- » Fixed arms
- » Knee tilt mechanism with 3 locking positions
- » 700mm black nylon base
- » Available in black only
- » Minor assembly required
- » Suitable for indoor use only
- » 5 year warranty
- » Weight limit is 120kg



CHEVY

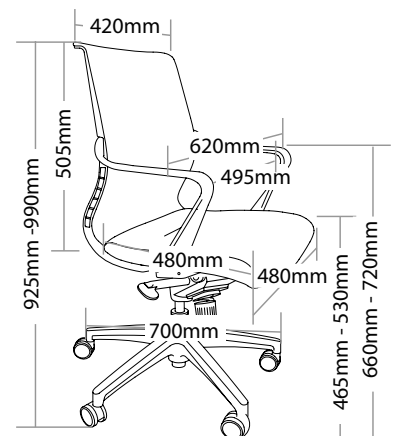

VOLT RANGE



» FEATURES

- » Adjustable seat height
- » Adjustable seat and back angle
- » Adjustable weight tension
- » Fixed arms
- » Knee tilt mechanism with 3 locking positions
- » 660mm heavy duty black aluminium base
- » Black powder coated frame
- » Available in black mesh, terracotta PU, tan PU and black PU
- » Minor assembly required
- » Suitable for indoor use only
- » 5 year warranty
- » Weight limit is 130kg

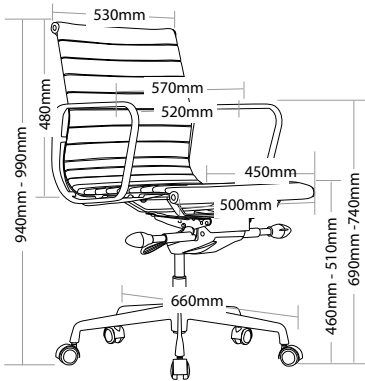

VOLT-ME



VOLT-TE



VOLT-TA



VOLT-BL

R4 EXECUTIVE SEATING

HILTON RANGE



FEATURES

HILTON-H/ HILTON-L

- » Adjustable seat height
- » Adjustable seat and back angle
- » Adjustable weight tension
- » Adjustable arms
- » Available in high and low back
- » Synchron mechanism with 3 locking positions
- » 700mm large black nylon base
- » Available in black PU only
- » Minor assembly required
- » Suitable for indoor use only
- » 5 year warranty
- » Weight limit is 120kg

HILTON-VC

- » Black metal frame
- » Available in black PU only
- » Minor assembly required
- » Suitable for indoor use only
- » 5 year warranty
- » Weight limit is 120kg



HILTON-H



HILTON-L



HILTON-VC

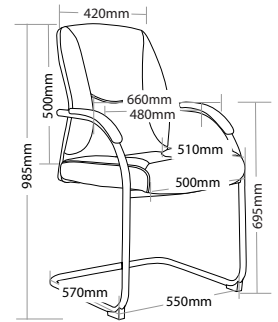
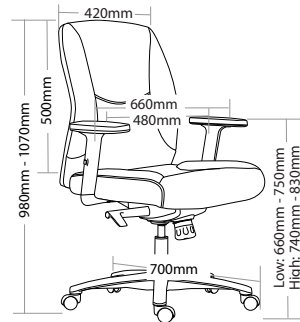
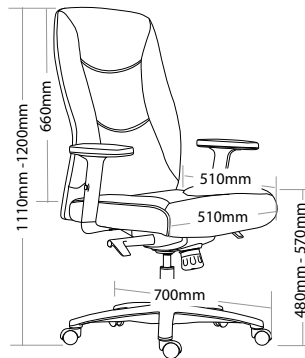

CRUZ RANGE



FEATURES

- » Adjustable seat height
- » Adjustable seat and back angle
- » Adjustable weight tension
- » Fixed chrome arms
- » Available in high and low back
- » Knee tilt mechanism with 3 locking positions
- » 700mm aluminium base
- » Available in black PU only
- » Minor assembly required
- » Suitable for indoor use only
- » 5 year warranty
- » Weight limit is 120kg



CRUZ-H



CRUZ-L

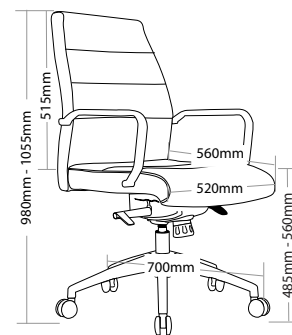
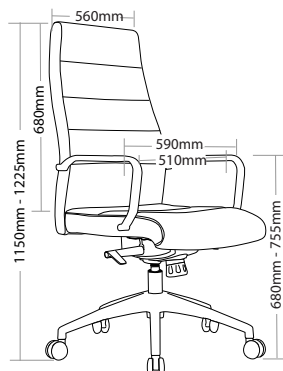

BOSTON RANGE



FEATURES

BOSTON-H/ BOSTON-L

- » Adjustable seat height
- » Adjustable seat and back angle
- » Adjustable weight tension
- » Adjustable aluminium arms
- » Available in high and low back
- » High density foam
- » Synchron mechanism with 3 locking positions
- » 700mm aluminium base
- » Available in black PU only
- » Minor assembly required
- » Suitable for indoor use only
- » 5 year warranty
- » Weight limit is 120kg

BOSTON-VC

- » Chrome frame
- » High density foam
- » Available in black PU only
- » Minor assembly required
- » Suitable for indoor use only
- » 5 year warranty
- » Weight limit is 120kg



BOSTON-H



BOSTON-L



BOSTON-VC

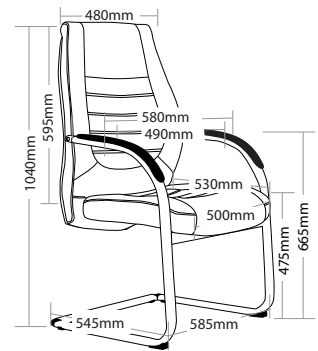
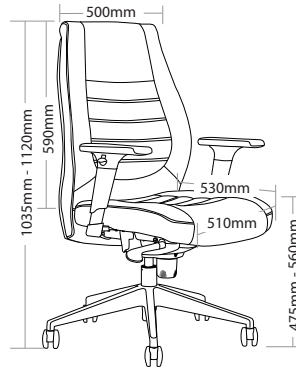
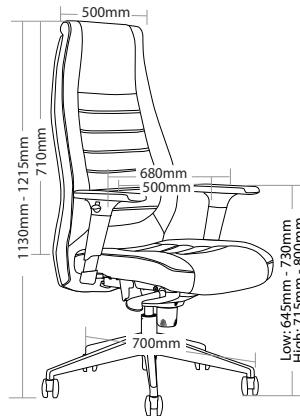

FLASH RANGE



FEATURES

FLASH-H/ FLASH-L

- » Adjustable seat height
- » Adjustable seat and back angle
- » Adjustable weight tension
- » Fixed arms
- » Available in high and low back
- » Knee tilt mechanism with 3 locking positions
- » 700mm aluminium base
- » Aluminium frame
- » Available in black leather only
- » Minor assembly required
- » Suitable for indoor use only
- » 5 year warranty
- » Weight limit is 120kg

FLASH-VC

- » Aluminium cantilever frame
- » Available in black leather only
- » Minor assembly required
- » Suitable for indoor use only
- » 5 year warranty
- » Weight limit is 120kg



FLEX1H



FLEX1L



FLVC1

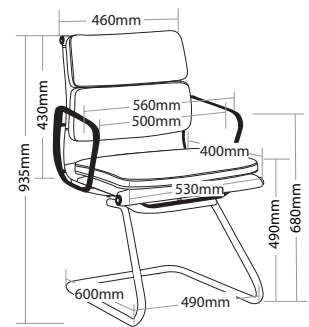
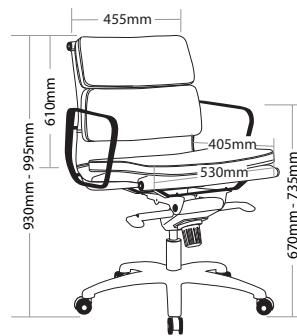
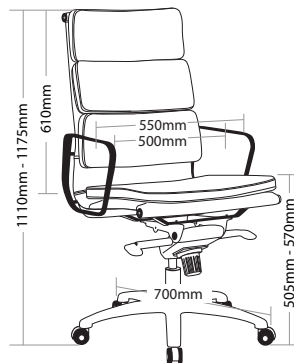

R4 EXECUTIVE SEATING

MAGNUM RANGE



FEATURES

MAGNUM-H/MAGNUM-L

- » Adjustable seat height
- » Adjustable seat and back angle
- » Adjustable weight tension
- » Fixed aluminium arms
- » Available in high and low back
- » Moulded seat and back foam
- » Knee tilt mechanism with 3 locking positions
- » 700mm aluminium base
- » Extremely comfortable
- » Available in black leather only
- » Suitable for indoor use only
- » 5 year warranty
- » Weight limit is 120kg

MAGNUM-VC

- » Fixed aluminium arms
- » Chrome cantilever frame
- » Extremely comfortable
- » Available in black leather only
- » Suitable for indoor use only
- » 5 year warranty
- » Weight limit is 120kg



MAGNUM-H



MAGNUM-L



MAGNUM-VC

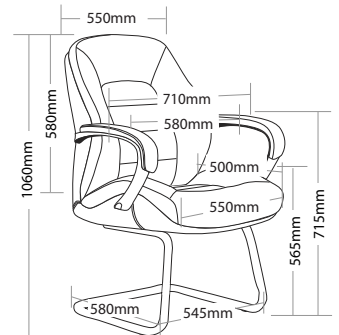
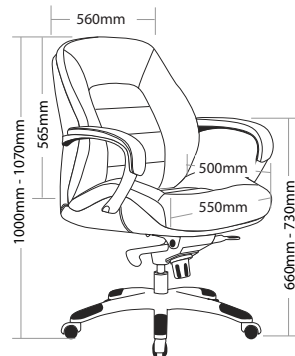
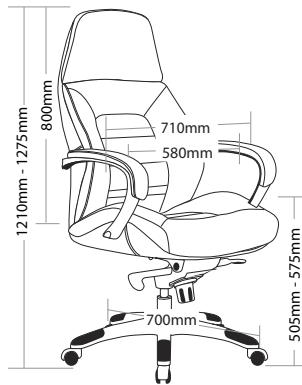

NEO RANGE



FEATURES

- » Not available with arms
- » Stackable
 - » Maximum 5 chairs on floor
- » Square tube
- » Mesh back
- » Padded seat
- » Black metal frame
- » Available in black only
- » Minor assembly required
- » Suitable for indoor use only
- » 3 year warranty
- » Weight limit is 120kg



NEO

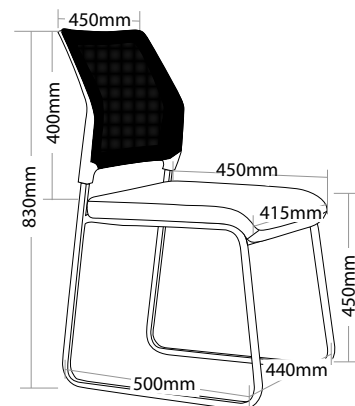

VINN RANGE

WARRANTY
4
 Year

WEIGHT LIMIT
120
 Kilogram

IMPORTED

FEATURES

- » Optional plastic or mesh back
- » Optional arms, tablet arm or stool
- » Optional black metal trolley, easy to move when stacked
- » Available in beam seating
- » Stackable
 - » Maximum 13 chairs on trolley
 - » Maximum 5 chairs on floor
 - » Maximum 3 chairs with stools or arms
- » Not stackable with tablet arms or stool with arms
- » Linkable except with tablet arms or arms
- » Chrome finish
- » Black plastic
- » Plastic under pan
- » Solid steel sled base frame
- » Available in black only
- » Suitable for indoor use only
- » 4 year warranty
- » Weight limit is 120kg



VINN-B



VINN-BA



VINN-BT



VINN-TRL



VINN-MB



VINN-MBA



VINN-MBT



VINN-B-ST



VINN-B-STA



VINN-MB-ST



VINN-MB-STA

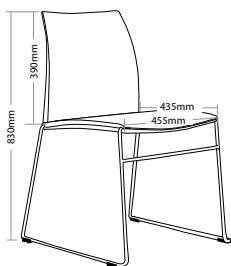

VINN-B

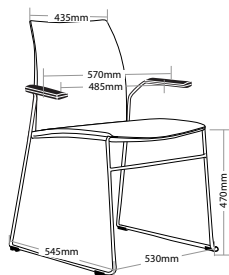

VINN-BA

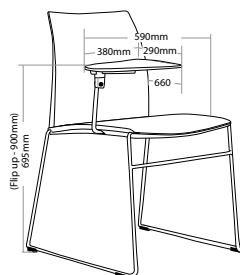

VINN-BT

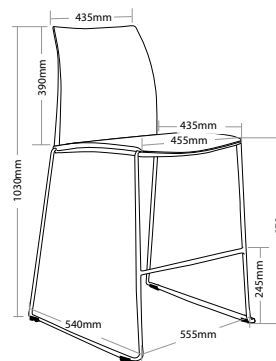

VINN-B-ST

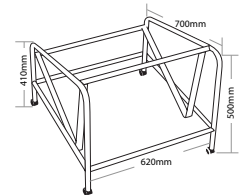

VINN-TRL

POD SLED RANGE



POD-SB



POD-SR



POD-SW

FEATURES

- » Optional arms
- » Optional tablet arm
- » Optional black metal trolley, easy to move when stacked
- » Optional 4 legs or sled base chrome frame
- » Available in beam seating
- » Stackable
 - » Maximum 13 chairs on trolley
 - » Maximum 5 chairs on floor
 - » Not stackable with arms or tablet arms
- » Linkable except with tablet arms and arms
- » Plastic under pan
- » Available in black, red and white only
- » Suitable for indoor use only
- » 4 year warranty
- » Weight limit is 120kg



POD-SBA



POD-SRA



POD-SWA

COLOUR



B-Black R-Red W-White



POD-SBT



POD-SRT



POD-SWT



POD-TRL

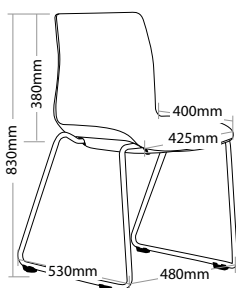

POD-S

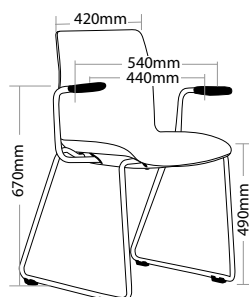

POD-SA

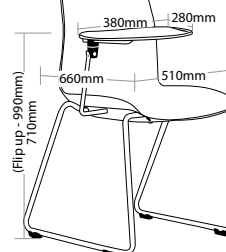

POD-ST

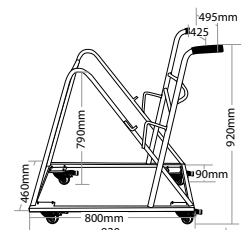

POD-TRL

R6 BEAM SEATING

POD RANGE

WARRANTY
4
 Year

WEIGHT LIMIT
200
 Kilogram

WEIGHT LIMIT
300
 Kilogram

WEIGHT LIMIT
350
 Kilogram

IMPORTED

FEATURES

- » Optional 2, 3 or 4 seater
- » Heavy duty black metal beam frame
- » Adjustable feet
- » Available in black, red and white only
- » Minor assembly required
- » Suitable for indoor use only
- » 4 year warranty
- » Weight limit for 2 seater is 200kg
- » Weight limit for 3 seater is 300kg
- » Weight limit for 4 seater is 350kg

COLOUR



WEIGHT LIMIT
200
Kilogram



WEIGHT LIMIT
300
Kilogram



WEIGHT LIMIT
350
Kilogram

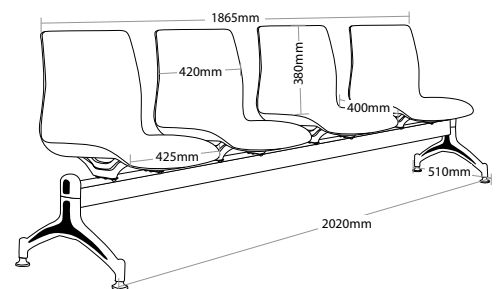
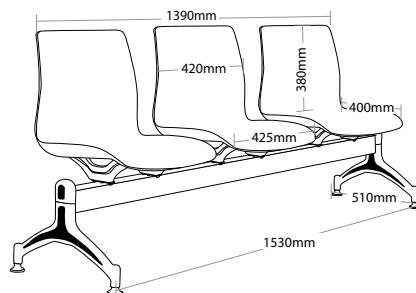
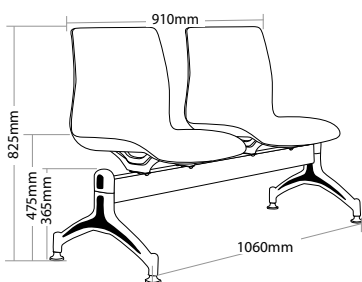

R7 BREAKOUT SEATING

TONIC RANGE



FEATURES

- » High density seat foam
- » Moulded back foam
- » Solid rod base sled chrome frame
- » Available in Sega charcoal and red only
- » Minor assembly required
- » Suitable for indoor use only
- » 5 year warranty
- » Weight limit is 120kg

COLOUR



TONIC-C



BACK VIEW



TONIC-R

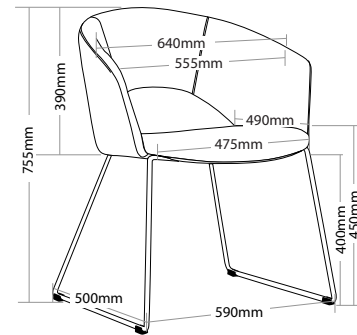

TECHNO RANGE



FEATURES

- » High density foam
- » Linkable
- » Plywood inner frame
- » Chrome metal feet
- » Available in black PU only
- » Minor assembly required
- » Suitable for indoor use only
- » 2 Year warranty
- » Weight limit is 120kg



TECHNO-1

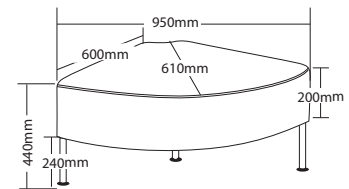

TECHNO-2

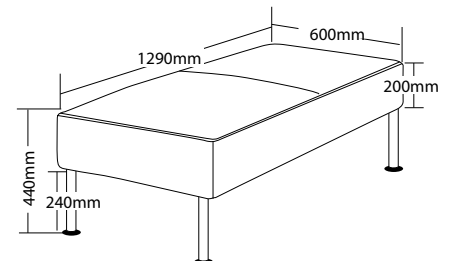

TECHNO-B

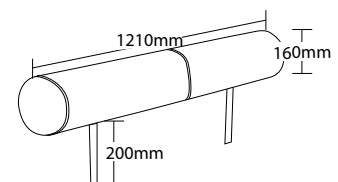

DEMO RANGE



FEATURES

- » Adjustable seat height
- » Swivel seat
- » Moulded foam
- » 700mm aluminium 4 star base
- » Plywood shell
- » Available in black and white PU only
- » Minor assembly required
- » Suitable for indoor use only
- » 5 year warranty
- » Weight limit is 120kg

COLOUR



DEMO-B



SIDE VIEW



DEMO-W

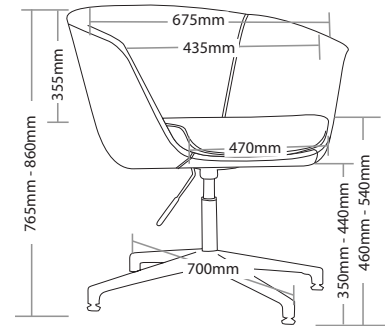

ORION RANGE



FEATURES

- » High density foam
- » Steel frame
- » Plastic feet
- » Available in black PU only
- » Minor assembly required
- » Suitable for indoor use only
- » 3 year warranty
- » Weight limit is 120kg



ORION

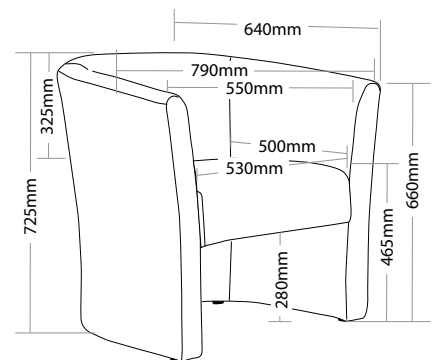

JADEN RANGE



FEATURES

- » Optional 1 or 2 seater
- » High density foam
- » Stainless steel frame
- » Solid timber inner frame
- » Available in black PU only
- » Minor assembly required
- » Suitable for indoor use only
- » 5 year structural warranty
- » Weight limit for 1 seater is 130kg
- » Weight limit for 2 seater is 260kg



JADEN-1

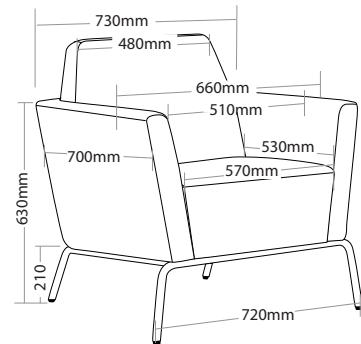

JADEN-1

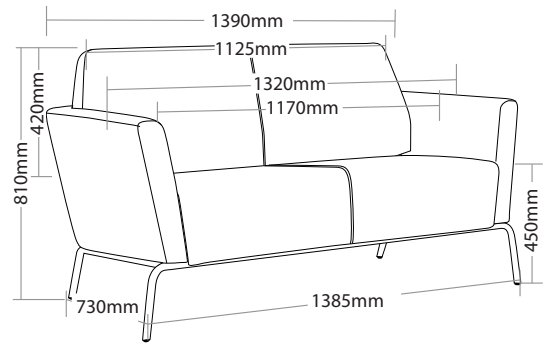

RUBY RANGE



FEATURES

- » Steel frame
- » Stainless steel legs
- » Suitable for indoor use only
- » Available in black, red and white PU only
- » Minor assembly required
- » Suitable for indoor use only
- » 5 year warranty
- » Weight limit is 120kg



RUBY-B



RUBY-R



RUBY-W

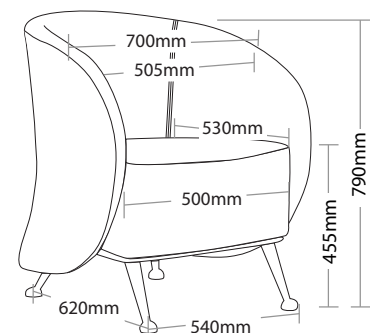

COLOUR



PLAZA RANGE



FEATURES

- » Optional 1, 2 or 3 seater
- » Pocket spring seat
- » Loose cushions upholstered both sides
- » Zig zag steel spring
- » Webbed base
- » Solid hardwood frame
- » Stainless steel feet
- » Available in black PU only
- » Minor assembly required
- » Suitable for indoor use only
- » 5 year warranty
- » Weight limit for 1 seater is 130kg
- » Weight limit for 2 seater is 260kg
- » Weight limit for 3 seater is 390kg

WEIGHT LIMIT
130
Kilogram



PL-2S

WEIGHT LIMIT
260
Kilogram



PL-2S

WEIGHT LIMIT
390
Kilogram



PL-3S

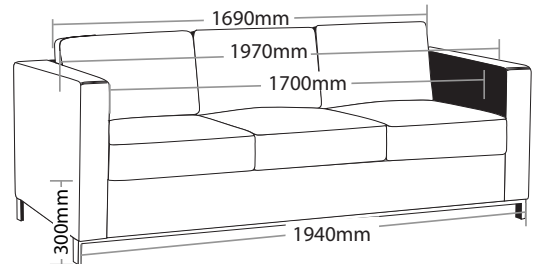
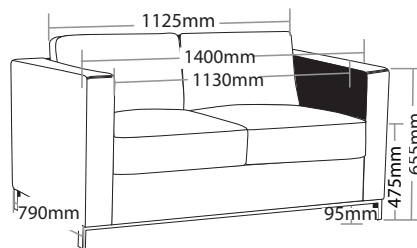
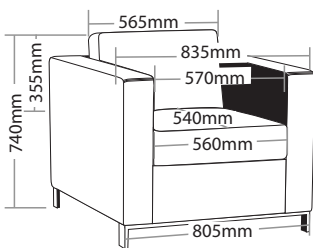

CAD RANGE



FEATURES

- » Adjustable seat height
- » Adjustable seat angle
- » Optional drafting kit
- » Optional glides or brake castors
- » Saddle seat
- » Nylon castors
- » 640mm black nylon base
- » Available in black PU only
- » Minor assembly required
- » Suitable for indoor use only
- » 5 year warranty
- » Weight limit is 120kg

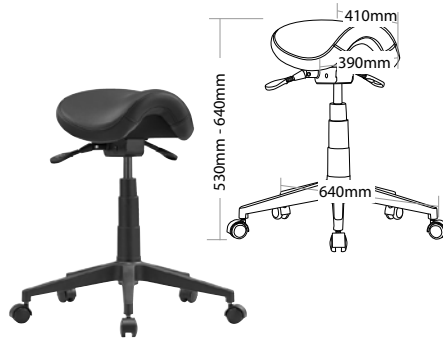

CAD

INDUSTRIAL STOOLS R9

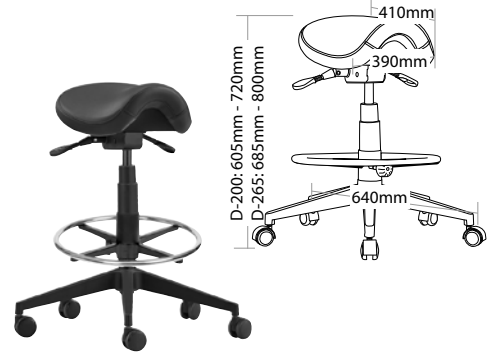

CAD-D

STAGE RANGE



FEATURES

- » Adjustable seat height
- » Adjustable back height
- » Adjustable seat and back angle
- » Optional drafting kit
- » Optional glides or brake castors
- » Saddle seat
- » 640mm Black nylon base
- » Available in black PU only
- » Minor assembly required
- » Suitable for indoor use only
- » 5 year warranty
- » Weight limit is 120kg

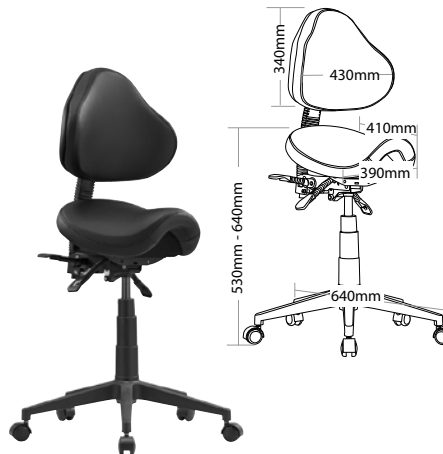

STAGE



STAGE-D

R10 ADJUSTABLE TABLES

ERGO LIFT RANGE



FEATURES

- » Adjustable height
- » Adjustable frame width
- » Adjustable feet
- » Optional with return (left or right)
- » Optional 120 degree angle
- » Optional single leg
- » Heavy duty frame
- » Easy to use also has an anti collision sensor
- » White powder coating only
- » AFRDI approved
- » Minor assembly required
- » Suitable for indoor use only
- » 7 year warranty
- » Weight limit is 160kg

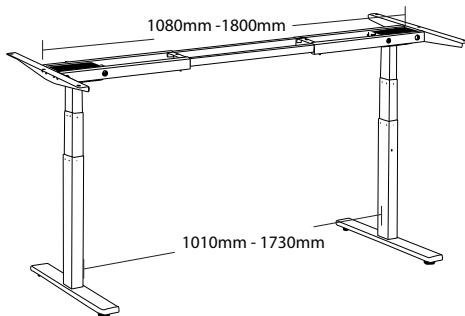
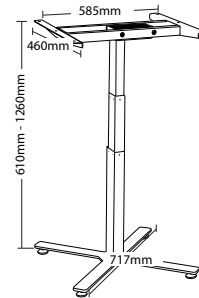

EL-DESK



EL-DLL

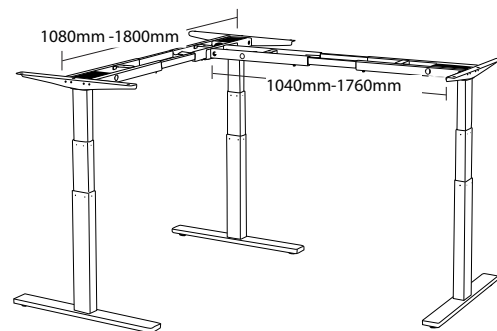



EL-DRL



EL-D120

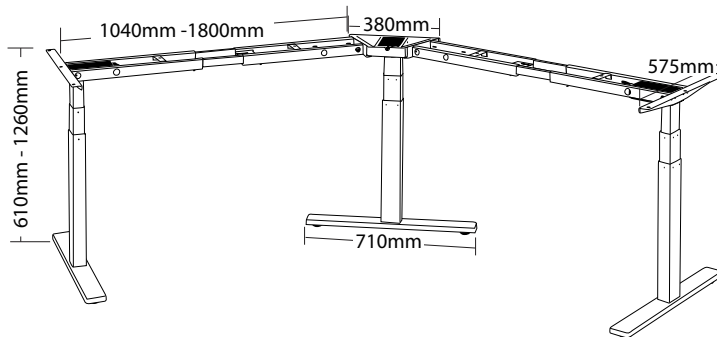

EL-DD

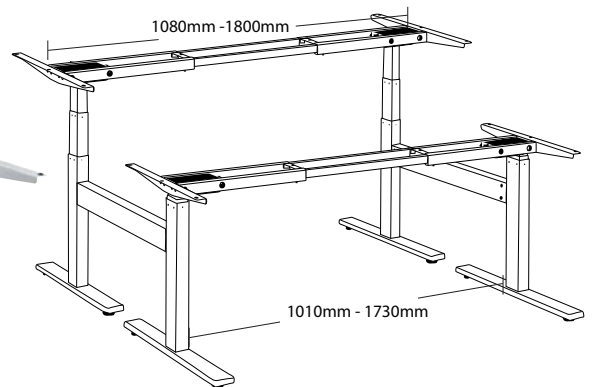

LOCALLY UPHOLSTERED

THE FOLLOWING PRODUCT RANGE IS ABLE TO BE UPHOLSTERED IN ANY FABRIC REQUIRED OR IN ANY OF THE HOUSE FABRIC RANGES.

THIS IS JUST A SELECTION OF OUR PRODUCTS. A LARGER RANGE IS AVAILABLE ELECTRONICALLY.



Warranty period for chairs, lounges and tables



Weight rating for individual chairs, lounges and tables*



Fully imported Chairs , lounges, tables, parts and components.



The Performance criteria adopted for certification by Furntech is based on Australian standards, e.g. Level 6 - Severe commercial and heavy industrial.*

**Weight limits are self-rated by Style Ergonomic Australia. AFRDI approved chairs are normally rated to 110kg.*



Furntech is an independent not-for-profit technical organisation providing standards, testing product certification and research for buyers and sellers of furniture.

AFRDI 142
Certification



AFRDI rating for multi shift use and 160kg weight limit.



BIFMA is a third-party certification program that provides manufacturers with valuable feedback for evaluating the environmental, human, and social impacts of their furniture products for manufacturing, facility, and organisation.

R1 TASK SEATING

PRESTIGE



P350



P350C



P350D

FEATURES

- » Adjustable seat height
- » Adjustable back height
- » Adjustable seat angle (with 3 lever mechanism only)
- » Adjustable back angle
- » Optional adjustable arms
- » Optional seat depth (seat slider) (not available on drafting chair)
- » Optional drafting kit
- » Optional 2 or 3 lever mechanism
- » Available in high and low back
- » Moulded seat and back foam
- » 600mm black nylon base
- » Available in local fabrics
- » AFRDI tested to level 6
- » Suitable for indoor use only
- » 7 year warranty
- » Weight limit is 130kg



P350H



P350HC

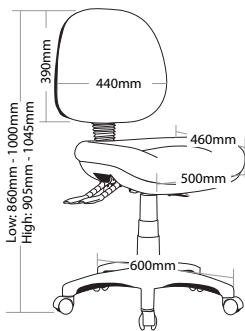

P350

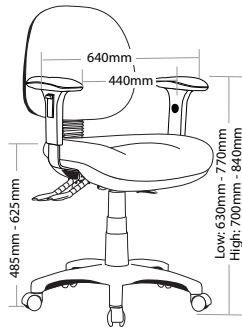

P350C

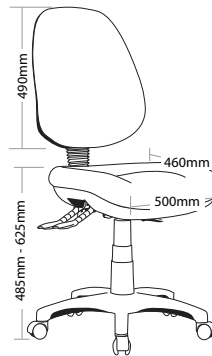

P350H

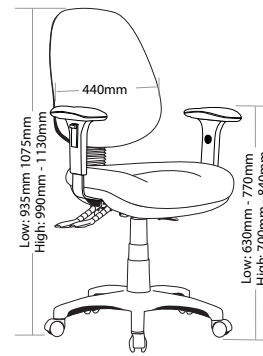

P350HC

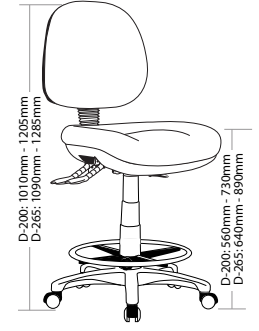

P350D

ECOTECH



E350



E350C



E350D

FEATURES

- » Adjustable seat height
- » Adjustable back height
- » Adjustable seat angle (with 3 lever mechanism only)
- » Adjustable back angle
- » Optional adjustable arms
- » Optional seat depth (seat slider) (not available on drafting chair)
- » Optional drafting kit
- » Optional 2 or 3 lever mechanism
- » Available in high and low back
- » Moulded seat and back foam
- » 600mm black nylon base
- » Available in local fabrics
- » AFRDI tested to level 6
- » Suitable for indoor use only
- » 7 year warranty
- » Weight limit is 130kg



E350H



P350HC

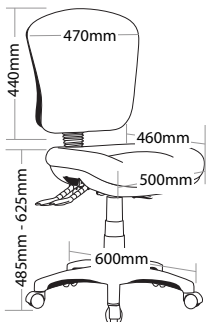

E350

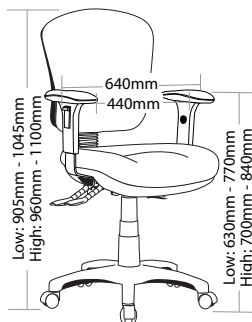

E350C

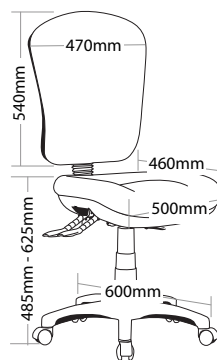

E350H

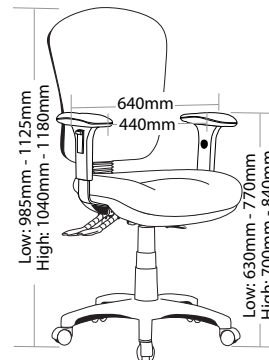

E350HC

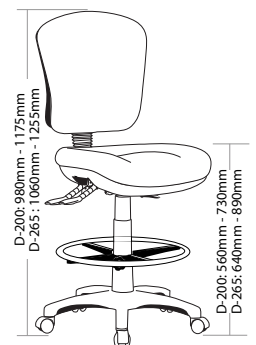

E350D

AVOCA



MAV350



MAV350C



MAV350D



MAV350H



MAV350HC

FEATURES

- » Adjustable seat height
- » Adjustable back height (ratchet)
- » Adjustable seat angle (with 3 lever mechanism only)
- » Adjustable back angle
- » Optional adjustable arms
- » Optional seat depth (seat slider) (not available on drafting chair)
- » Optional drafting kit
- » Optional 2 or 3 lever mechanism
- » Available in high and low back
- » Moulded seat foam
- » Mesh back
- » 600mm black nylon base
- » Available in local fabrics
- » Back mesh available in Jazz mesh
- » AFRDI tested to level 6
- » Suitable for indoor use only
- » 7 year warranty
- » Weight limit is 130kg

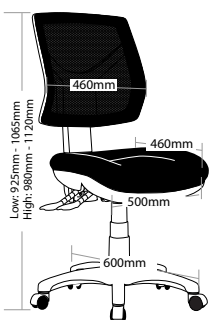

MAV350



MAV350C

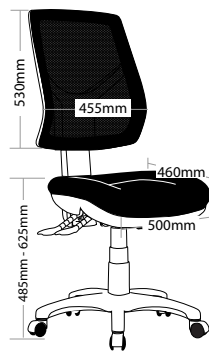

MAV350H

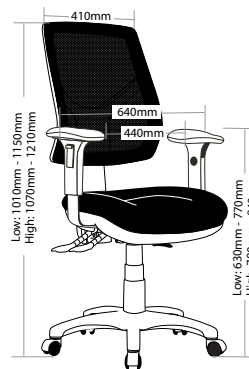

MAV350HC

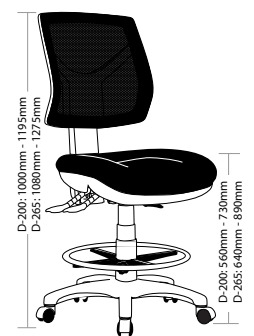

MAV350D

CHELSEA



MCH600L

MCH600LC

MCH600LD

FEATURES

- » Adjustable seat height
- » Adjustable back height (ratchet)
- » Adjustable back and seat angle
- » Adjustable weight tension
- » Optional adjustable arms
- » Optional seat depth (seat slider) (not available on drafting chair)
- » Optional drafting kit
- » Available in high and low back
- » Moulded seat foam
- » Mesh back
- » Big boy seat
- » 3 lever ergonomic heavy duty mechanism
- » 700mm black nylon base
- » Available in local fabrics
- » Back mesh available in Jazz mesh
- » AFRDI tested to level 6
- » Suitable for indoor use only
- » 7 year warranty
- » Weight limit is 140kg



MCH600H

MCH600HC

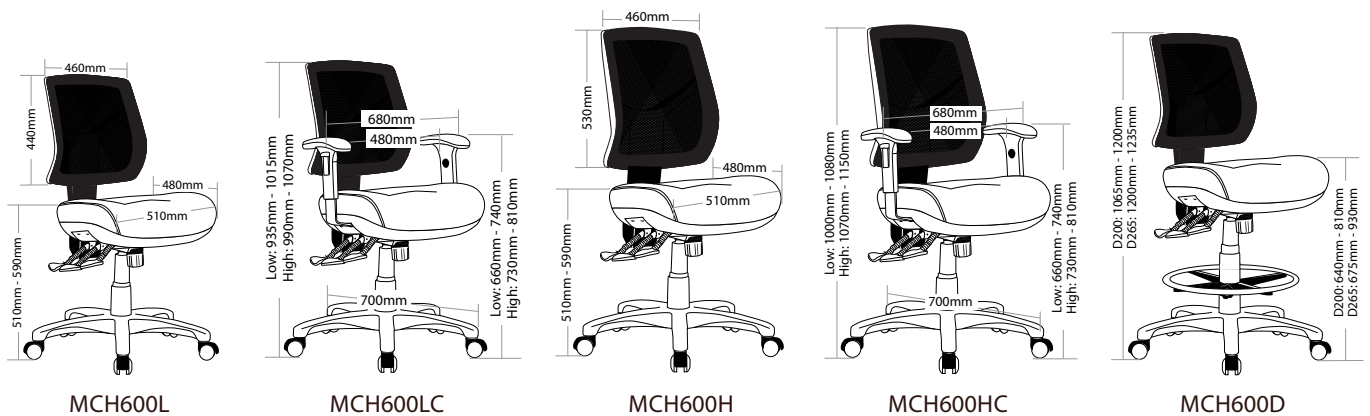

R2 MULTI SHIFT SEATING

ROTARY



FEATURES

- » Available in 2 seat widths
- » High density foam
- » Plastic under pan
- » Heavy duty black textured metal frame
- » Available in local fabrics
- » Optional frame or base colour (please allow 5 more days)
- » Suitable for indoor use only
- » 7 year warranty
- » Weight limit is 200kg



ROTARY-700

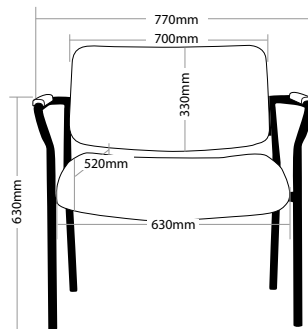

ROTARY-600

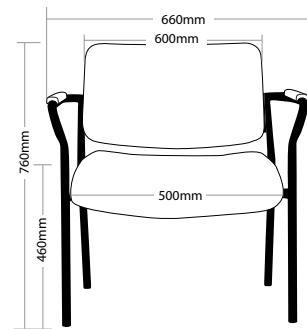

R3 EXECUTIVE SEATING

AUSTIN



FEATURES

- » Adjustable seat height
- » Adjustable seat and back angle
- » Adjustable weight tension
- » Adjustable arms
- » Available in high and low back
- » Plastic under pan
- » Moulded seat and back foam
- » Synchron mechanism with 3 locking positions
- » 700mm heavy duty black nylon base
- » Available in local fabrics
- » Suitable for indoor use only
- » 5 year warranty
- » Weight limit is 130kg



AUSTIN-H

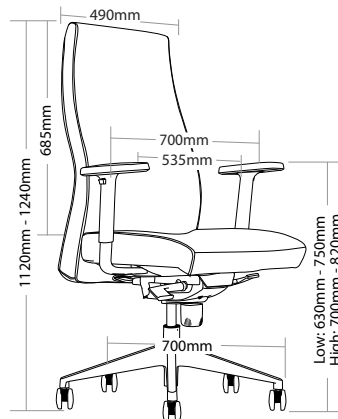

AUSTIN-L

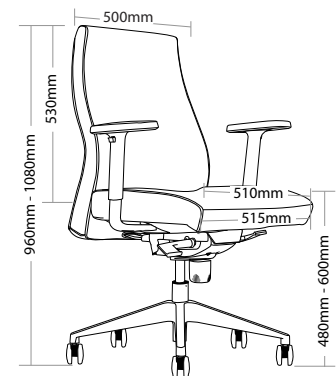

ACURA



ACURA-H/ACURA-L FEATURES

- » Adjustable seat height
- » Adjustable seat and back angle
- » Adjustable weight tension
- » Available in high and low back
- » Fixed aluminium arms
- » High density foam
- » Knee tilt mechanism with 3 locking positions
- » 700mm aluminium base
- » Available in local fabrics
- » Optional frame or base colour (please allow 5 more days)
- » Suitable for indoor use only
- » 5 year warranty
- » Weight limit is 120kg

ACURA-VC FEATURES

- » Chrome frame
- » High density foam
- » Available in local fabrics
- » Optional frame or base colour (please allow 5 more days)
- » Suitable for indoor use only
- » 5 year warranty
- » Weight limit is 120kg



ACURA-H



ACURA-L



ACURA-VC

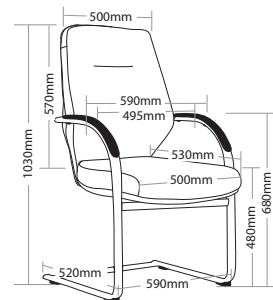
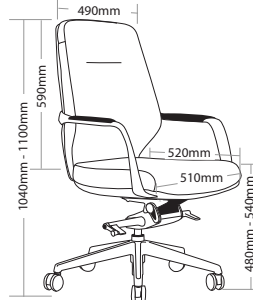
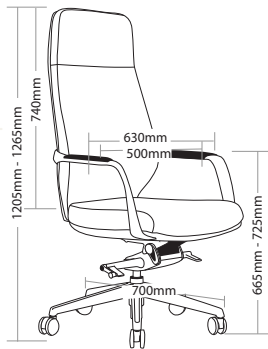

FOCUS



FEATURES

- » Optional arms
- » Optional left / right hand tablet arm
- » Optional black metal trolley, easy to move when stacked
- » Available in beam seating
- » Multi purpose stackable client chair
 - » Maximum 10 chairs on trolley
 - » Maximum 5 chairs on floor
 - » Maximum 3 chairs with arms
 - » Not stackable with tablet arms
- » Linkable except with tablet arms or arms
- » Fully strengthened plastic back shell
- » Fully welded frame
- » Sled chrome base
- » Available in all local fabrics
- » Optional frame or base colour (please allow 5 more days)
- » BIFMA drop tested
- » Suitable for indoor use only
- » 4 year warranty
- » Weight limit is 120kg



FOC-1U



FOC-1UA



FOC-TRL



FOC-1UTL



FOC-1UTR

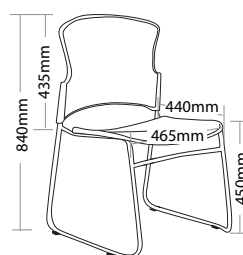
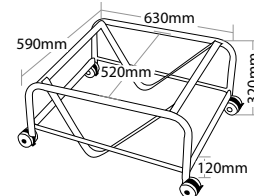

FOC-1U

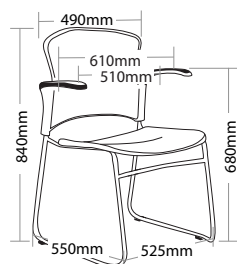

FOC-1UA

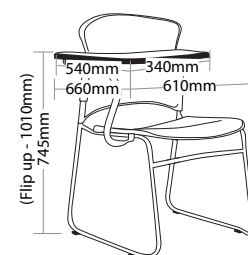

FOC-1UTR

POD



POD-B-NL



POD-RU-NL



POD-W-BL

FEATURES

- » Adjustable seat height with black base and black base with castors
- » Optional upholstered
- » Optional aluminium legs with timber or black finish
- » Optional black base
- » Optional black base with castor
- » Not stackable
- » Available in local fabrics
- » Available in black, red and white plastic shell
- » Optional frame or base colour (please allow 5 more days)
- » Suitable for indoor use only
- » 4 year warranty
- » Weight limit is 120kg



POD-BU-BL



POD-R-BB



POD-WU-BB

PLASTIC COLOUR



B-Black R-Red W-White



POD-B-BBC



POD-RU-BBC

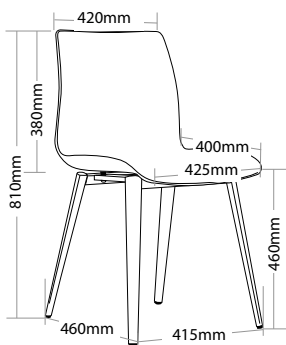

POD-NL

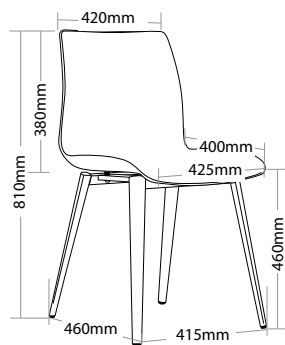

POD-BL

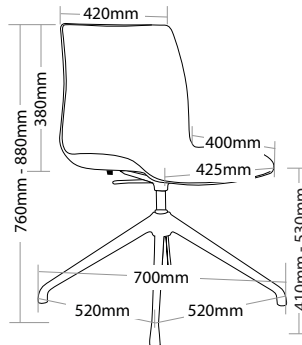

POD-BB

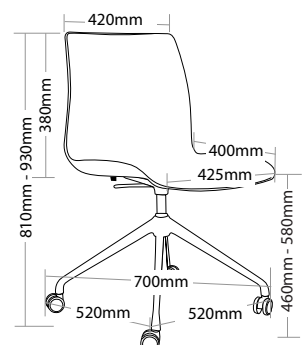

POD-BBC



POD 4 LEG



FEATURES

- » Optional arms
- » Optional tablet arm
- » Optional stool
- » Optional black metal trolley, easy to move when stacked
- » Optional 4 legs or sled base chrome frame
- » Available in beam seating
- » Stackable
 - » Maximum 10 chairs on trolley
 - » Maximum 5 chairs on floor
 - » Maximum 3 chairs with stools or arms
 - » Maximum 3 chairs with tablet arms
- » Plastic under pan
- » Available in local fabrics
- » Available in black, red and white plastic shell
- » Optional frame or base colour (please allow 5 more days)
- » Suitable for indoor use only
- » 4 Year warranty
- » Weight limit is 120kg



POD-4BU



POD-4RUA



POD-4WUT



POD-STBU

PLASTIC COLOUR



B-Black R-Red W-White

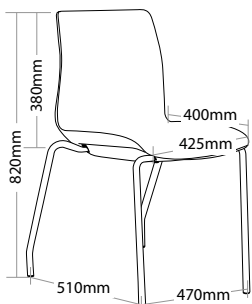

POD-4

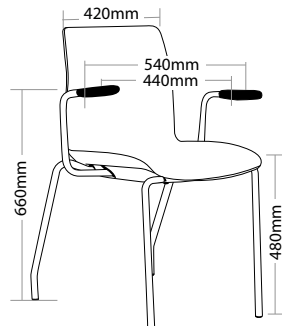

POD-4A

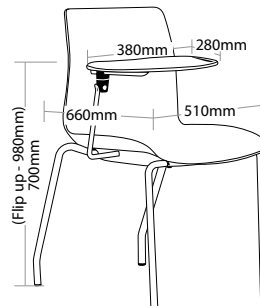

POD-4T

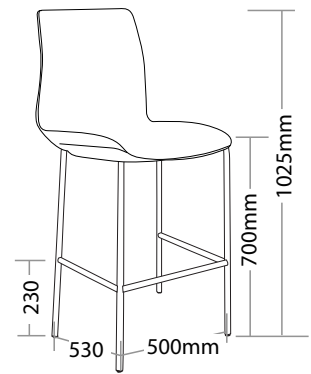

POD-ST



MAXI 4 LEGS



M1



M1-B



M1-C

FEATURES

- » Available with or without arms
- » Available in beam seating
- » Optional black or chrome finish
- » Optional upholstered or mesh back
- » Plastic under pan
- » Plastic outer back (upholstered back only)
- » 4 legs frame
- » Available in local fabrics
- » Back mesh available in Jazz mesh
- » Optional frame or base colour (please allow 5 more days)
- » AFRDI approved to level 6
- » Suitable for indoor use only
- » 5 year warranty
- » Weight limit is 120kg



MM1



MM1-B



MM1-C



M1-BC



MM1-BC

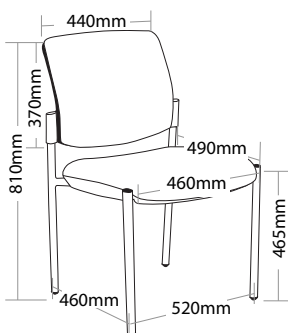

M1

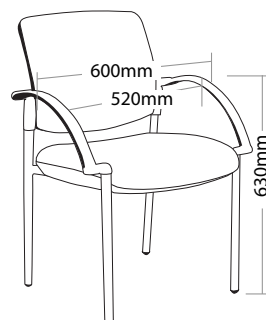

M1-B

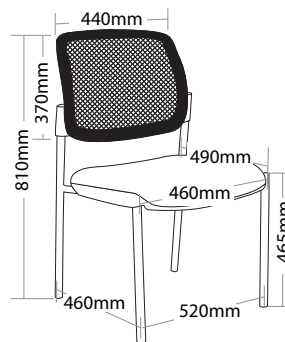

MM1

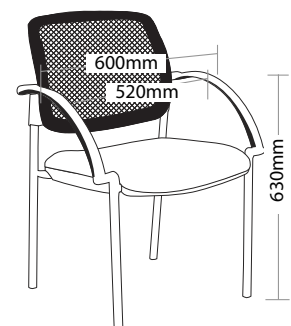

MM1-B

R5 BEAM SEATING

FOCUS



WEIGHT LIMIT
200
Kilogram



F-BEAM 2U

FEATURES

- » Optional 2 or 3 seater
- » Fully welded black metal frame
- » Twin seat support bars
- » Adjustable feet
- » Available in local fabrics
- » Suitable for indoor use
- » 4 year warranty
- » Weight limit for 2 seater is 200kg
- » Weight limit for 3 seater is 300kg

WEIGHT LIMIT
300
Kilogram



F-BEAM 3U

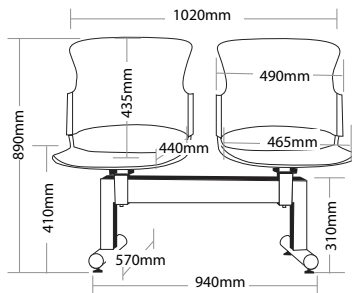

F-BEAM 2

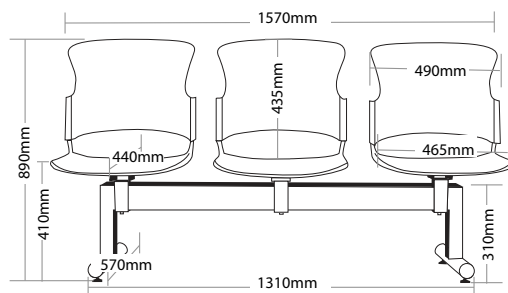

F-BEAM 3

VINN

WARRANTY 4 Year	WEIGHT LIMIT 180 Kilogram	WEIGHT LIMIT 250 Kilogram	WEIGHT LIMIT 300 Kilogram	UPHOLSTERED IN AUSTRALIA
-------------------------------------	---	---	---	------------------------------------

FEATURES

- » Optional 2, 3 or 4 seater
- » Optional plastic or mesh back
- » Heavy duty black metal beam frame
- » Black plastic
- » Adjustable feet
- » Available in local fabrics
- » Back mesh available in Jazz fabric
- » Suitable for indoor use
- » 4 year warranty
- » Weight limit for 2 seater is 180kg
- » Weight limit for 3 seater is 250kg
- » Weight limit for 4 seater is 300kg



V-BEAM 2



V-BEAM 2M

WEIGHT LIMIT
180
Kilogram



V-BEAM 3



V-BEAM 3M

WEIGHT LIMIT
250
Kilogram



V-BEAM 4



V-BEAM 4M

WEIGHT LIMIT
300
Kilogram

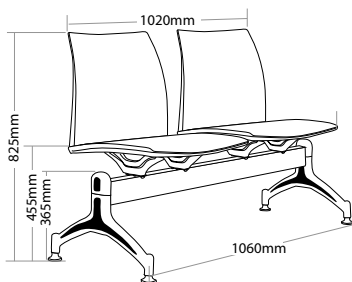

V-BEAM 2

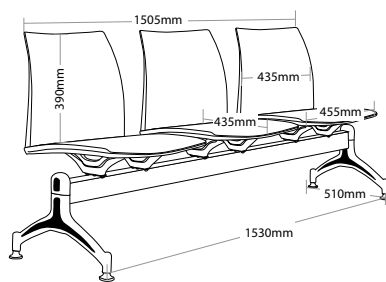

V-BEAM 3

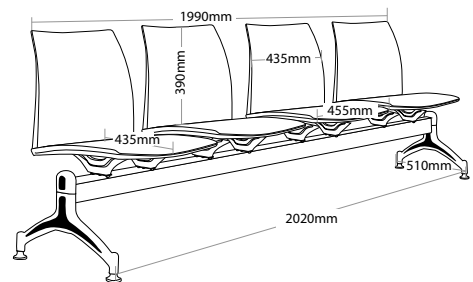

V-BEAM 4

R5 BEAM SEATING



POD

WARRANTY 4 Year	WEIGHT LIMIT 200 Kilogram	WEIGHT LIMIT 300 Kilogram	WEIGHT LIMIT 350 Kilogram	UPHOLSTERED IN AUSTRALIA
-------------------------------------	---	---	---	---------------------------------

FEATURES

- » Optional 2, 3 or 4 seater
- » Heavy duty black metal beam frame
- » Adjustable feet
- » Available in local fabrics
- » Available in black, red and white plastic only
- » Suitable for indoor use
- » 4 Year warranty
- » Weight limit for 2 seater is 200kg
- » Weight limit for 3 seater is 300kg
- » Weight limit for 4 seater is 350kg

PLASTIC COLOUR

	B-Black		R-Red		W-White
---	---------	---	-------	---	---------

WEIGHT LIMIT
200
Kilogram



P-BEAM 2BU

WEIGHT LIMIT
300
Kilogram



P-BEAM 3RU

WEIGHT LIMIT
350
Kilogram



P-BEAM 4WU

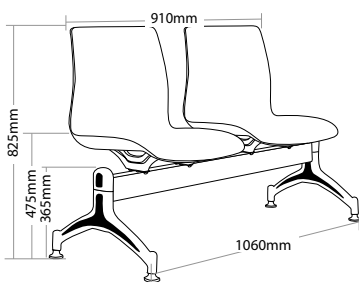

P-BEAM 2

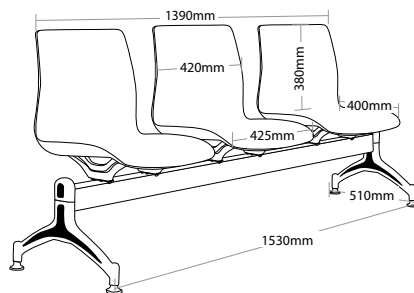

P-BEAM 3

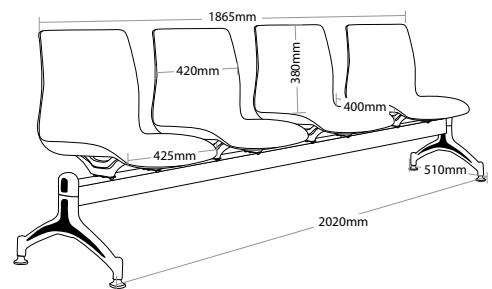

P-BEAM 4

VERO



FEATURES

- » Optional black or timber finish
- » Plywood inner structure
- » High density foam
- » Steel frame
- » Available in local fabrics
- » Optional frame or base colour (please allow 5 more days)
- » Suitable for indoor use only
- » 5 year warranty
- » Weight limit is 130kg



VERO-STB



VERO-STT



VERO-CHB



VERO-CHT

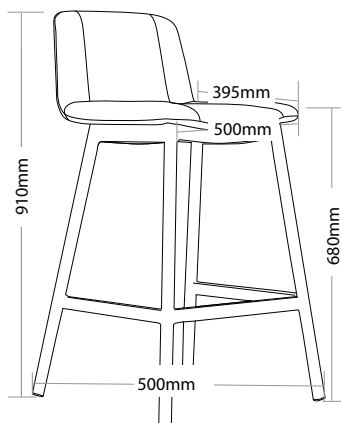

VERO-ST

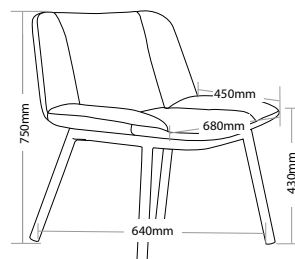

VERO-CH

R6 BREAKOUT SEATING



GOLD



GOLD-4L



GOLD-SB



GOLD-AB



GOLD-NL



GOLD-BL



GOLD-BB



GOLD-BBC

FEATURES

- » Adjustable seat height with 4 star base, black base and black base with castors
- » Optional chrome sled base
- » Optional chrome 4 leg frame
- » Optional 700mm aluminium 4 star base
- » Optional timber legs with natural finish
- » Optional timber legs with black finish
- » Optional black base with or without castors
- » High density foam
- » Plywood shell
- » Available in local fabrics
- » Optional frame or base colour (please allow 5 more days)
- » Suitable for indoor use only
- » 5 year warranty
- » Weight limit is 130kg

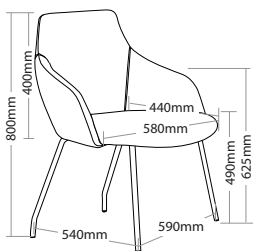

GOLD-4L

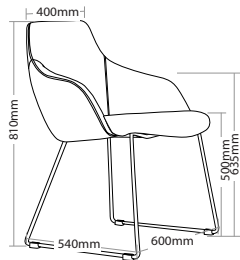

GOLD-SB

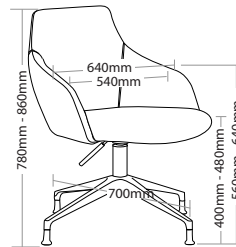

GOLD-AB

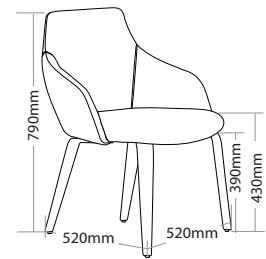

GOLD-BL

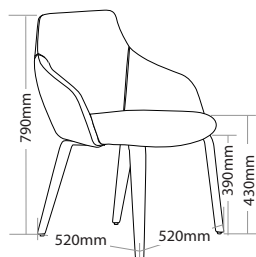

GOLD-NL

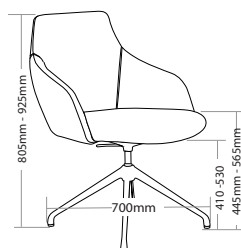

GOLD-BB

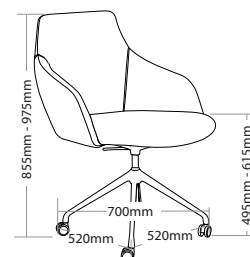

GOLD-BBC

R6 BREAKOUT SEATING

JUNE



FEATURES

- » Adjustable seat height
- » High density foam
- » 700mm aluminium 4 star base
- » Plywood shell
- » Available in local fabrics
- » Optional frame or base colour (please allow 5 more days)
- » Suitable for indoor use
- » 5 Year warranty
- » Weight limit is 120kg



JUNE



SIDE VIEW

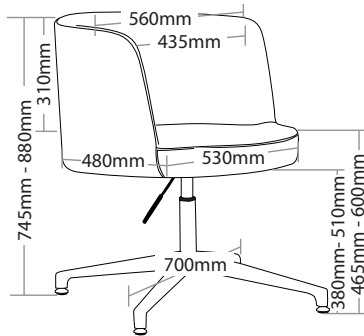

OPERA



FEATURES

- » Optional timber legs
- » Optional 700mm high arch aluminium 4 star base
- » Optional chrome 4 leg frame
- » Loose back and seat cushions
- » Moulded foam on steel frame
- » Available in local fabrics
- » Optional frame or base colour (please allow 5 more days)
- » Suitable for indoor use only
- » 5 year warranty
- » Weight limit is 120kg



OPERA-4L



OPERA-TL



OPERA-AB

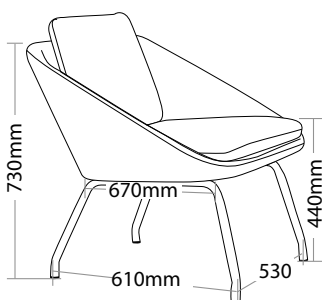

OPERA-4L

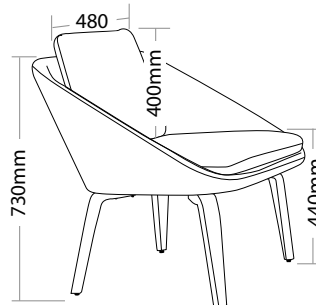

OPERA-TL

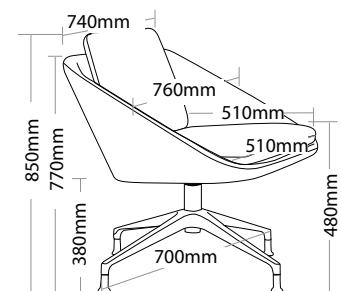

OPERA-AB

TIME



FEATURES

- » Adjustable seat height with black base and black base with castors
- » Optional solid rod base sled chrome frame
- » Optional timber legs with natural finish
- » Optional timber legs with black finish
- » Optional black base with or without castors
- » High density foam
- » Moulded back foam
- » Plywood shell
- » Available in local fabrics
- » Optional frame or base colour (please allow 5 more days)
- » Suitable for indoor use only
- » 5 year warranty
- » Weight limit is 120kg



TIME



TIME-NL



TIME-BL



TIME-BB



TIME-BBC

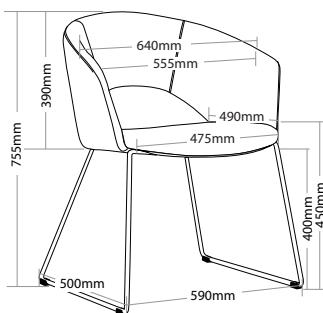

TIME

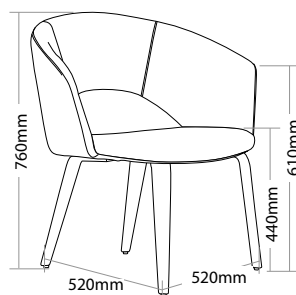

TIME-BL/NL

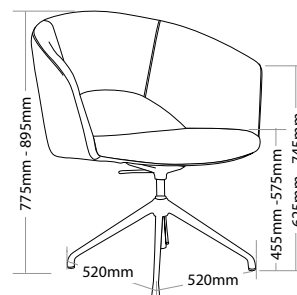

TIME-BB

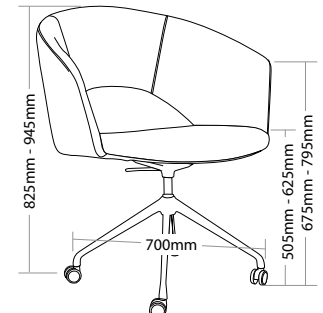

TIME-BBC

LEAF



FEATURES

LEAF-L/LEAF-H FEATURES

- » Available in high and low back
- » High density foam
- » Loose back cushion
- » Metal frame
- » Adjustable feet
- » Available in local fabrics
- » Suitable for indoor use only
- » 3 year warranty
- » Weight limit is 120kg

TABLE FEATURES

- » MDF white top
- » Chrome frame
- » 3 year warranty



LEAF-L

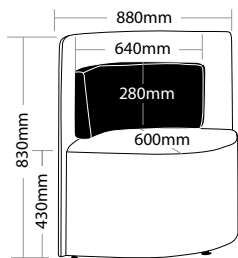

LEAF-L



LEAF-H

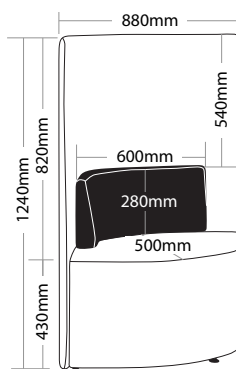

LEAF-H



LEAF-T

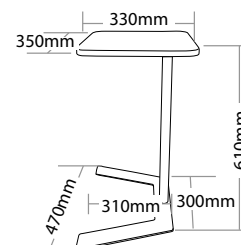

LEAF-T

PLAY



FEATURES

- » Available in 2 options only
- » High density foam
- » Solid timber frame
- » Plastic legs
- » Available in local fabrics
- » Suitable for indoor use only
- » 3 year warranty
- » Weight limit is 120kg



PLAY-1



PLAY-2

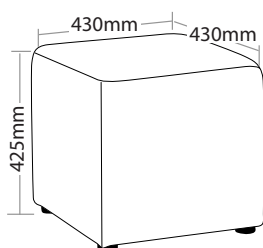

PLAY-1

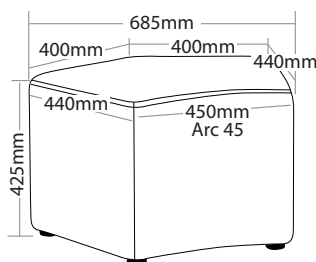

PLAY-2



GROUP

R7 OTTOMANS

OLA



FEATURES

- » Available in triangle, round and square shape
- » High density foam
- » Solid timber frame
- » Plastic legs
- » Available in local fabrics
- » Suitable for indoor use only
- » 3 year warranty
- » Weight limit is 120kg



OLA-T

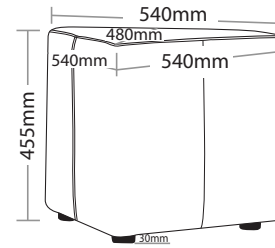

OLA-R

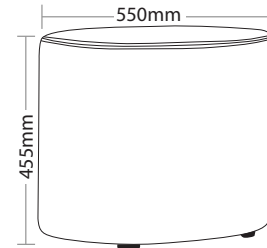

OLA-S

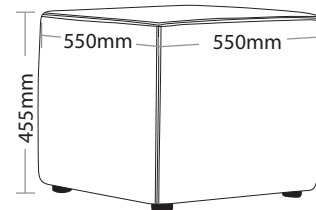

CLIP



FEATURES

- » Zig zag steel spring
- » Solid hardwood frame
- » Webbed base
- » Chrome legs
- » Available in local fabrics
- » Optional frame or base colour (please allow 5 more days)
- » Suitable for indoor use only
- » 3 year warranty
- » Weight limit is 130kg



CLIP

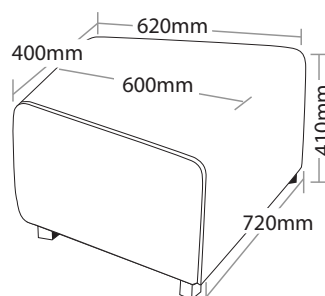

GROUP

IMPRESS



FEATURES

IMPRESS FEATURES

- » Available in 2 options only
- » Moulded polyurethane foam
- » Solid hardwood frame
- » Zinc legs
- » Available in local fabrics
- » Optional frame or base colour (please allow 5 more days)
- » Suitable for indoor use only
- » 3 year warranty
- » Weight limit is 130kg

IMPRESS TABLE FEATURES

- » 8mm Tempered glass top
- » Chrome legs
- » Optional frame or base colour (please allow 5 more days)
- » Suitable for indoor use only
- » 3 year warranty



IMPRESS-1

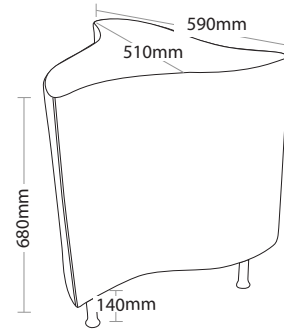

IMPRESS-2

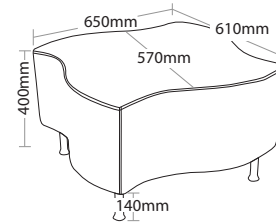

IMPRESS-T

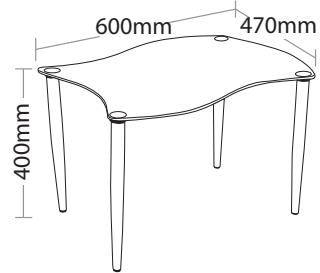

RADIUS



FEATURES

- » Available in 2 options only
- » Moulded polyurethane foam
- » Zinc legs
- » Available in local fabrics
- » Optional frame or base colour (please allow 5 more days)
- » Suitable for indoor use only
- » 3 year warranty
- » Weight limit is 130kg



RADIUS-1

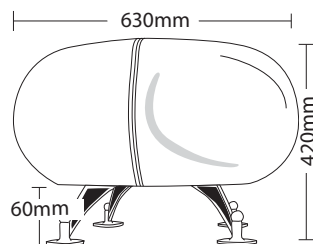

RADIUS-2

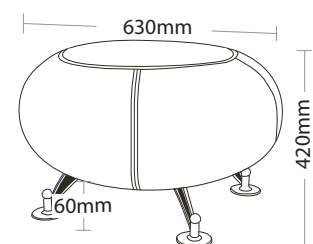

**GAMMA, LIFT,
VEGAS AND FLOW**



GAMMA



VEGAS

FEATURES

GAMMA/VEGAS FEATURES

- » Solid rod chrome frame
- » Available in local fabrics
- » Optional frame or base colour (please allow 5 more days)
- » Suitable for indoor use only
- » 4 year warranty
- » Weight limit is 120kg

LIFT/ FLOW FEATURES

- » Adjustable seat height
- » Solid steel stain base
- » Foot rest
- » Available in local fabrics
- » Suitable for indoor use only
- » 4 year warranty
- » Weight limit is 120kg



LIFT



FLOW

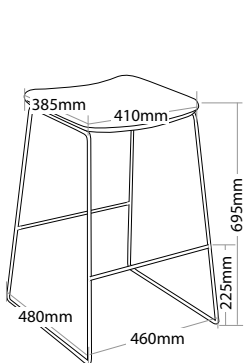

GAMMA

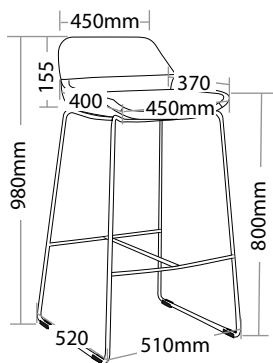

VEGAS

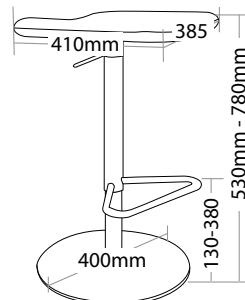

LIFT

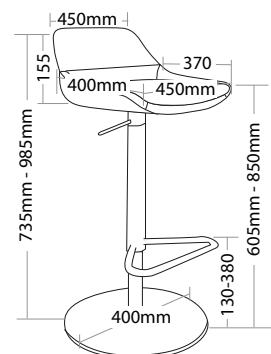

FLOW

BLITZ



FEATURES

- » High density foam
- » Zig zag steel spring
- » Plywood frame
- » Chrome feet
- » Available in local fabrics
- » Optional frame or base colour (please allow 5 more days)
- » Suitable for indoor use only
- » 5 year warranty
- » Weight limit is 120kg



BLITZ-U

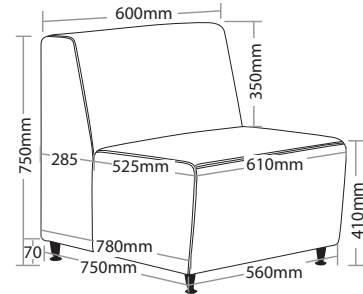

TWIST



FEATURES

- » Available in 3 options only
- » High density foam
- » Plywood frame
- » Webbed base
- » Chrome feet
- » Available in local fabrics
- » Optional frame or base colour (please allow 5 more days)
- » Suitable for indoor use only
- » 3 year warranty
- » Weight limit is 120kg



TWIST-SI



TWIST-SO



GROUP



TWIST-OT

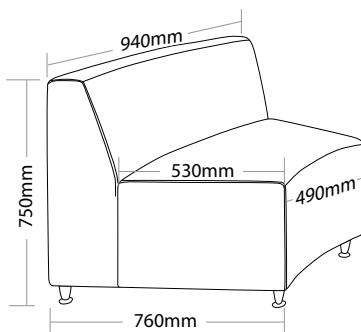

TWIST-SI

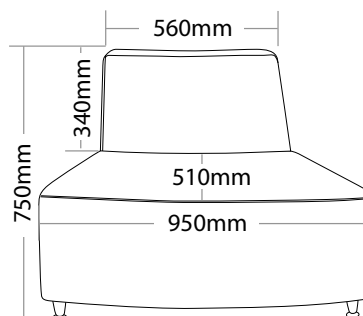

TWIST-SO

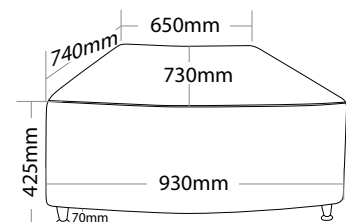

TWIST-OT

R9 SOFT SEATING



ROXA



WEIGHT LIMIT
130
Kilogram

ROXA-1



WEIGHT LIMIT
260
Kilogram

ROXA-2

FEATURES

- » Optional 1 or 2 seater
- » High density foam
- » Solid hardwood frame
- » Zinc legs
- » Available in local fabrics
- » Suitable for indoor use
- » 5 year warranty
- » Weight limit for 1 seater is 130kg
- » Weight limit for 2 seater is 260kg

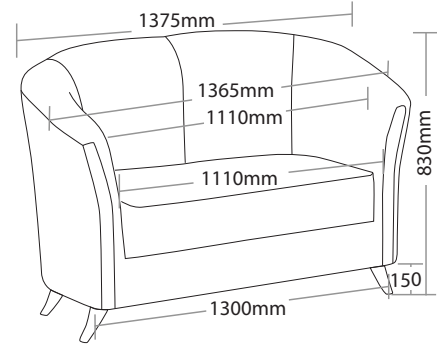
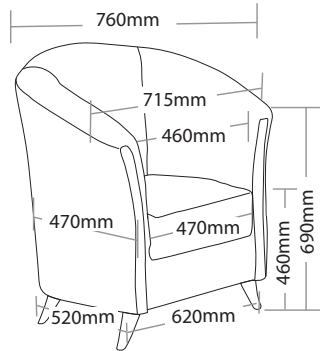

MONTAGE



FEATURES

- » Optional 1, 2 or 3 seater
- » Pocket spring seat
- » Loose cushions upholstered both sides
- » Zig zag steel spring
- » Webbed base
- » Solid hardwood frame
- » Stainless steel feet
- » Available in all local fabrics
- » Optional frame or base colour (please allow 5 more days)
- » Suitable for indoor use
- » 5 year warranty
- » Weight limit for 1 seater is 130kg
- » Weight limit for 2 seater is 260kg
- » Weight limit for 3 seater is 390kg



WEIGHT LIMIT
130
Kilogram

MO-1S

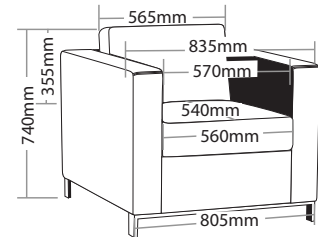

WEIGHT LIMIT
260
Kilogram

MO-2S

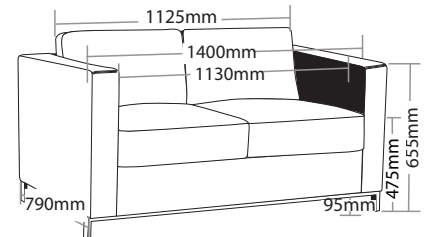

WEIGHT LIMIT
390
Kilogram

MO-3S

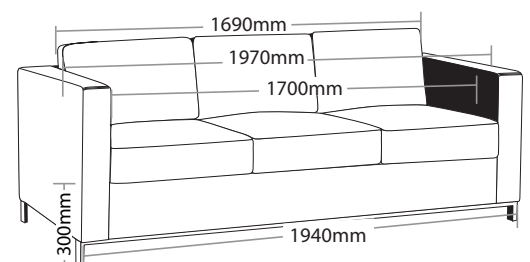

SHELL



FEATURES

- » Australian made
- » Available in 1 or 2 seater (custom size available, please contact office)
- » High density foam
- » Loose cushions upholstered both sides
- » Timber frame
- » Aluminium legs
- » Available in local fabrics (two tone available, please contact office)
- » Optional frame or base colour (please allow 5 more days)
- » Suitable for indoor use
- » 5 year warranty
- » Weight limit for 1 seater is 130kg
- » Weight limit for 2 seater is 260kg



SHELL-1S



SHELL-2S



SHELL-1SH



SHELL-2SH

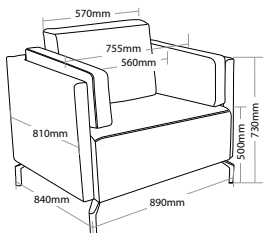

SHELL-1S

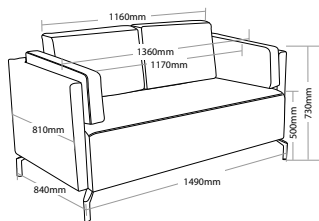

SHELL-2S

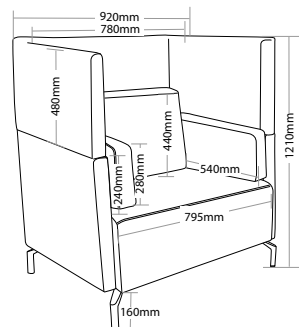

SHELL-1SH

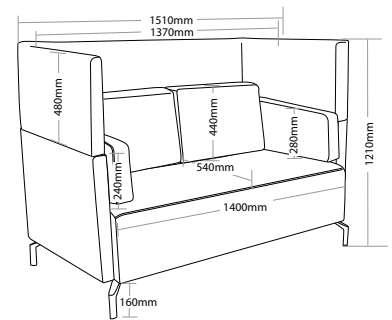

SHELL-2SH

ACOUSTIC SCREENS



FEATURES

- » Solid timber frame
- » Frames wrapped with a 10mm layer of foam
- » Frames wrapped with a layer of cardboard
- » 19mm metal side frame
- » Australian made
- » Optional frame or base colour (please allow 5 more days)
- » Suitable for indoor use
- » 2 year warranty

OPTIONS

CODE	MTR	SCREEN SIZE (HXW)	COVERD IN TRILOGY FABRIC
FAS-1212	3.0	1200x1200mm	\$254.00
FAS-1215	3.0	1200x1500mm	\$273.00
FAS-1218	3.0	1200x1800mm	\$286.00
FAS-1512	3.0	1500x1200mm	\$254.00
FAS-1515	3.0	1500x1500mm	\$266.00
FAS-1518	3.0	1500x1800mm	\$292.00
FAS-1812	4.0	1800x1200mm	\$317.00
FAS-1815	4.0	1800x1500mm	\$337.00
FAS-1818	4.0	1800x1800mm	\$349.00

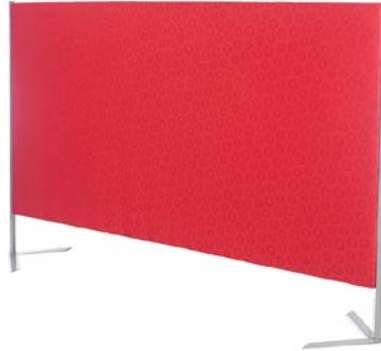

FAS-1218

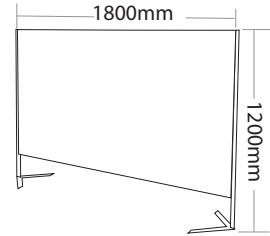

FAS-1518

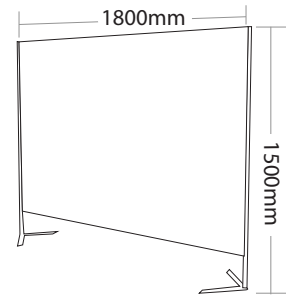

FAS-1818

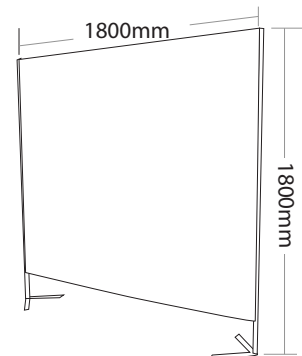

STATE



FEATURES

- » Adjustable seat height
- » Optional drafting kit
- » Optional glides or brake castors
- » 600mm black nylon base
- » Available in local fabrics
- » Suitable for indoor use
- » 5 year warranty
- » Weight limit is 120kg



ST003



ST003D

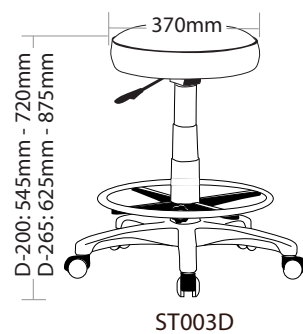
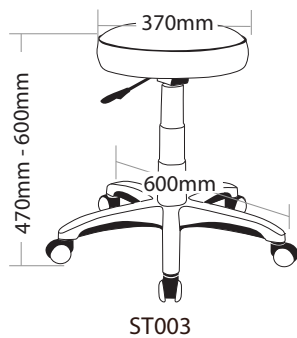





BLINDS & CURTAINS

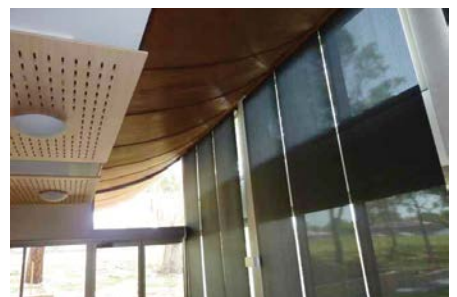

Roller Blinds

With an extensive range of fabric and colour choices, roller blinds offer you a versatile solution for your window furnishing requirements.

Available in blockout, light filtering, sunscreen or a combination of both – one for day, one for night. With chain drive, linked, twin, spring assist and motorisation, roller blinds offer an affordable, practical and versatile window covering solution.



Options:



Twin Systems



Chain Drive



Motorised



Remote control

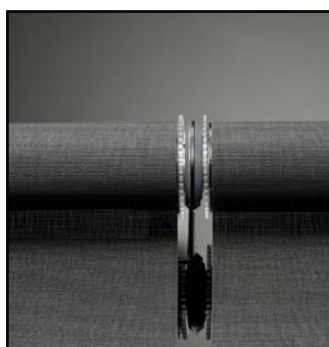

Easy Link System



Automate Blind



Blackout System



Parts & Accessories

Vertical Blinds

With an affordable price tag, privacy and light are easily controlled. The slats stack neatly open allowing maximum viewing capacity. Vertical Blinds are available in a range of slat sizes and come with the option of centre open or side bunch.



Venetian Blinds

Venetian Blinds are available in cedar, basswood, timber look or aluminium with a range of slat sizes and colours. Offering practical light regulation and privacy control they can be fully raised or the blade angle adjusted to suit.

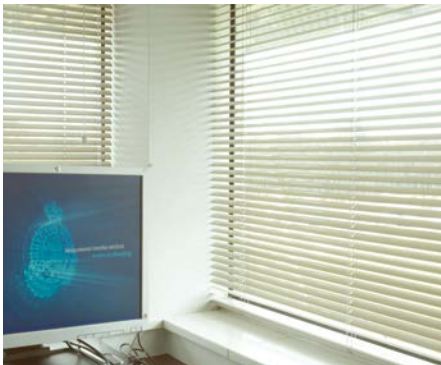

Panel Glides

Designed as a modern alternative to vertical blinds, panels move through multiple tracking channels with the use of a smooth operating wand that eliminates the need for chains and safety devices and enhances the sleek elegance of this simplistic blind. They can be opened to the left, right or centre making them the ideal covering for sliding doors and large windows. When open the panels stack neatly back behind each other. Fabric can be matched with roller or roman blinds to create a consistent decor throughout.



Roman Blinds

Roman Blinds combine the simplicity of blinds with the warmth of soft furnishing fabrics. A perfect stand alone blind, or together with curtains in the same or contrasting fabric. Roman Blinds have a classic and timeless look and are available in both blind fabrics and curtain fabrics.



Pleated Blinds

Pleated Blinds combine the soft appeal of a curtain with the versatility and simplicity of a blind. Pleated Blinds almost disappear when raised and minimal light gaps help to reduce glare. Available as a twin blind they are practical for day and night use. Select a sheer fabric to enjoy the view as well as a blockout fabric for privacy at night. Available in many colours, pleated blinds can become a striking feature lifting the mood and character of any room.

Pleated Blinds present the most versatile solution for unusual shaped windows from triangles to circles, skylights and conservatories no situation is too challenging.



FOR A MORE COMPREHENSIVE PRODUCT RANGE
Visit our website at www.quicksew.com.au





Double Pinch Pleat



Triple Pinch Pleat



Inverted Pleat

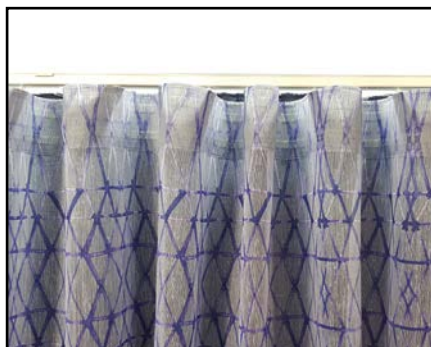

S Wave



Pencil Pleat



Goblet Pleat



Eyelet



Knife Pleat



Trimmings



Swags & Tails



Banana Tiebacks



Tassel Tiebacks

Company Profile

From concept, through to design and completion, Quicksew provides high quality, beautiful, functional furniture and soft furnishings for your project, on time and within budget.

About Quicksew

Quicksew was established in 1977 by the White family as a soft furnishings manufacturer and has since developed into a nationwide concept, design and installation specialist of furniture and soft furnishings for a range of industry sectors including:

- Health and Aged Care:
- Commercial and Building:
- Educational; and
- Hospitality sectors.

In the 40 years of trading, we have gained industry knowledge and experience that we share with key decision makers and industry stakeholders through personal consultations, trade shows and exhibitions.

Our dedicated Sales & Marketing Team and Operations Team offer professional and informative concepts, design solutions, manufacture, and delivery from single item products to complete design and fit-out of furniture, window treatments, fittings and soft furnishings for new builds, renovations and refurbishments. We work within the customer's time and budget constraints to deliver products and service of the highest quality and excellence.

Our focus on providing excellent service is driven by our commitment to working with new and existing customers to help them create beautiful and functional spaces to enhance the experience of the individuals who use them.

Location and Service Area.

With the Quicksew head office and factory located in Bathurst in the Central West of NSW, our service provision extends to Queensland, NSW, ACT, Victoria and beyond. Our Sales Team will travel anywhere in Australia to introduce our business and work with customers. We arrange personal visits to ensure that we gain the best possible background knowledge to create a design concept that is unique. We do not just supply, deliver and install products, we help our customers make appropriate and practical choices. Our service is customised to meet individual needs and requirements using the latest design trends, textiles and products to create beautiful functional environments that are safe, aesthetically pleasing and financially viable.



Mission Statement

"To maintain our position as a leading manufacturer of curtains, blinds and soft furnishings, concept creator and supplier by continually enhancing and updating our product range and level of service to provide customers with unique and functional spaces."

To help us achieve our mission statement, we aim to:

- Provide the latest product information and technology
- Create schemes that are aesthetically pleasing yet functional that work within the customer's budget
- Manufacture curtains, blinds and soft furnishings of exceptional quality and finish
- Support Australian made furniture manufacturers as a priority
- Source and supply only the finest quality furniture that is durable, stylish and comfortable using resilient fabrics of the latest design
- Work within an Integrated Management System framework as a commitment to the International Standards for Quality Management ISO 9001:2015; Environmental Management ISO 14001:2015; and AS/NZS 4801:2001 Australian/New Zealand Occupational Health & Safety.

Continual research to find new suppliers and the latest advancements in products ensures that Quicksew is a leading supplier of furniture and soft furnishings. Constant contact with suppliers keeps us up to date with any advancements in product technology, performance and manufacturing.

Consultation, Supply and Installation Process

Quicksew is committed to building great relationships and offering personal attention to new and existing customers. The following procedure outlines the Quicksew process from initial customer contact to delivery and installation of product.

Step 1. Initial contact

Customers can contact Quicksew in person by visiting our Head Office Showroom in Bathurst or by telephone, email or via our website - www.quicksew.com.au. Our sales and marketing team actively seek out new and existing customers through email, telephone and personal contact.

Step 2. Introduction to Quicksew services and site consultation

A Quicksew representative arranges an appointment to meet with the prospective client to introduce our products and services utilising our catalogue, product samples and website. They will engage in discussion about site specifications, budget and any initial customer design ideas. We listen to the customer's requirements and needs so that we may supply the best product options that are fit for purpose.

Step 3. Sharing of information - Site plans, schedules and timeframe

Information is shared in person, online, via telephone, video conferencing and through emails. The customer will be asked for all available information about the site including plans/drawings, schedules/design brief or specifications and the timeframe for works completion.

Step 4. Estimating & quoting - quantifying & preliminary pricing

Based on the design brief, our estimating staff quantify products and fabrics and work out a preliminary quote that best reflects the customer's needs within budget. This is taken back to the customer for discussion and approval.

Step 5. Design concept & colour boards

Our design team put together colour and design concepts that reflect the look & feel that the customer is trying to achieve. Fabrics and products are showcased on colour boards as a visual representation of the initial quote. During the presentation, we seek feedback from the customer and offer alternatives and solutions before a decision is made.

Step 6. Final quote & customer commitment – Letter of Intent/Purchase Order

Once the final colour, fabric and product selections have been made, the final quote is sent to the customer for approval and supply timeframes discussed again. The customer then accepts the quote and commits to the sale.

Step 7. Handover to production

Upon receipt of either a letter of intent or purchase order, the quote is handed over to the Operations Department where it is entered as a sale and a deposit invoice raised and sent to the customer. The Operations Manager will contact the customer to arrange a final check measure. The project timeframe, site access and currency of plans will be discussed with the customer at this point.

Step 8. Ordering & manufacturing

Once the deposit has been received, the quoted products are ordered and manufactured. The customer will be notified if there are any supply issues regarding fabrics or product and if necessary, an alternative product offered. During the manufacturing and receipt of goods, all products are inspected for quality assurance to make sure they meet specifications. Furniture is stored at Quicksew's freight facility until all items on the quote are complete and ready for delivery.

Step 9. Delivery & installation

The Operations Manager will contact the site to arrange a suitable and convenient time for installation of window treatments and the delivery of furniture. Please note that the extent of furniture placement is dependent upon the initial agreement during consultation and acceptance of the quote terms and conditions.

Company Details

Company/trading name:	Parklane Interiors Australia Pty trading as Quicksew
ABN:	63 087 618 639
Date of company formation:	1977
Number of employees:	16 full-time staff and 4 casuals
Address:	16 Bradwardine Rd Bathurst NSW 2795
Contact details	Jonathan White Managing Director 16 Bradwardine Rd Bathurst NSW 2795 Phone: 02 6332 2144 Email: jwhite@quicksew.com.au
Liability status:	Proprietary Company
Details of owner:	Jonathan & Margaret White
Accountancy representation:	Pigot Miller Wilson Accountants and Advisors

Core Competencies & Organisational Achievements

To ensure ongoing quality of service and products, Quicksew implements an Integrated Management System and has achieved Best Practice certification for compliance with the three major International Standards for quality, safety and the environment.

ISO 9001:2015 – Quality Management System

ISO 4801:2001 – OH&S Management System

ISO 14001:2015 – Environmental Management System



Statements of Certification for each Standard included herein.

ISO Standards

The International Organisation for Standardisation (ISO) is an international standard-setting body composed of representatives from various national standards organisation. ISO International Standards ensure that products and services are safe, reliable and of good quality. For business, they are strategic tools that reduce cost by minimising waste and errors and increasing productivity.

By doing this, we have made a commitment that our company adheres to the requirements of the standards and takes into account

- the Quality Assurance and Management of business operations;
- the Environmental Aspects of the business to ensure we minimise or eliminate potential environmental impacts whilst maximising improvement and efficiency in the workplace; and
- the WHS hazards of the business to ensure we minimise or eliminate potential workplace injury and illness whilst maximising improvement and efficiency in the workplace.

NSW Government Accredited Supplier

Quicksew is an approved supplier for NSW Government institutions and facilities through their NSWBuy Portal.



Personnel Profile

<p>Jonathan White Managing Director</p> <p>Margaret White Executive Secretary</p>	<p>Present owner and operator, Jonathan White has been Managing Director since 2000 when he bought the business from his brother. He and his wife Margaret, have built the business from a small manufacturer for the domestic and commercial market, to a leading manufacturer and supplier of curtains, blinds, furniture and accessories for hospitals, aged care facilities, schools, large scale commercial projects and hotel/motels.</p> <p>It is Jonathan's understanding of, and expertise in the industry that has driven the growth of the business.</p>
<p>Gaylene Anderson Operations Manager</p>	<p>Gaylene joined the Quicksew team in February 2015. Her experience in project management and site knowledge ensures high levels of management and involvement in all operational aspects of the business.</p>
<p>Reception</p>	<p>Inward correspondence whether by telephone or email is directed through reception. Enquiries and business is directed to the relevant staff member for action or follow up.</p>
<p>Sales, Marketing & Estimating Team 8 staff members Residential Commercial Health and Ageing</p>	<p>The Quicksew Sales Team continuously engage all stakeholders in meaningful consultation and communication about the latest technology and developments in products, design solutions and manufacturing. They work with the customer to provide information about single item products or the complete design and fit-out of furniture, window treatments, fittings and soft furnishings for new builds, renovations and refurbishments. Our sales team work within the customer's specifications, time and budget constraints to supply products and service of the highest quality and excellence.</p> <p>Their focus is to build and maintain relationships with key people including Head Office contacts, Architects, Facility Managers and Procurement Officers.</p> <p>Utilising their knowledge of product and fabrics, the Estimating Team correlates the information gathered through consultation with the customer and Sales Team to work out the costs of supply and installation.</p> <p>All prospective customers receive a detailed quote which is emailed, posted or hand delivered depending on the customer's expectations and requirements.</p>
<p>Operations and Production 9 staff members</p>	<p>Operations and Production Staff are responsible for the purchasing, ordering of raw materials, manufacturing, delivery and installation of customer orders.</p> <p>Working within Quicksew's Quality Management System ensures that products are manufactured, supplied and delivered to specification and of the finest quality and standard.</p> <p>Customer liaison is key to successful completion of projects and all communication is directed through the Operations Manager.</p>
<p>Installation Team</p>	<p>Supervised by the Operations Manager, products are installed by experienced and capable technicians and tested on site. Upon completion of installation, products are signed for by the customer.</p>

Quicksew
Organisation Chart

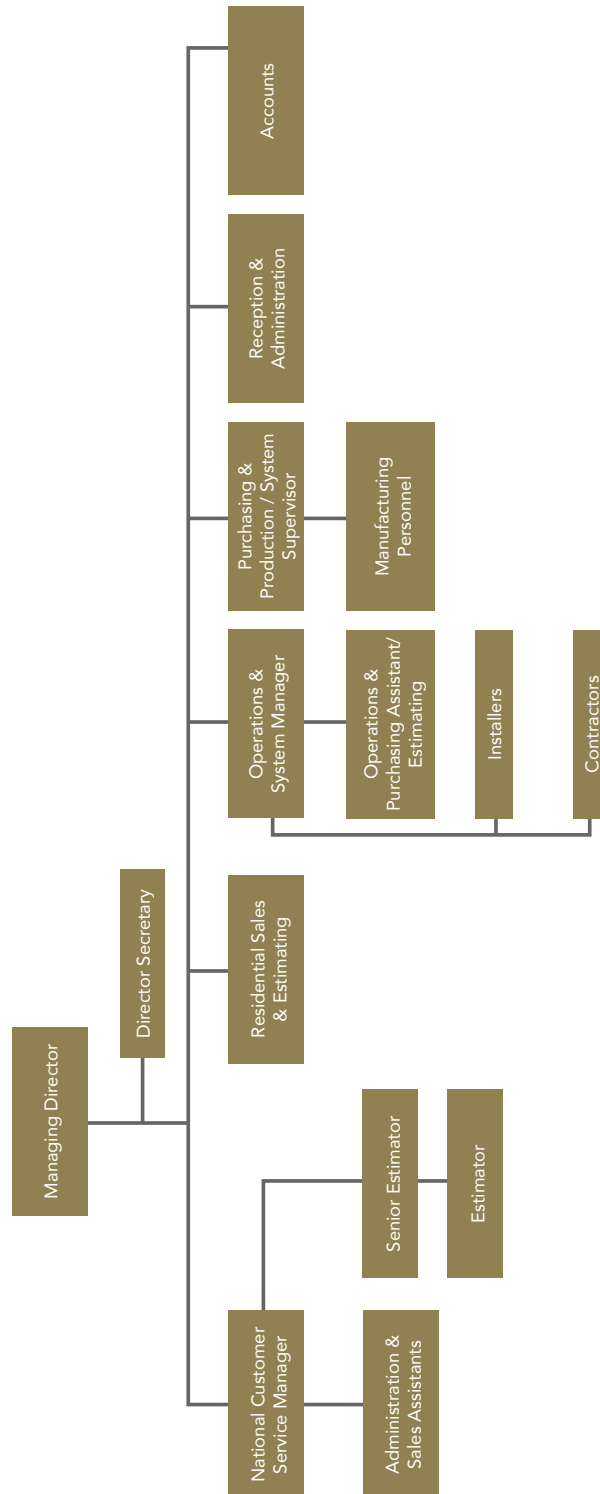

Products & Services

Quicksew has a proven reputation for the provision of versatile window furnishings, soft furnishings and furniture for hospitals, health and aged care facilities, commercial premises, educational facilities, hotel/motels, serviced apartments and resorts.

Quicksew Manufactured Products

Quicksew manufactures products of the highest quality using an extensive variety of innovative and stylish fabrics to suit any budget or application, and includes the following range of products:

Curtains – curtains, stage curtains, pelmets, swags and tails, bedscreens and shower curtains

Blinds – chain drive or motorised roller blinds, Roman blinds and hand drawn vertical blinds

Soft furnishings – bedthrows, bed runners, valances, indoor and outdoor cushions

Our great rapport with fabric manufacturers and suppliers ensures that we have access to the latest technological developments available, such as:

- acoustic management,
- thermal performance,
- infection control; and
- digital printing technology

Outsourced Products

We also offer an extensive range of window treatments and soft furnishings through sourcing and supplying products from other leading industry manufacturers and wholesale suppliers, which include

- Curtain tracks – including standard window track, S – Wave systems, stage tracks and motorised tracks
- Hospital tracks – including quick release and anti-ligature systems, IV tracks and shower tracks
- Venetian blinds – both timber and PVC
- Panel glides
- Shutters & awnings
- Bed Linen and manchester – including bedspreads either quilted or non-quilted, quilt inserts, sheets, pillows, pillowcases, blankets, mattress protectors and shower curtains
- Accessories such as lamps and lighting, mirrors, artworks and ornaments

Quicksew is a preferred supplier for the following manufacturers of window covering systems:

- Verosol – roller blinds, roman blinds, venetian blinds, and pleated blinds
- Vertilux – roller blinds
- Helioscreen – roller blinds and outdoor awnings

Furniture

We source exceptional quality indoor and outdoor furniture and work closely with Australian manufacturers to provide furniture that is fit-for-purpose, stylish and comfortable. We can adapt existing designs to meet special needs. Our range includes -

- Medical & bariatric products
- Bedroom sets including matching head & footrest, bedside tables, chest of drawers and mattresses
- Beds – standard or specialist beds and accessories
- Lounges, chairs, ottomans, dining settings, occasional tables and furniture
- Office furniture, task chairs & beam seating
- Outdoor chairs and tables

Services Offered

Our services include:

- Consultation with customers and industry stakeholders regarding the choice of colour palette and design concept presentation of design concepts to stakeholders and key personnel.
- Assistance with fabric and furniture selection that is fit for purpose, resilient, low maintenance, easy to clean, compliant with fire, health and safety regulations and environmentally conscious.
- Manufacturing of curtains, blinds and soft furnishings; purchasing of specialist indoor and outdoor furniture and products; and coordination of product delivery, project installation and fit-out.

View the entire Quicksew range or download our catalogue on our website www.quicksew.com.au.

Contact Details

Please see our contact details below:

Head Office:

16 Bradwardine Rd
 Bathurst NSW 2795
 Phone: 02 6332 2144

Reception	reception@quicksew.com.au
Jonathan White	jwhite@quicksew.com.au
Aaron White	awhite@quicksew.com.au
Janine Cox	jcox@quicksew.com.au
Gaylene Anderson	ganderson@quicksew.com.au
Samantha Mossman-Riley	sriley@quicksew.com.au



SHOWROOM OPEN: Monday - Friday 8.00am to 5.00pm
16 Bradwardine Road, Bathurst NSW 2795

Freecall 1800 065 068
Email: reception@quicksew.com.au
www.quicksew.com.au