



SUB-ZERO

2022
NEW ZEALAND
PRICE LIST

Table of Contents

Sub-Zero Model Overview 3

Classic Series Refrigeration..... 11

Designer Series Refrigeration..... 22

Designer Series Undercounter Refrigeration..... 31

PRO Series Refrigeration..... 38

Wine Storage..... 43

Accessory Handles..... 49

Sub-Zero Warranties 50

Model numbers, specifications, and prices are subject to change at any time without notice. Visit subzero.com/specs, for the most up-to-date information.

 Indicates Star-K certified.

The information and images in this guide are the copyright property of Sub-Zero, Inc. Neither this guide nor any information or images contained herein may be copied or used in whole or in part without the express written permission of Sub-Zero, Inc. ©Sub-Zero, Inc. all rights reserved.

Sub-Zero, Sub-Zero & Design, Sub-Zero & Snowflake Design, Dual Refrigeration, The Living Kitchen, Great American Kitchens The Fine Art of Kitchen Design, Wolf, Wolf & Design, Wolf Gourmet, W & Design, red colored knobs, Cove, and Cove & Design, are registered trademarks and service marks of Sub-Zero Group, Inc. and its subsidiaries.

All other trademarks are property of their respective owners in the United States and other countries.



Classic Series Refrigeration

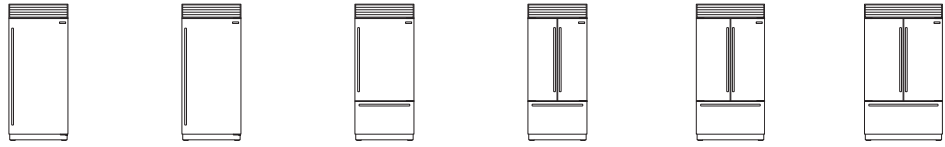

MODEL	ICBCL3650RID	ICBCL3650F	ICBCL3650UID	ICBCL3650UFDID	ICBCL4250UFDID	ICBCL4850UFDID
Product Type	Column	Column	Over-and-Under	Over-and-Under	Over-and-Under	Over-and-Under
Description	All Refrigerator	All Freezer	Refrigerator/Freezer	Refrigerator/Freezer	Refrigerator/Freezer	Refrigerator/Freezer

MODEL / INSTALLATION OPTIONS

Built-In	•	•	•	•	•	•
Overlay						
Integrated						
Side Panels	•	•	•	•	•	•
Dual Installation	•	•	•			

PRICES

Overlay / Integrated						
Stainless Steel (tubular handle)	\$29,999	\$29,999	\$39,495	\$40,999	\$43,495	\$46,495
Stainless Steel (pro handle)	\$29,999	\$29,999	\$39,495	\$40,999	\$43,495	\$46,495

SPECIFICATIONS

Width (mm)	914	914	914	914	1067	1219
Height (mm)	2134	2134	2134	2134	2134	2134
Depth (mm)	610	610	610	610	610	610
Door Clearance (mm)	946	946	946	600	600	677
Refrigerator Gross Volume (L)**	691		472	468	561	654
Refrigerator Storage Volume (L)**	628		425	417	493	577
Refrigerator Total Volume (L)***	646		439	433	520	607
Freezer Gross Volume (L)**		637	168	168	203	237
Freezer Storage Volume (L)**		571	145	145	177	211
Freezer Total Volume (L)***		582	148	148	179	213
Temperature Zones	1	1	2	2	2	2

*For flush inset, add 13 mm. **Volume based on IEC 62552:2007. ***Volume based on IEC 62552-3:2015.

FEATURES

Dual Refrigeration			•	•	•	•
Ice Maker		•	•	•	•	•
Max Ice		•	•	•	•	•
Air Purification System	•		•	•	•	•
Water Filtration System		•	•	•	•	•
Refrigerator Shelves / Door Shelves	4 / 5		3 / 3	3 / 4	6 / 6	6 / 6
Refrigerator Drawers	4		2	2	4	4
Freezer Shelves / Door Shelves		3 / 5				
Freezer Drawers		3	2-tier	2-tier	2-tier	2-tier
Wine Racks						
Internal Water Dispenser	•		•	•	•	•
Ice / Water Dispenser						
Dairy Compartment	•		•	•	•	•

TECHNICAL DATA

European Energy Class*	E	E	E	E	E	E
Temperature Rating	SN-T	SN-T	SN-T	SN-T	SN-T	SN-T
Energy Use (kWh/y)**	156	341	227	226	250	275
Voltage (V~)	220-240	220-240	220-240	220-240	220-240	220-240
Electrical Load (A)	TBD	TBD	TBD	TBD	TBD	TBD
Decibel Rating (dB(A))	TBD	TBD	TBD	TBD	TBD	TBD
Frequency (Hz)	50/60	50/60	50/60	50/60	50/60	50/60

*According to (EU) 2019/2016. **According to IEC 62552-3:2015.

Classic Series Refrigeration

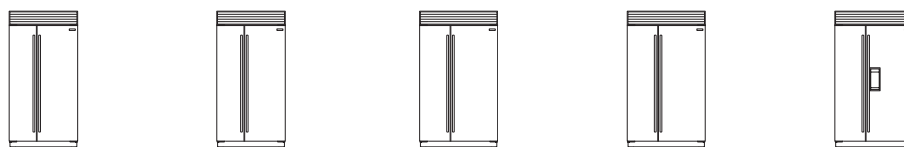

MODEL	ICBCL4250S	ICBCL4250SID	ICBCL4850S	ICBCL4850SID	ICBCL4850SD
Product Type	Side-by-Side	Side-by-Side	Side-by-Side	Side-by-Side	Side-by-Side
Description	Refrigerator/Freezer	Refrigerator/Freezer	Refrigerator/Freezer	Refrigerator/Freezer	Refrigerator/Freezer

MODEL / INSTALLATION OPTIONS

Built-In	•	•	•	•	•
Overlay	•	•	•	•	•
Integrated					
Side Panels	•	•	•	•	•
Dual Installation					

PRICES

Overlay / Integrated	\$33,495	\$35,495	\$35,999	\$38,495	\$38,495
Stainless Steel (tubular handle)	\$39,495	\$41,495	\$42,495	\$44,495	\$44,495
Stainless Steel (pro handle)	\$39,495	\$41,495	\$42,495	\$44,495	\$44,495

SPECIFICATIONS

Width (mm)	1067	1067	1219	1219	1219
Height (mm)	2134	2134	2134	2134	2134
Depth (mm)	610	610	610	610	610
Door Clearance (mm)	668*	668*	762*	762*	762*
Refrigerator Gross Volume (L)**	484	485	568	568	557
Refrigerator Storage Volume (L)**	439	429	516	506	499
Refrigerator Total Volume (L)***	452	441	531	519	506
Freezer Gross Volume (L)**	272	272	322	322	322
Freezer Storage Volume (L)**	243	248	288	294	294
Freezer Total Volume (L)***	248	251	294	298	297
Temperature Zones	2	2	2	2	2

*For flush inset, add 13 mm. **Volume based on IEC 62552:2007. ***Volume based on IEC 62552-3:2015.

FEATURES

Dual Refrigeration	•	•	•	•	•
Ice Maker	•	•	•	•	•
Max Ice	•	•	•	•	•
Air Purification System	•	•	•	•	•
Water Filtration System	•	•	•	•	•
Refrigerator Shelves / Door Shelves	4 / 5	4 / 5	4 / 5	4 / 5	4 / 5
Refrigerator Drawers	4	4	4	4	4
Freezer Shelves / Door Shelves	3 / 5	2.5 / 5	3 / 5	2.5 / 5	2.5 / 5
Freezer Drawers	3	3	3	3	3
Wine Racks					
Internal Water Dispenser		•		•	
Ice / Water Dispenser		•		•	•
Dairy Compartment	•	•	•	•	•

TECHNICAL DATA

European Energy Class*	E	E	E	E	E
Temperature Rating	SN-T	SN-T	SN-T	SN-T	SN-T
Energy Use (kWh/y)**	274	275	302	302	301
Voltage (V~)	220-240	220-240	220-240	220-240	220-240
Electrical Load (A)	TBD	TBD	TBD	TBD	TBD
Decibel Rating (dB(A))	TBD	TBD	TBD	TBD	TBD
Frequency (Hz)	50/60	50/60	50/60	50/60	50/60

*According to (EU) 2019/2016. **According to IEC 62552-3:2015.

Designer Series Refrigeration

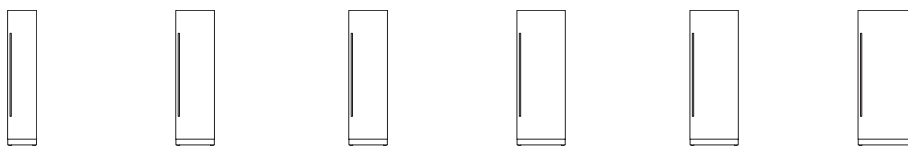

MODEL	ICBDEC1850FI	ICBDEC2450R	ICBDEC2450FI	ICBDEC3050RID	ICBDEC3050FI	ICBDEC3650RID
Product Type	Column	Column	Column	Column	Column	Column
Description	Freezer	Refrigerator	Freezer	Refrigerator	Freezer	Refrigerator

MODEL / INSTALLATION OPTIONS

Built-In						
Overlay						
Integrated	•	•	•	•	•	•
Side Enclosure Panels	•	•	•	•	•	•
Dual Installation	•	•	•	•	•	•

PRICES

Overlay / Integrated	\$23,999	\$25,495	\$25,495	\$27,999	\$26,999	\$29,999
----------------------	----------	----------	----------	----------	----------	----------

SPECIFICATIONS

Width (mm)	457	610	610	762	762	914
Height (mm)	2134	2134	2134	2134	2134	2134
Depth (mm)	610	610	610	610	610	610
Door/Drawer Clearance (mm)	419	572	572	724	724	876
Refrigerator Gross Volume (L)**		402		529		655
Refrigerator Storage Volume (L)**		359		475		592
Refrigerator Total Volume (L)***		377		496		614
Freezer Gross Volume (L)**	277		390		486	
Freezer Storage Volume (L)**	233		336		427	
Freezer Total Volume (L)***	248		351		439	
Temperature Zones	1	1	1	1	1	1

Volume based on IEC 62552:2007. *Volume based on IEC 62552-3:2015.

FEATURES

Dual Refrigeration						
Ice Maker	•		•		•	
Max Ice	•		•		•	
Air Purification System		•		•		•
Water Filtration System	•		•		•	
Refrigerator Shelves / Door Shelves		3 / 5		3 / 5		3 / 5
Refrigerator Drawers		4		4		4
Freezer Shelves / Door Shelves	3 / 5		3 / 5		3 / 5	
Freezer Drawers	3		3		3	
Wine Racks						
Internal Water Dispenser				•		•
Ice / Water Dispenser						
Dairy Compartment		•		•		•

TECHNICAL DATA

European Energy Class*	E	E	E	E	E	E
Temperature Rating	SN-T	SN-T	SN-T	SN-T	SN-T	SN-T
Energy Use (kWh/y)**	237	123	269	137	296	152
Voltage (V~)	220-240	220-240	220-240	220-240	220-240	220-240
Electrical Load (A)	TBD	TBD	TBD	TBD	TBD	TBD
Decibel Rating (dB(A))	TBD	TBD	TBD	TBD	TBD	TBD
Frequency (Hz)	50/60	50/60	50/60	50/60	50/60	50/60

*According to (EU) 2019/2016. **According to IEC 62552-3:2015.

Designer Series Refrigeration



MODEL	ICBDET3050CIID	ICBDET3650CIID
Product Type	Tall	Tall
Description	Refrigerator/Freezer	Refrigerator/Freezer

MODEL / INSTALLATION OPTIONS

Built-In		
Overlay		
Integrated	•	•
Side Enclosure Panels	•	•
Dual Installation	•	•

PRICES

Overlay / Integrated	\$30,495	\$31,999
----------------------	----------	----------

SPECIFICATIONS

Width (mm)	762	914
Height (mm)	2134	2134
Depth (mm)	610	610
Door/Drawer Clearance (mm)	724	876
Refrigerator Gross Volume (L)**	324	402
Refrigerator Storage Volume (L)**	290	360
Refrigerator Total Volume (L)***	303	376
Freezer Gross Volume (L)**	154	193
Freezer Storage Volume (L)**	141	181
Freezer Total Volume (L)***	139	178
Temperature Zones	2	2

Volume based on IEC 62552:2007. *Volume based on IEC 62552-3:2015.

FEATURES

Dual Refrigeration	•	•
Ice Maker	•	•
Max Ice	•	•
Air Purification System	•	•
Water Filtration System	•	•
Refrigerator Shelves / Door Shelves	3 / 3	3 / 3
Refrigerator Drawers	1	1
Freezer Shelves / Door Shelves		
Freezer Drawers	2	2
Wine Racks		
Internal Water Dispenser	•	•
Ice / Water Dispenser		
Dairy Compartment	•	•

TECHNICAL DATA

European Energy Class*	E	E
Temperature Rating	SN-T	SN-T
Energy Use (kWh/y)**	210	235
Voltage (V~)	220-240	220-240
Electrical Load (A)	TBD	TBD
Decibel Rating (dB(A))	TBD	TBD
Frequency (Hz)	50/60	50/60

*According to (EU) 2019/2016. **According to IEC 62552-3:2015.

Designer Series Undercounter Refrigeration

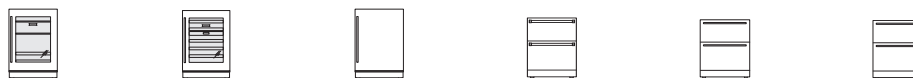

MODEL	ICBDEU2450BG	ICBDEU2450W	ICBDEU2450R	ICBID-24RO	ICBID-30R	ICBID-30FI
Product Type	Undercounter	Undercounter	Undercounter	Drawers	Drawers	Drawers
Description	Beverage Center	Wine Storage	Refrigerator	Refrigerator	Refrigerator	Freezer

MODEL / INSTALLATION OPTIONS

Built-In						
Overlay		•				
Integrated	•	•	•	•	•	•
Side Enclosure Panels						
Dual Installation	•	•	•	•	•	•

PRICES

Overlay / Integrated	\$8,699	\$11,999	\$7,999	\$13,495	\$15,999	\$14,495
----------------------	---------	----------	---------	----------	----------	----------

SPECIFICATIONS

Width (mm)	610	610	610	610	762	762
Height (mm)	876	876	876	876	876	876
Depth (mm)	610	610	610	610	610	610
Door/Drawer Clearance (mm)	572	572	572	451	451	451
Refrigerator Gross Volume (L)**	166		162	123	161	
Refrigerator Storage Volume (L)**	155		152	76	97	
Refrigerator Total Volume (L)***	157		152	114	151	
Freezer Gross Volume (L)**						159
Freezer Storage Volume (L)**						101
Freezer Total Volume (L)***						145
Wine Gross Volume (L)**		154				
Wine Storage Volume (L)**		145				
Wine Total (Volume)***		145				
Wine Storage (750ml bottles)		42				
Temperature Zones	1	2	1	1	1	1
Wine Temperature (°C)		4-18				

Volume based on IEC 62552:2007. *Volume based on IEC 62552-3:2015.

FEATURES

Dual Refrigeration						
Ice Maker						•
Max Ice						•
Air Purification System						
Water Filtration System						
Refrigerator Shelves / Door Shelves	2 / 0		3 / 2			
Refrigerator Drawers	2		1	2	2	
Freezer Shelves / Door Shelves						
Freezer Drawers						2
Wine Racks		15				
Internal Water Dispenser						
Ice / Water Dispenser						
Dairy Compartment						

TECHNICAL DATA

European Energy Class*	D	F	E	E	E	F
Temperature Rating	SN-T	SN-T	SN-T	SN-T	SN-T	SN-T
Energy Use (kWh/y)**	64	105	85	85	92	249
Voltage (V~)	220-240	220-240	220-240	220/240	220-240	220-240
Electrical Load (A)	TBD	0.6	TBD	0.6	0.6	1.4
Decibel Rating (dB(A))	TBD	30	TBD	42	42	42
Frequency (Hz)	50/60	50/60	50/60	50/60	50/60	50/60

*According to (EU) 2019/2016. **According to IEC 62552-3:2015.

PRO Series Refrigeration



MODEL	ICBPRO3650	ICBPRO3650G	ICBPRO4850	ICBPRO4850G
Product Type	PRO	PRO	PRO	PRO
Description	Refrigerator/Freezer	Refrigerator/Freezer	Refrigerator/Freezer	Refrigerator/Freezer

MODEL / INSTALLATION OPTIONS

Built-In	•	•	•	•
Overlay				
Integrated				
Enclosure Panels	•	•	•	•
Dual Installation	•	•		

PRICES

Stainless Steel (pro handle)	\$53,495	\$53,495	\$61,999	\$61,999
------------------------------	----------	----------	----------	----------

SPECIFICATIONS

Width (mm)	914	914	1219	1219
Height (mm)	2134	2134	2134	2134
Depth (mm)	610	610	610	610
Door Clearance (mm)	949	949	781	781
Refrigerator Gross Volume (L)**	563	574	566	574
Refrigerator Storage Volume (L)**	503	513	463	471
Refrigerator Total Volume (L)***	524	534	523	531
Freezer Gross Volume (L)**	126	126	363	363
Freezer Storage Volume (L)**	93	93	280	280
Freezer Total Volume (L)***	126	126	334	334
Temperature Zones	3	3	3	3

Volume based on IEC 62552:2007. *Volume based on IEC 62552-3:2015.

FEATURES

Dual Refrigeration	•	•	•	•
Ice Maker	•	•	•	•
Max Ice	•	•	•	•
Air Purification System	•	•	•	•
Water Filtration System	•	•	•	•
Refrigerator Shelves / Door Shelves	4 / 0	4 / 0	4 / 0	4 / 0
Refrigerator Drawers	1	1	2	2
Freezer Shelves / Door Shelves			4 / 0	4 / 0
Freezer Drawers	1	1	2	2
Wine Racks				
Internal Water Dispenser				
Ice / Water Dispenser				
Dairy Compartment				

TECHNICAL DATA

European Energy Class*	F	F	F	F
Temperature Rating	SN-T	SN-T	SN-T	SN-T
Energy Use (kWh/y)**	368	368	526	526
Voltage (V~)	220-240	220-240	220-240	220-240
Electrical Load (A)	1.5	1.5	1.9	1.9
Decibel Rating (dB(A))	36	36	36	36
Frequency (Hz)	50/60	50/60	50/60	50/60

*According to (EU) 2019/2016. **According to IEC 62552-3:2015.

Wine Storage

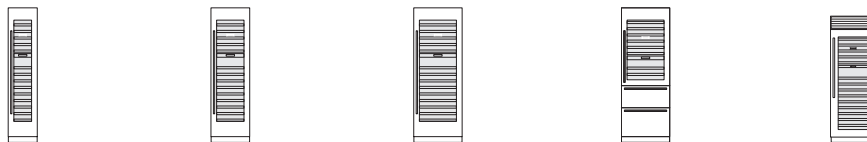

MODEL	ICBDEC1850W	ICBDEC2450W	ICBDEC3050W	ICBDET3050WR	ICBCL3050W
Product Type	Wine Storage	Wine Storage	Wine Storage	Wine Storage	Wine Storage
Description				Refrigerator Drawers	

MODEL / INSTALLATION OPTIONS

Built-In					•
Overlay					•
Integrated	•	•	•	•	
Side Enclosure Panels	•	•	•	•	
Dual Installation	•	•	•	•	•

PRICES

Overlay / Integrated	\$20,999	\$21,999	\$25,999	\$29,999	\$26,999
Stainless Steel (tubular handle)					\$30,495
Stainless Steel (pro handle)					\$30,495

SPECIFICATIONS

Width (mm)	457	610	762	762	762
Height (mm)	2134	2134	2134	2134	2134
Depth (mm)	610	610	610	610	610
Door Clearance (mm)	419	572	724	724	796*
Refrigerator Gross Volume (L)**				157	
Refrigerator Storage Volume (L)**				104	
Refrigerator Total Volume (L)***				148	
Wine Gross Volume (L)**	283	412	541	325	565
Wine Storage Volume (L)**	227	349	470	282	509
Wine Total Volume (L)***	234	355	477	287	517
Wine Storage (750 mL bottles)	59	102	146	86	146
Temperature Zones	2	2	2	3	2
Wine Temperature (°C)	4-18	4-18	4-18	4-18	4-18

*For flush inset, add 13 mm. **Volume based on IEC 62552:2007. ***Volume based on IEC 62552-3:2015.

FEATURES

Dual Refrigeration					
Ice Maker					
Max Ice					
Air Purification System					
Water Filtration System					
Refrigerator Shelves / Door Shelves					
Refrigerator Drawers				2	
Freezer Shelves / Door Shelves					
Freezer Drawers					
Wine Racks	15	15	15	9	14
Internal Water Dispenser					
Ice / Water Dispenser					
Dairy Compartment					

TECHNICAL DATA

European Energy Class*	G	G	G	E	G
Temperature Rating	SN-T	SN-T	SN-T	SN-T	SN-T
Energy Use (kWh/y)**	161	176	192	164	196
Voltage (V~)	220-240	220-240	220-240	220-240	220-240
Electrical Load (A)	TBD	TBD	TBD	TBD	TBD
Decibel Rating (dB(A))	TBD	TBD	TBD	TBD	TBD
Frequency (Hz)	50/60	50/60	50/60	50/60	50/60

*According to (EU) 2019/2016. **According to IEC 62552-3:2015.

Classic Series Refrigeration

Classic Series Refrigeration

In the 1950s, Sub-Zero pioneered the concept of built-in refrigeration. Today, our Classic Series represents the iconic look that comes to mind when one hears "Sub-Zero" with a visible grille and powerful hinges that stand the test of time.

- Split Climate™ intelligent cooling system consistently optimizes refrigerator temperature within 1 degree of set point.
- ClearSight™ LED lighting scheme fully illuminates the interior and reduces shadows.
- Advanced water filtration and air purification systems.
- Available in a stainless steel or custom panel look that can be installed flush inset or proud of surrounding cabinetry.
- Handle options coordinate with Wolf cooking and Cove dishwashing products.
- Flip-up grille provides easy access for routine maintenance.
- One 90° door stop included.
- All models are Star-K certified.

MODEL NUMBER KEY

International Certified Body (ICB) Approved Model	ICB
Classic Series Refrigeration	CL
All Refrigerator	R
All Freezer	F
Over-and-Under	U
French Door	FD
Side-by-Side	S
Ice and Water Dispenser	D
Internal Dispenser	ID
Overlay Model	/O
Stainless Steel Model	/S
Tubular Handle	/T
Pro Handle	/P
Right-Hinge	/R
Left-Hinge	/L

Models are shown with stainless steel panels and tubular handles.

Specify right-hinge (/R) or left-hinge (/L) door when ordering.

Overall dimensions are based on stainless steel models.

All Refrigerator / All Freezer Models



ICBCCL3650RID

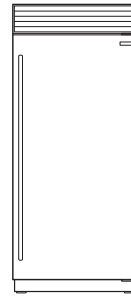

ICBCCL3650F

Over-and-Under Models

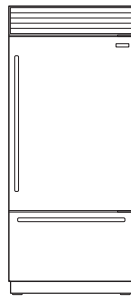

ICBCCL3650UID

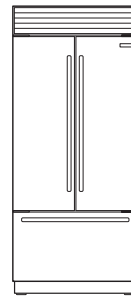

ICBCCL3650UFDID

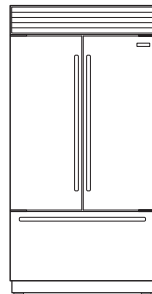

ICBCCL4250UFDID

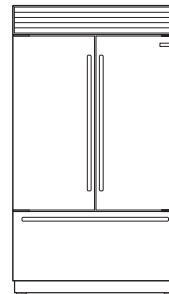

ICBCCL4850UFDID

Side-by-Side Models

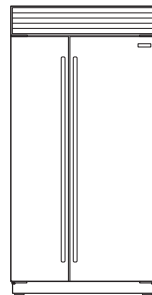

ICBCCL4250S
ICBCCL4250SID

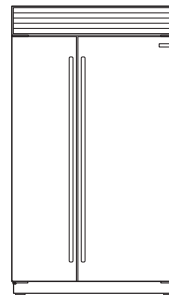

ICBCCL4850S
ICBCCL4850SID

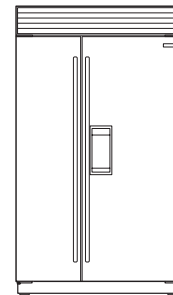

ICBCCL4850SD

Classic Series Refrigeration

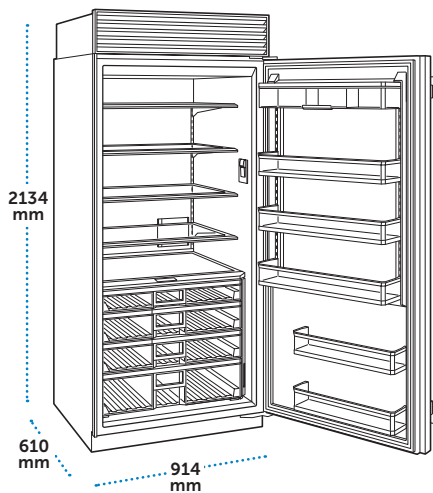

91cm Classic Refrigerator with Internal Water Dispenser

MODEL	COST
ICBCL3650RID/S/T	\$29,999
ICBCL3650RID/S/P	\$29,999

SPECIFICATIONS

Overall Dimensions	914 mm W x 2134 mm H x 610 mm D
Shipping Weight	235 kg

FEATURES

- Split Climate™ intelligent cooling system
- ClearSight™ LED lighting with Night Mode
- Stainless accents
- 4 adjustable glass shelves
- 4 crisper drawers with removable dividers
- 3 adjustable and 2 stationary door shelves
- Flip-up dairy compartment
- Air purification system
- Internal water dispenser
- Water filtration system

Accessories

Grilles

FINISHED HEIGHT	NUMBER	COST
Stainless Steel		
2134 mm Pro Louvered	9044756	\$1,430

Dual Installation Kit

DESCRIPTION	NUMBER	COST
All Designs		
Dual Installation Kit	9040597	\$1,155

For handle-to-handle installations only. Kit includes center trim strip, heater and mounting hardware.

Dual Installation Kit with Dual Wide Grille

DESCRIPTION	NUMBER	COST
Stainless Steel		
1676 mm Pro Louvered	9040595	\$3,840
1829 mm Pro Louvered	9040596	\$3,920

For handle-to-handle installations only. Kit includes dual wide kickplate and dual wide grille for 2134 mm finished height, center trim strip, heater and mounting hardware.

Filters and Cartridges

DESCRIPTION	NUMBER	COST
Replacement Filter		
Water Filter	4204490	\$180
Replacement Cartridge		
Air Purification	7007067	\$180

Miscellaneous

DESCRIPTION	NUMBER	COST
Mounting Kit		
Custom Side Panel	7003407	\$375
Side Panels		
Stainless Steel (1)	9044759	\$2,325
Kickplates		
Stainless Steel RH	9038630	\$155
Stainless Steel LH	9038631	\$155
Egg Container	7007506	\$110
90° Door Stop	7005865	N/C

Classic Series Refrigeration

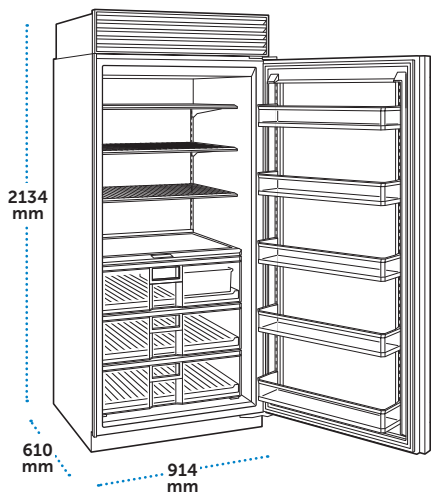

91cm Classic Freezer

MODEL	COST
ICBCL3650F/S/T	\$29,999
ICBCL3650F/S/P	\$29,999

SPECIFICATIONS

Overall Dimensions	914 mm W x 2134 mm H x 610 mm D
Shipping Weight	206 kg

FEATURES

- ClearSight™ LED lighting with Night Mode
- Stainless accents
- 3 adjustable stainless-steel freezer shelves
- 3 storage drawers with adjustable dividers
- 5 adjustable door shelves
- Automatic ice maker with removable ice bin with handle
- Water filtration system

Accessories

Grilles

FINISHED HEIGHT	NUMBER	COST
Stainless Steel		
2134 mm Pro Louvered	9044756	\$1,430

Dual Installation Kit

DESCRIPTION	NUMBER	COST
All Designs		
Dual Installation Kit	9040597	\$1,155

For handle-to-handle installations only. Kit includes center trim strip, heater and mounting hardware.

Dual Installation Kit with Dual Wide Grille

DESCRIPTION	NUMBER	COST
Stainless Steel		
1676 mm Pro Louvered	9040595	\$3,840
1829 mm Pro Louvered	9040596	\$3,920

For handle-to-handle installations only. Kit includes dual wide kickplate and dual wide grille for 2134 mm finished height, center trim strip, heater and mounting hardware.

Filters

DESCRIPTION	NUMBER	COST
Replacement Filter		
Water Filter	4204490	\$180

Miscellaneous

DESCRIPTION	NUMBER	COST
Mounting Kit		
Custom Side Panel	7003407	\$375
Side Panels		
Stainless Steel (1)	9044759	\$2,325
Kickplates		
Stainless Steel RH	9038630	\$155
Stainless Steel LH	9038631	\$155
90° Door Stop	7005865	N/C

Classic Series Refrigeration

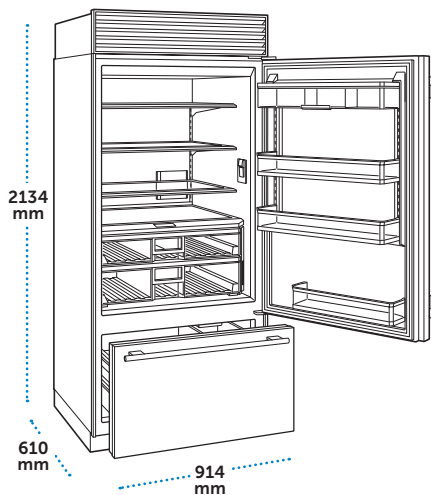

91cm Classic Over-and-Under Refrigerator Freezer with Internal Water Dispenser

MODEL	COST
ICBCL3650UID/S/T	\$39,495
ICBCL3650UID/S/P	\$39,495

SPECIFICATIONS

Overall Dimensions	914 mm W x 2134 mm H x 610 mm D
Shipping Weight	250 kg

FEATURES

- Split Climate™ intelligent cooling system
- ClearSight™ LED lighting with Night Mode
- Stainless accents

Refrigerator

- 3 adjustable glass shelves
- 2 crisper drawers with removable dividers
- 1 stationary and 2 adjustable door shelves
- Flip-up dairy compartment
- Air purification system
- Internal water dispenser

Freezer

- Full-extension drawer with expandable freezer basket
- Automatic ice maker with removable ice container
- Water filtration system

Accessories

Grilles

FINISHED HEIGHT	NUMBER	COST
Stainless Steel		
2134 mm Pro Louvered	9044756	\$1,430

Dual Installation Kit

DESCRIPTION	NUMBER	COST
All Designs		
Dual Installation Kit	9040597	\$1,155

For handle-to-handle installations only. Kit includes center trim strip, heater and mounting hardware.

Dual Installation Kit with Dual Wide Grille

DESCRIPTION	NUMBER	COST
Stainless Steel		
1676 mm Pro Louvered	9040595	\$3,840
1829 mm Pro Louvered	9040596	\$3,920

For handle-to-handle installations only. Kit includes dual wide kickplate and dual wide grille for 2134 mm finished height, center trim strip, heater and mounting hardware.

Filters and Cartridges

DESCRIPTION	NUMBER	COST
Replacement Filter		
Water Filter	4204490	\$180
Replacement Cartridge		
Air Purification	7007067	\$180

Miscellaneous

DESCRIPTION	NUMBER	COST
Mounting Kit		
Custom Side Panel	7003407	\$375
Side Panels		
Stainless Steel (1)	9044759	\$2,325
Egg Container	7007506	\$110
90° Door Stop	7005865	N/C

Classic Series Refrigeration

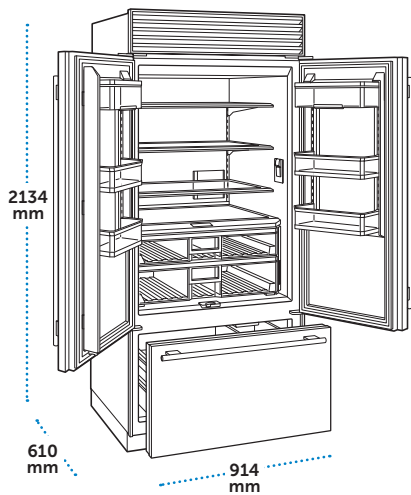

91cm Classic French Door Refrigerator Freezer with Internal Water Dispenser

MODEL	COST
ICBCL3650UFDID/S/T	\$40,999
ICBCL3650UFDID/S/P	\$40,999

SPECIFICATIONS

Overall Dimensions	914 mm W x 2134 mm H x 610 mm D
Shipping Weight	260 kg

FEATURES

- Split Climate™ intelligent cooling system
- ClearSight™ LED lighting with Night Mode
- Stainless accents

Refrigerator

- 3 adjustable glass shelves
- 2 crisper drawers with removable dividers
- 4 adjustable door shelves
- 2 flip-up dairy compartments
- Air purification system
- Internal water dispenser

Freezer

- Full-extension drawer with expandable freezer basket
- Automatic ice maker with removable ice container
- Water filtration system

Accessories

Grilles

FINISHED HEIGHT	NUMBER	COST
Stainless Steel		
2134 mm Pro Louvered	9044756	\$1,430

Filters and Cartridges

DESCRIPTION	NUMBER	COST
Replacement Filter		
Water Filter	4204490	\$180
Replacement Cartridge		
Air Purification	7007067	\$180

Miscellaneous

DESCRIPTION	NUMBER	COST
Mounting Kit		
Custom Side Panel	7003407	\$375
Side Panels		
Stainless Steel (1)	9044759	\$2,325
Stainless Steel Kickplate	9038632	\$145
Egg Container	7007506	\$110
90° Door Stop	7005865	N/C

Classic Series Refrigeration

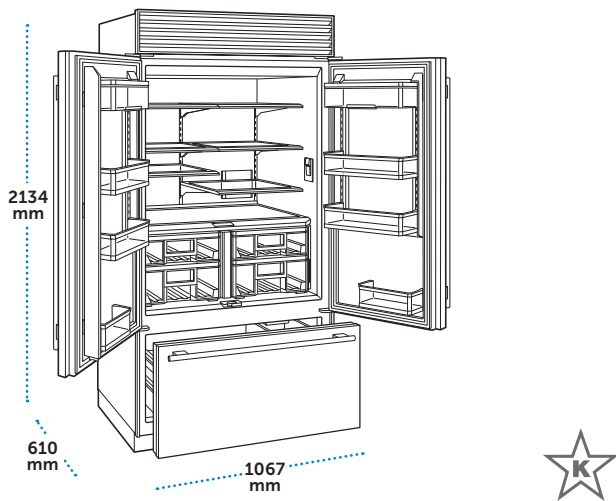

107cm Classic French Door Refrigerator Freezer with Internal Water Dispenser

MODEL	COST
ICBCL4250UFDID/S/T	\$43,495
ICBCL4250UFDID/S/P	\$43,495

SPECIFICATIONS

Overall Dimensions	1067 mm W x 2134 mm H x 610 mm D
Shipping Weight	295 kg

FEATURES

- Split Climate™ intelligent cooling system
- ClearSight™ LED lighting with Night Mode
- Stainless accents

Refrigerator

- 6 adjustable glass shelves
- 4 crisper drawers with removable dividers
- 2 stationary and 4 adjustable door shelves
- 2 flip-up dairy compartments
- Air purification system
- Internal water dispenser

Freezer

- Full-extension drawer with expandable freezer basket
- Automatic ice maker with removable ice container
- Water filtration system

Accessories

Grilles

FINISHED HEIGHT	NUMBER	COST
Stainless Steel		
2134 mm Pro Louvered	9044757	\$1,450

Filters and Cartridges

DESCRIPTION	NUMBER	COST
Replacement Filter		
Water Filter	4204490	\$180
Replacement Cartridge		
Air Purification	7007067	\$180

Miscellaneous

DESCRIPTION	NUMBER	COST
Mounting Kit		
Custom Side Panel	7003407	\$375
Side Panels		
Stainless Steel (1)	9044759	\$2,325
Stainless Steel Kickplate	9038633	\$145
Egg Container	7007506	\$110
90° Door Stop	7005865	N/C

Classic Series Refrigeration

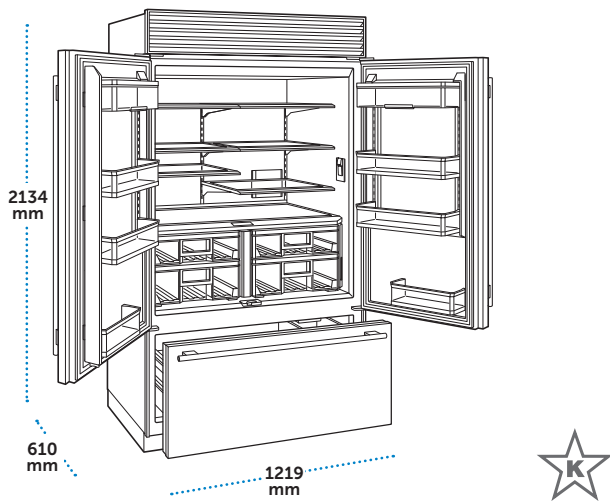

121cm Classic French Door Refrigerator Freezer with Internal Water Dispenser

MODEL	COST
ICBCL4850UFDID/S/T	\$46,495
ICBCL4850UFDID/S/P	\$46,495

SPECIFICATIONS

Overall Dimensions	1219 mm W x 2134 mm H x 610 mm D
Shipping Weight	321 kg

FEATURES

- Split Climate™ intelligent cooling system
- ClearSight™ LED lighting with Night Mode
- Stainless accents

Refrigerator

- 6 adjustable glass shelves
- 4 crisper drawers with removable dividers
- 2 stationary and 4 adjustable door shelves
- 2 flip-up dairy compartments
- Air purification system
- Internal water dispenser

Freezer

- Full-extension drawer with expandable freezer basket
- Automatic ice maker with removable ice container
- Water filtration system

Accessories

Grilles

FINISHED HEIGHT	NUMBER	COST
Stainless Steel		
2134 mm Pro Louvered	9044758	\$1,515

Filters and Cartridges

DESCRIPTION	NUMBER	COST
Replacement Filter		
Water Filter	4204490	\$180
Replacement Cartridge		
Air Purification	7007067	\$180

Miscellaneous

DESCRIPTION	NUMBER	COST
Mounting Kit		
Custom Side Panel	7003407	\$375
Side Panels		
Stainless Steel (1)	9044759	\$2,325
Stainless Steel Kickplate	9038634	\$145
Egg Container	7007506	\$110
90° Door Stop	7005865	N/C

Classic Series Refrigeration

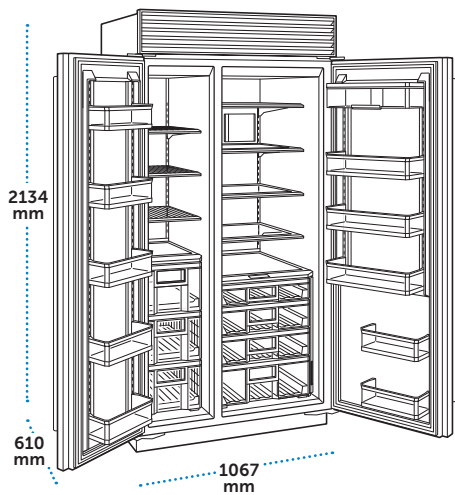

107cm Classic Side-By-Side Refrigerator Freezer

MODEL	COST
ICBCL4250S/O	\$33,495
ICBCL4250S/S/T	\$39,495
ICBCL4250S/S/P	\$39,495

SPECIFICATIONS

Overall Dimensions	1067 mm W x 2134 mm H x 610 mm D
Shipping Weight	281 kg

FEATURES

- Split Climate™ intelligent cooling system
- ClearSight™ LED lighting with Night Mode
- Stainless accents

Refrigerator

- 4 adjustable glass shelves
- 4 crisper drawers with removable dividers
- 2 stationary and 3 adjustable door shelves
- Flip-up dairy compartment
- Air purification system

Freezer

- Ice drawer with automatic ice maker
- 3 adjustable wire shelves
- 5 adjustable door shelves
- 2 storage drawers
- Water filtration system

Accessories

Grilles

FINISHED HEIGHT	NUMBER	COST
Overlay or Flush Inset		
2134 mm Grille Frame	9044753	\$850
Stainless Steel		
2134 mm Pro Louvered	9044757	\$1,450

Single Flush Inset – Stainless Steel

DESCRIPTION	NUMBER	COST
Grilles		
2134 mm Solid SS	9036855	\$925
2134 mm Pro Louvered	9045095	\$1,155
Pro Handle		
Refrigerator Door Panel	9036857	\$2,515
Freezer Door Panel	9036860	\$2,285
Tubular Handle		
Refrigerator Door Panel	9036861	\$2,515
Freezer Door Panel	9036863	\$2,285

Retrofit Panel Kit

DESCRIPTION	NUMBER	COST
Overlay or Flush Inset		
1067 mm Retrofit Panel Kit	9038296	\$1,080

Retrofit existing Built-In (BI) Series panels onto a new Classic (CL) Series model. Grille panel must be reduced in height by 38 mm.

Filters and Cartridges

DESCRIPTION	NUMBER	COST
Replacement Filter		
Water Filter	4204490	\$180
Replacement Cartridge		
Air Purification	7007067	\$180

Miscellaneous

DESCRIPTION	NUMBER	COST
Mounting Kits		
Custom Front Panel	9044760	\$720
Custom Side Panel	7003407	\$375
Side Panels		
Stainless Steel (1)	9044759	\$2,325
Stainless Steel Kickplate	9038633	\$145
Egg Container	7007506	\$110
90° Door Stop	7005865	N/C

Classic Series Refrigeration

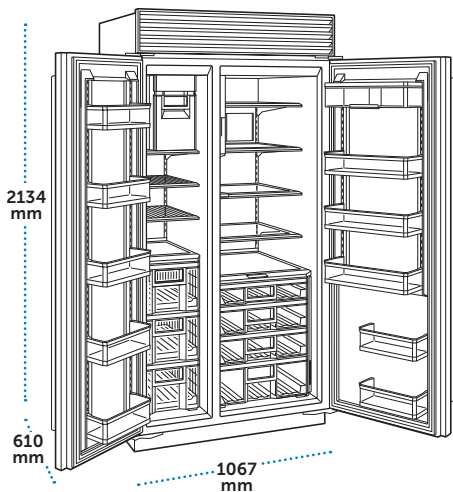

107cm Classic Side-By-Side Refrigerator Freezer with Internal Water Dispenser

MODEL	COST
ICBCL4250SID/O	\$35,495
ICBCL4250SID/S/T	\$41,495
ICBCL4250SID/S/P	\$41,495

SPECIFICATIONS

Overall Dimensions	1067 mm W x 2134 mm H x 610 mm D
Shipping Weight	283 kg

FEATURES

- Split Climate™ intelligent cooling system
- ClearSight™ LED lighting with Night Mode
- Stainless accents

Refrigerator

- 4 adjustable glass shelves
- 4 crisper drawers with removable dividers
- 2 stationary and 3 adjustable door shelves
- Flip-up dairy compartment
- Air purification system
- Internal ice and water dispenser

Freezer

- 2 adjustable wire shelves
- 5 adjustable door shelves
- 3 storage drawers
- Fold-up shelf
- Water filtration system

Accessories

Grilles

FINISHED HEIGHT	NUMBER	COST
Overlay or Flush Inset		
2134 mm Grille Frame	9044753	\$850
Stainless Steel		
2134 mm Pro Louvered	9044757	\$1,450

Single Flush Inset – Stainless Steel

DESCRIPTION	NUMBER	COST
Grilles		
2134 mm Solid SS	9036855	\$925
2134 mm Pro Louvered	9045095	\$1,155
Pro Handle		
Refrigerator Door Panel	9036857	\$2,515
Freezer Door Panel	9036860	\$2,285
Tubular Handle		
Refrigerator Door Panel	9036861	\$2,515
Freezer Door Panel	9036863	\$2,285

Retrofit Panel Kit

DESCRIPTION	NUMBER	COST
Overlay or Flush Inset		
1067 mm Retrofit Panel Kit	9038296	\$1,080

Retrofit existing Built-In (BI) Series panels onto a new Classic (CL) Series model. Grille panel must be reduced in height by 38 mm.

Filters and Cartridges

DESCRIPTION	NUMBER	COST
Replacement Filter		
Water Filter	4204490	\$180
Replacement Cartridge		
Air Purification	7007067	\$180

Miscellaneous

DESCRIPTION	NUMBER	COST
Mounting Kits		
Custom Front Panel	9044760	\$720
Custom Side Panel	7003407	\$375
Side Panels		
Stainless Steel (1)	9044759	\$2,325
Stainless Steel Kickplate	9038633	\$145
Egg Container	7007506	\$110
90° Door Stop	7005865	N/C

Classic Series Refrigeration

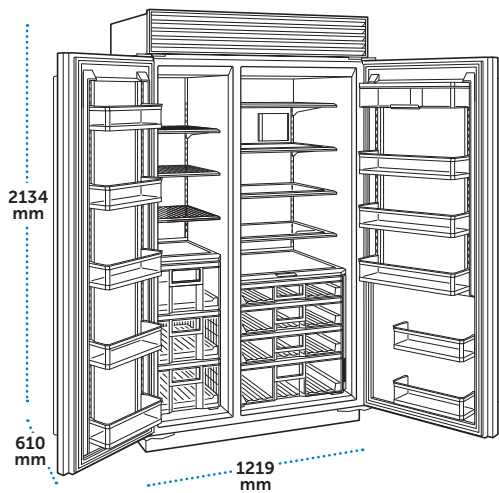

122cm Classic Side-by-Side Refrigerator Freezer

MODEL	COST
ICBCL4850S/O	\$35,999
ICBCL4850S/S/T	\$42,495
ICBCL4850S/S/P	\$42,495

SPECIFICATIONS

Overall Dimensions	1219 mm W x 2134 mm H x 610 mm D
Shipping Weight	318 kg

FEATURES

- Split Climate™ intelligent cooling system
- ClearSight™ LED lighting with Night Mode
- Stainless accents

Refrigerator

- 4 adjustable glass shelves
- 4 crisper drawers with removable dividers
- 2 stationary and 3 adjustable door shelves
- Flip-up dairy compartment
- Air purification system

Freezer

- Ice drawer with automatic ice maker
- 3 adjustable wire shelves
- 5 adjustable door shelves
- 2 storage drawers
- Water filtration system

Accessories

Grilles

FINISHED HEIGHT	NUMBER	COST
Overlay or Flush Inset		
2134 mm Grille Frame	9044754	\$875
Stainless Steel		
2134 mm Pro Louvered	9044758	\$1,515

Single Flush Inset – Stainless Steel

DESCRIPTION	NUMBER	COST
Grilles		
2134 mm Solid SS	9036856	\$1,030
2134 mm Pro Louvered	9045096	\$1,210
Pro Handle		
Refrigerator Door Panel	9036864	\$2,595
Freezer Door Panel	9036866	\$2,360
Tubular Handle		
Refrigerator Door Panel	9036867	\$2,595
Freezer Door Panel	9036869	\$2,360

Retrofit Panel Kit

DESCRIPTION	NUMBER	COST
Overlay or Flush Inset		
1219 mm Retrofit Panel Kit	9038297	\$1,105

Retrofit existing Built-In (BI) Series panels onto a new Classic (CL) Series model. Grille panel must be reduced in height by 38 mm.

Filters and Cartridges

DESCRIPTION	NUMBER	COST
Replacement Filter		
Water Filter	4204490	\$180
Replacement Cartridge		
Air Purification	7007067	\$180

Miscellaneous

DESCRIPTION	NUMBER	COST
Mounting Kits		
Custom Front Panel	9044760	\$720
Custom Side Panel	7003407	\$375
Side Panels		
Stainless Steel (1)	9044759	\$2,325
Stainless Steel Kickplate	9038634	\$145
Egg Container	7007506	\$110
90° Door Stop	7005865	N/C

Classic Series Refrigeration

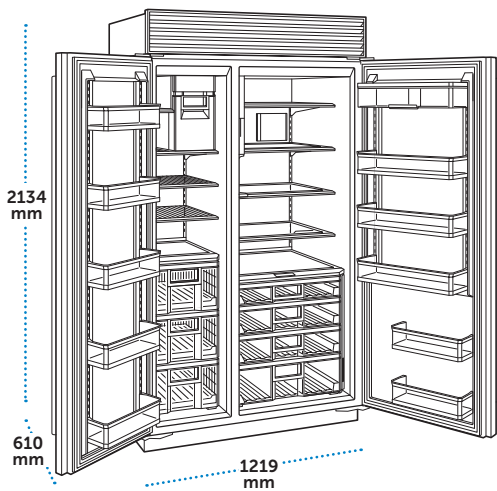

122cm Classic Side-by-Side Refrigerator Freezer with Internal Water Dispenser

MODEL	COST
ICBCL4850SID/O	\$38,495
ICBCL4850SID/S/T	\$44,495
ICBCL4850SID/S/P	\$44,495

SPECIFICATIONS

Overall Dimensions	1219 mm W x 2134 mm H x 610 mm D
Shipping Weight	320 kg

FEATURES

- Split Climate™ intelligent cooling system
- ClearSight™ LED lighting with Night Mode
- Stainless accents

Refrigerator

- 4 adjustable glass shelves
- 4 crisper drawers with removable dividers
- 2 stationary and 3 adjustable door shelves
- Flip-up dairy compartment
- Air purification system
- Internal ice and water dispenser

Freezer

- 2 adjustable wire shelves
- 5 adjustable door shelves
- 3 storage drawers
- Fold-up shelf
- Water filtration system

Accessories

Grilles

FINISHED HEIGHT	NUMBER	COST
Overlay or Flush Inset		
2134 mm Grille Frame	9044754	\$875
Stainless Steel		
2134 mm Pro Louvered	9044758	\$1,515

Single Flush Inset – Stainless Steel

DESCRIPTION	NUMBER	COST
Grilles		
2134 mm Solid SS	9036856	\$1,030
2134 mm Pro Louvered	9045096	\$1,210
Pro Handle		
Refrigerator Door Panel	9036864	\$2,595
Freezer Door Panel	9036866	\$2,360
Tubular Handle		
Refrigerator Door Panel	9036867	\$2,595
Freezer Door Panel	9036869	\$2,360

Retrofit Panel Kit

DESCRIPTION	NUMBER	COST
Overlay or Flush Inset		
1219 mm Retrofit Panel Kit	9038297	\$1,105

Retrofit existing Built-In (BI) Series panels onto a new Classic (CL) Series model. Grille panel must be reduced in height by 38 mm.

Filters and Cartridges

DESCRIPTION	NUMBER	COST
Replacement Filter		
Water Filter	4204490	\$180
Replacement Cartridge		
Air Purification	7007067	\$180

Miscellaneous

DESCRIPTION	NUMBER	COST
Mounting Kits		
Custom Front Panel	9044760	\$720
Custom Side Panel	7003407	\$375
Side Panels		
Stainless Steel (1)	9044759	\$2,325
Stainless Steel Kickplate	9038634	\$145
Egg Container	7007506	\$110
90° Door Stop	7005865	N/C

Classic Series Refrigeration

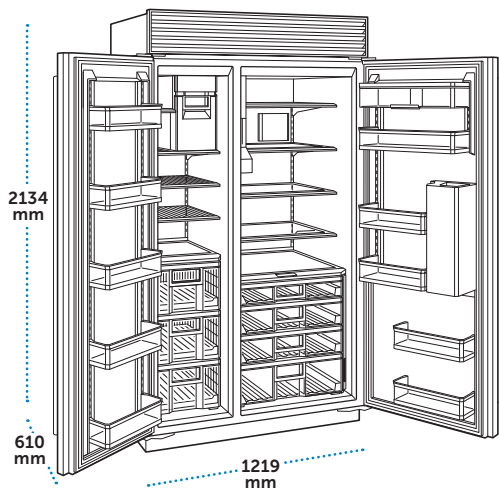

122cm Classic Side-by-Side Refrigerator Freezer with Water & Ice Dispenser

MODEL	COST
ICBCL4850SD/O	\$38,495
ICBCL4850SD/S/T	\$44,495
ICBCL4850SD/S/P	\$44,495

SPECIFICATIONS

Overall Dimensions	1219 mm W x 2134 mm H x 610 mm D
Shipping Weight	323 kg

FEATURES

- Split Climate™ intelligent cooling system
- ClearSight™ LED lighting with Night Mode
- Stainless accents

Refrigerator

- 4 adjustable glass shelves
- 4 crisper drawers with removable dividers
- 2 stationary and 3 adjustable door shelves
- Flip-up dairy compartment
- Air purification system

Freezer

- Automatic ice maker with external dispenser
- 2 adjustable wire shelves
- 5 adjustable door shelves
- 3 storage drawers
- Fold-up shelf
- Water filtration system

Accessories

Grilles

FINISHED HEIGHT	NUMBER	COST
Overlay or Flush Inset		
2134 mm Grille Frame	9044754	\$875
Stainless Steel		
2134 mm Pro Louvered	9044758	\$1,515

Single Flush Inset – Stainless Steel

DESCRIPTION	NUMBER	COST
Grilles		
2134 mm Solid SS	9036856	\$1,030
2134 mm Pro Louvered	9045096	\$1,210
Pro Handle		
Refrigerator Door Panel	9036865	\$2,595
Freezer Door Panel	9036866	\$2,360
Tubular Handle		
Refrigerator Door Panel	9036868	\$2,595
Freezer Door Panel	9036869	\$2,360

Filters and Cartridges

DESCRIPTION	NUMBER	COST
Replacement Filter		
Water Filter	4204490	\$180
Replacement Cartridge		
Air Purification	7007067	\$180

Miscellaneous

DESCRIPTION	NUMBER	COST
Mounting Kits		
Custom Front Panel	9044760	\$720
Custom Side Panel	7003407	\$375
Side Panels		
Stainless Steel (1)	9044759	\$2,325
Stainless Steel Kickplate	9038634	\$145
Egg Container	7007506	\$110
90° Door Stop	7005865	N/C

Designer Series Refrigeration

Sub-Zero Designer Series models are installed flush to merge seamlessly into their surroundings, making them as practical and beautiful in the master suite, bar, or theatre as in the kitchen. For a more traditional look, Designer Series units can be fitted with stainless steel accessory panels.

MODEL NUMBER KEY

International Certified Body (ICB) Approved Model	ICB
Designer Series Column	DEC
Designer Series Tall	DET
All Refrigerator	R
All Freezer	F
Combination Refrigerator/Freezer	C
Internal Dispenser	ID
Ice Maker	I
Right-Hinge	/R
Left-Hinge	/L

Models are shown with stainless steel panels and tubular handles.

Specify right-hinge (/R) or left-hinge (/L) door when ordering.

Overall dimensions do not include panels or handles. Dimensions will vary with panel thickness.

Column Models

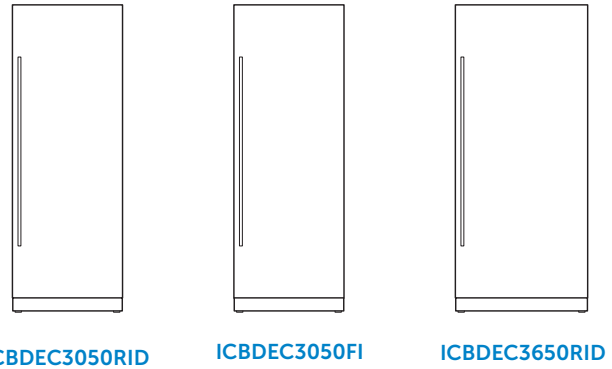
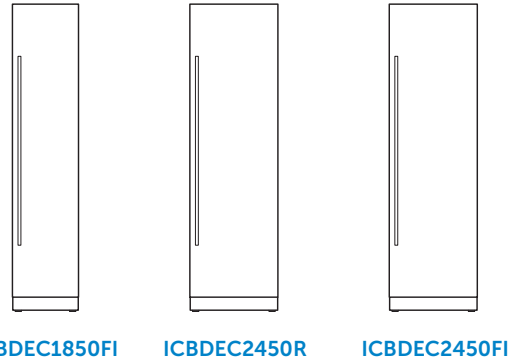

Tall Models

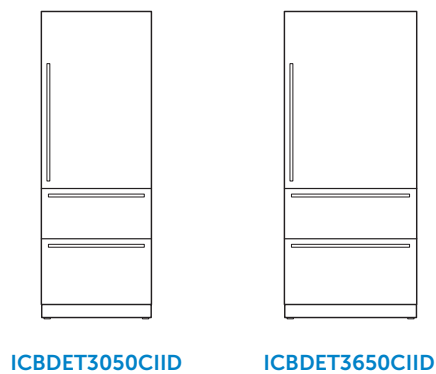

Designer Series Refrigeration

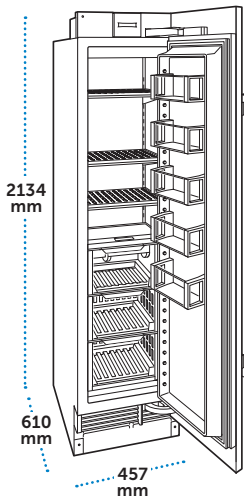

46cm Designer Column Freezer with Ice Maker

MODEL	COST
ICBDEC1850FI	\$23,999

SPECIFICATIONS

Overall Dimensions	457 mm W x 2134 mm H x 610 mm D
Shipping Weight	129 kg

FEATURES

- ClearSight™ LED lighting with Night Mode
- Stainless accents
- 3 adjustable wire shelves
- 2 storage drawers with adjustable dividers
- 5 adjustable door shelves
- Ice drawer with automatic ice maker
- Water filtration system

Accessories

Stainless Steel Door Panels

DESCRIPTION	NUMBER	COST
2134 mm Fin Height – 102 mm Toe Kick		
Tubular Handle / RH	7025372	\$1,760
Tubular Handle / LH	7025373	\$1,760
Pro Handle / RH	7025324	\$1,760
Pro Handle / LH	7025325	\$1,760

Dual Installation

DESCRIPTION	NUMBER	COST
Dual Installation Kits		
Handle-to-Handle	7027904	\$785
Handle-to-Hinge	7030378	\$785
Hinge-to-Hinge	7030379	\$785

Kickplates

914 mm Stainless Steel	7026837	\$180
1067 mm Stainless Steel	7027399	\$180
1219 mm Stainless Steel	7026838	\$180
1372 mm Stainless Steel	7026839	\$180

Filters

DESCRIPTION	NUMBER	COST
Replacement Filter		
Water Filter	4204490	\$180

Miscellaneous

DESCRIPTION	NUMBER	COST
Enclosure Panel		
Stainless Steel Side (1)	7031340	\$3,115
Reduced Toe Kick Divider	7029956	\$145

Designer Series Refrigeration

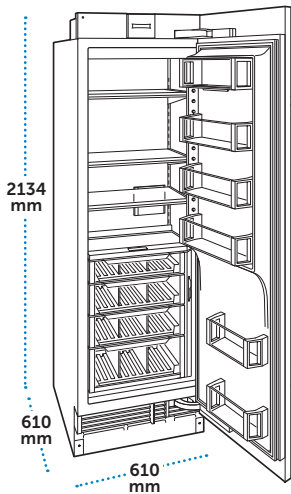

61cm Designer Column Refrigerator

MODEL	COST
ICBDEC2450R	\$25,495

SPECIFICATIONS

Overall Dimensions	610 mm W x 2134 mm H x 610 mm D
Shipping Weight	166 kg

FEATURES

- Split Climate™ intelligent cooling system
- ClearSight™ LED lighting with Night Mode
- Stainless accents
- 3 adjustable glass shelves
- 4 soft-close crisper drawers with adjustable dividers
- 3 adjustable and 2 stationary door shelves
- Flip-up dairy compartment
- Air purification system

Accessories

Stainless Steel Door Panels

DESCRIPTION	NUMBER	COST
2134 mm Fin Height – 102 mm Toe Kick		
Tubular Handle / RH	7023710	\$2,080
Tubular Handle / LH	7023711	\$2,080
Pro Handle / RH	7025320	\$2,080
Pro Handle / LH	7025321	\$2,080

Dual Installation

DESCRIPTION	NUMBER	COST
Dual Installation Kits		
Handle-to-Handle	7027904	\$785
Handle-to-Hinge	7030378	\$785
Hinge-to-Hinge	7030379	\$785

Kickplates

1067 mm Stainless Steel	7027399	\$180
1219 mm Stainless Steel	7026838	\$180
1372 mm Stainless Steel	7026839	\$180
1524 mm Stainless Steel	7026840	\$210

Cartridges

DESCRIPTION	NUMBER	COST
Replacement Cartridge		
Air Purification	7007067	\$180

Miscellaneous

DESCRIPTION	NUMBER	COST
Enclosure Panel		
Stainless Steel Side (1)	7031340	\$3,115
Reduced Toe Kick Divider	7029956	\$145
Egg Container	7007506	\$110

Designer Series Refrigeration

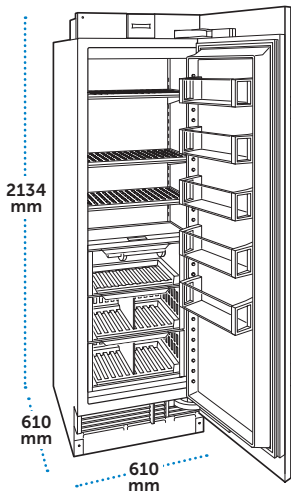

61cm Designer Column Freezer with Ice Maker

MODEL	COST
ICBDEC2450FI	\$25,495

SPECIFICATIONS

Overall Dimensions	610 mm W x 2134 mm H x 610 mm D
Shipping Weight	166 kg

FEATURES

- ClearSight™ LED lighting with Night Mode
- Stainless accents
- 3 adjustable wire shelves
- 2 storage drawers with adjustable dividers
- 5 adjustable door shelves
- Ice drawer with automatic ice maker
- Water filtration system

Accessories

Stainless Steel Door Panels

DESCRIPTION	NUMBER	COST
2134 mm Fin Height – 102 mm Toe Kick		
Tubular Handle / RH	7023710	\$2,080
Tubular Handle / LH	7023711	\$2,080
Pro Handle / RH	7025320	\$2,080
Pro Handle / LH	7025321	\$2,080

Dual Installation

DESCRIPTION	NUMBER	COST
Dual Installation Kits		
Handle-to-Handle	7027904	\$785
Handle-to-Hinge	7030378	\$785
Hinge-to-Hinge	7030379	\$785

Kickplates

1067 mm Stainless Steel	7027399	\$180
1219 mm Stainless Steel	7026838	\$180
1372 mm Stainless Steel	7026839	\$180
1524 mm Stainless Steel	7026840	\$210

Filters

DESCRIPTION	NUMBER	COST
Replacement Filter		
Water Filter	4204490	\$180

Miscellaneous

DESCRIPTION	NUMBER	COST
Enclosure Panel		
Stainless Steel Side (1)	7031340	\$3,115
Reduced Toe Kick Divider	7029956	\$145

Designer Series Refrigeration

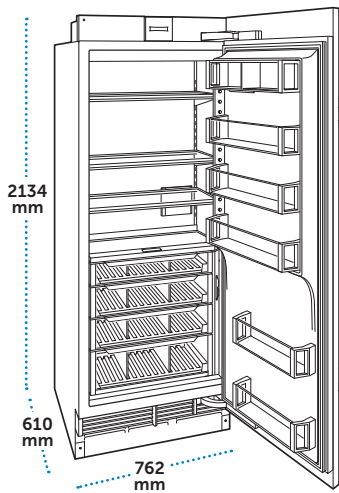

76cm Designer Column Refrigerator with Internal Water Dispenser

MODEL	COST
ICBDEC3050RID	\$27,999

SPECIFICATIONS

Overall Dimensions	762 mm W x 2134 mm H x 610 mm D
Shipping Weight	193 kg

FEATURES

- Split Climate™ intelligent cooling system
- ClearSight™ LED lighting with Night Mode
- Stainless accents
- 3 adjustable glass shelves
- 4 soft-close crisper drawers with adjustable dividers
- 3 adjustable and 2 stationary door shelves
- Flip-up dairy compartment
- Air purification system
- Internal water dispenser
- Water filtration system

Accessories

Stainless Steel Door Panels

DESCRIPTION	NUMBER	COST
2134 mm Fin Height – 102 mm Toe Kick		
Tubular Handle / RH	7023626	\$2,420
Tubular Handle / LH	7023627	\$2,420
Pro Handle / RH	7025304	\$2,420
Pro Handle / LH	7025305	\$2,420

Dual Installation

DESCRIPTION	NUMBER	COST
Dual Installation Kits		
Handle-to-Handle	7027904	\$785
Handle-to-Hinge	7030378	\$785
Hinge-to-Hinge	7030379	\$785

Kickplates

1219 mm Stainless Steel	7026838	\$180
1372 mm Stainless Steel	7026839	\$180
1524 mm Stainless Steel	7026840	\$210
1676 mm Stainless Steel	7026841	\$235

Filters and Cartridges

DESCRIPTION	NUMBER	COST
Replacement Filter		
Water Filter	4204490	\$180
Replacement Cartridge		
Air Purification	7007067	\$180

Miscellaneous

DESCRIPTION	NUMBER	COST
Enclosure Panel		
Stainless Steel Side (1)	7031340	\$3,115
Reduced Toe Kick Divider	7029956	\$145
Egg Container	7007506	\$110

Designer Series Refrigeration

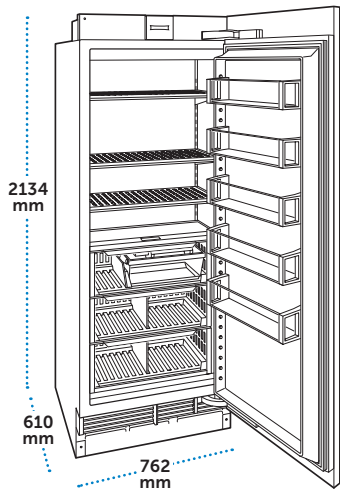

76cm Designer Column Freezer with Ice Maker

MODEL	COST
ICBDEC3050FI	\$26,999

SPECIFICATIONS

Overall Dimensions	762 mm W x 2134 mm H x 610 mm D
Shipping Weight	193 kg

FEATURES

- ClearSight™ LED lighting with Night Mode
- Stainless accents
- 3 adjustable wire shelves
- 3 storage drawers
- 5 adjustable door shelves
- Automatic ice maker with removable ice container
- Water filtration system

Accessories

Stainless Steel Door Panels

DESCRIPTION	NUMBER	COST
2134 mm Fin Height – 102 mm Toe Kick		
Tubular Handle / RH	7023626	\$2,420
Tubular Handle / LH	7023627	\$2,420
Pro Handle / RH	7025304	\$2,420
Pro Handle / LH	7025305	\$2,420

Dual Installation

DESCRIPTION	NUMBER	COST
Dual Installation Kits		
Handle-to-Handle	7027904	\$785
Handle-to-Hinge	7030378	\$785
Hinge-to-Hinge	7030379	\$785

Kickplates

1219 mm Stainless Steel	7026838	\$180
1372 mm Stainless Steel	7026839	\$180
1524 mm Stainless Steel	7026840	\$210
1676 mm Stainless Steel	7026841	\$235

Filters

DESCRIPTION	NUMBER	COST
Replacement Filter		
Water Filter	4204490	\$180

Miscellaneous

DESCRIPTION	NUMBER	COST
Enclosure Panel		
Stainless Steel Side (1)	7031340	\$3,115
Reduced Toe Kick Divider	7029956	\$145

Designer Series Refrigeration

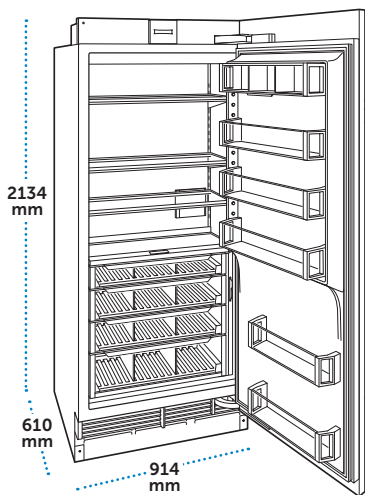

91cm Designer Column Refrigerator with Internal Water Dispenser

MODEL	COST
ICBDEC3650RID	\$29,999

SPECIFICATIONS

Overall Dimensions	914 mm W x 2134 mm H x 610 mm D
Shipping Weight	220 kg

FEATURES

- Split Climate™ intelligent cooling system
- ClearSight™ LED lighting with Night Mode
- Stainless accents
- 3 adjustable glass shelves
- 4 soft-close crisper drawers with adjustable dividers
- 3 adjustable and 2 stationary door shelves
- Flip-up dairy compartment
- Air purification system
- Internal water dispenser
- Water filtration system

Accessories

Stainless Steel Door Panels

DESCRIPTION	NUMBER	COST
2134 mm Fin Height – 102 mm Toe Kick		
Tubular Handle / RH	7025366	\$2,740
Tubular Handle / LH	7025367	\$2,740
Pro Handle / RH	7025316	\$2,740
Pro Handle / LH	7025317	\$2,740

Dual Installation

DESCRIPTION	NUMBER	COST
Dual Installation Kits		
Handle-to-Handle	7027904	\$785
Handle-to-Hinge	7030378	\$785
Hinge-to-Hinge	7030379	\$785

Kickplates

1372 mm Stainless Steel	7026839	\$180
1524 mm Stainless Steel	7026840	\$210
1676 mm Stainless Steel	7026841	\$235
1829 mm Stainless Steel	7026842	\$235

Filters and Cartridges

DESCRIPTION	NUMBER	COST
Replacement Filter		
Water Filter	4204490	\$180
Replacement Cartridge		
Air Purification	7007067	\$180

Miscellaneous

DESCRIPTION	NUMBER	COST
Enclosure Panel		
Stainless Steel Side (1)	7031340	\$3,115
Reduced Toe Kick Divider	7029956	\$145
Egg Container	7007506	\$110

Designer Series Refrigeration

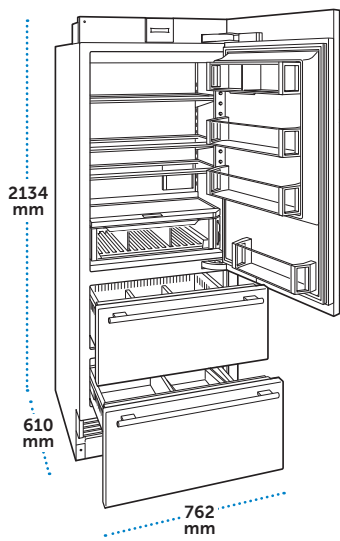

76cm Designer Over-and-Under Refrigerator Freezer with Internal Water Dispenser & Ice Maker

MODEL	COST
ICBDET3050CIID	\$30,495

SPECIFICATIONS

Overall Dimensions	762 mm W x 2134 mm H x 610 mm D
Shipping Weight	181 kg

FEATURES

- Split Climate™ intelligent cooling system
- ClearSight™ LED lighting with Night Mode
- Stainless accents
- 2 temperature zones

Refrigerator

- 3 adjustable glass shelves
- Crisper drawer with dividers
- 1 stationary and 2 adjustable door shelves
- Flip-up dairy compartment
- Air purification system
- Internal water dispenser

Freezer

- 2 full-extension freezer drawers; one with adjustable dividers
- Automatic ice maker with removable ice container
- Water filtration system

Accessories

Stainless Steel Door Panels

DESCRIPTION	NUMBER	COST
2134 mm Finished Height		
Tubular Handle / RH	7023706	\$2,080
Tubular Handle / LH	7023707	\$2,080
Pro Handle / RH	7025312	\$2,080
Pro Handle / LH	7025313	\$2,080

Stainless Steel Drawer Panels (2-panel set)

DESCRIPTION	NUMBER	COST
102 mm Toe Kick		
Tubular Handle	7023702	\$1,760
Pro Handle	7025308	\$1,760

Dual Installation

DESCRIPTION	NUMBER	COST
Dual Installation Kits		
Handle-to-Handle	7027904	\$785
Handle-to-Hinge	7030378	\$785
Hinge-to-Hinge	7030379	\$785
Kickplates		
1219 mm Stainless Steel	7026838	\$180
1372 mm Stainless Steel	7026839	\$180
1524 mm Stainless Steel	7026840	\$210
1676 mm Stainless Steel	7026841	\$235

Filters and Cartridges

DESCRIPTION	NUMBER	COST
Replacement Filter		
Water Filter	4204490	\$180
Replacement Cartridge		
Air Purification	7007067	\$180

Miscellaneous

DESCRIPTION	NUMBER	COST
Enclosure Panel		
Stainless Steel Side (1)	7031340	\$3,115
Mounting Kit		
Drawer Panel Support	7028082	\$65
Reduced Toe Kick Divider	7029956	\$145
Egg Container	7007506	\$110

Designer Series Refrigeration

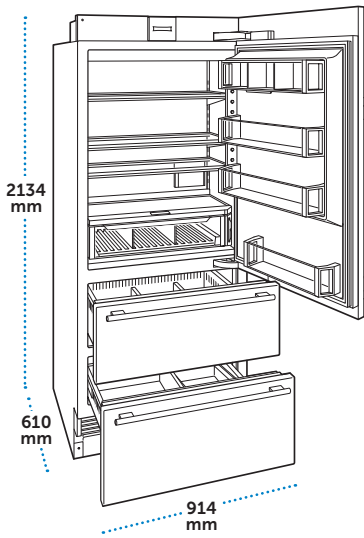

91cm Designer Over-and-Under Refrigerator Freezer with Internal Water Dispenser & Ice Maker

MODEL	COST
ICBDET3650CIID	\$31,999

SPECIFICATIONS

Overall Dimensions	914 mm W x 2134 mm H x 610 mm D
Shipping Weight	209 kg

FEATURES

- Split Climate™ intelligent cooling system
- ClearSight™ LED lighting with Night Mode
- Stainless accents
- 2 temperature zones

Refrigerator

- 3 adjustable glass shelves
- Crisper drawer with dividers
- 1 stationary and 2 adjustable door shelves
- Flip-up dairy compartment
- Air purification system
- Internal water dispenser

Freezer

- 2 full-extension freezer drawers; one with adjustable dividers
- Automatic ice maker with removable ice container
- Water filtration system

Accessories

Stainless Steel Door Panels

DESCRIPTION	NUMBER	COST
2134 mm Finished Height		
Tubular Handle / RH	7023708	\$2,345
Tubular Handle / LH	7023709	\$2,345
Pro Handle / RH	7025314	\$2,340
Pro Handle / LH	7025315	\$2,340

Stainless Steel Drawer Panels (2-panel set)

DESCRIPTION	NUMBER	COST
102 mm Toe Kick		
Tubular Handle	7023704	\$1,850
Pro Handle	7025310	\$1,850

Dual Installation

DESCRIPTION	NUMBER	COST
Dual Installation Kits		
Handle-to-Handle	7027904	\$785
Handle-to-Hinge	7030378	\$785
Hinge-to-Hinge	7030379	\$785
Kickplates		
1372 mm Stainless Steel	7026839	\$180
1524 mm Stainless Steel	7026840	\$210
1676 mm Stainless Steel	7026841	\$235
1829 mm Stainless Steel	7026842	\$235

Filters and Cartridges

DESCRIPTION	NUMBER	COST
Replacement Filter		
Water Filter	4204490	\$180
Replacement Cartridge		
Air Purification	7007067	\$180

Miscellaneous

DESCRIPTION	NUMBER	COST
Enclosure Panel		
Stainless Steel Side (1)	7031340	\$3,115
Mounting Kit		
Drawer Panel Support	7028082	\$65
Reduced Toe Kick Divider	7029956	\$145
Egg Container	7007506	\$110

Designer Series Undercounter Refrigeration

Undercounter Refrigeration

Sub-Zero Designer Series Undercounter Refrigeration features a fully customizable exterior and comes in various functions and configurations—all conveniently sized—to fit wherever you need it most. Add comfort and convenience to your master suite. Create a stunning cocktail bar in your study. Seamlessly integrate a spot for delicate cosmetics. The options are truly endless.

- All models feature a panel ready design.
- Stainless steel accessory panels and handles to coordinate other Sub-Zero, Wolf, and Cove appliances.
- All refrigeration models are Star-K certified.

MODEL NUMBER KEY

International Certified Body (ICB) Approved Model	ICB
Designer Series Undercounter Refrigeration	DEU
All Refrigerator	R
Beverage Center	B
Glass Door	G
Right-Hinge	/R
Left-Hinge	/L

Specify right-hinge (/R) or left-hinge (/L) door when ordering.

Undercounter Models

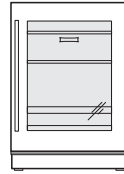

ICBDEU2450BG



ICBDEU2450W

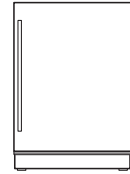

ICBDEU2450R

Drawer Models

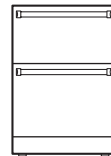

ICBID-24RO

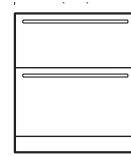

ICBID-30R

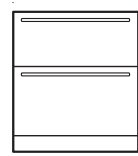

ICBID-30FI

Designer Series Undercounter Refrigeration

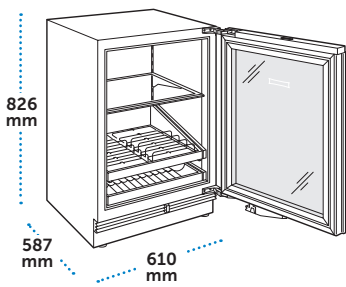

61cm Designer Undercounter Beverage Centre

MODEL	COST
ICBDEU2450BG	\$8,699

SPECIFICATIONS	
Overall Dimensions	610 mm W x 826 mm H x 587 mm D
Shipping Weight	66 kg

FEATURES	
-	1 adjustable glass shelf
-	Spill-proof, nano-coating on glass shelf
-	Full-extended upright beverage shelf with adjustable gates
-	Full-extension multipurpose shelf
-	Full-view, UV-resistant glass door
-	Adjustable LED accent light
-	Espresso interior
-	Door alarm

Accessories

Stainless Steel Door Panels

DESCRIPTION	NUMBER	COST
Tubular Handle / RH	9029034	\$990
Tubular Handle / RH / Lock	9029032	\$1,125
Tubular Handle / LH	9029028	\$1,045
Tubular Handle / LH / Lock	9029026	\$1,125
Pro Handle / RH	9028545	\$1,045
Pro Handle / RH / Lock	9028544	\$1,125
Pro Handle / LH	9028514	\$1,045
Pro Handle / LH / Lock	9028513	\$1,125

Door panel kits include solid stainless steel kickplate, minimum installation height of 864 mm.

Dual Installation

DESCRIPTION	NUMBER	COST
Dual Installation Kits		
Two DEU Units*	9029245	\$360
One DEU with One ID Unit**	9035535	\$360

Stainless Steel Kickplates		
1219 mm	7042655	\$465
1219 mm Tall**	7042680	\$465

*Use when dual installing two undercounter units. Handle to handle installation only.

**Use when dual installing undercounter unit with drawer unit. Handle to hinge installation only.

***Minimum installation height of 876 mm.

Miscellaneous

DESCRIPTION	NUMBER	COST
Stainless Steel Kickplate		
610 mm Tall*	7042677	N/C
Custom Panel Lock Kit	7042232	\$320
Solid Panel-Ready Door RH**	7042312	\$1,245
Solid Panel-Ready Door LH**	7042313	\$1,245

*Minimum installation height of 876 mm.

**Installation requires authorized service.

Designer Series Undercounter Refrigeration

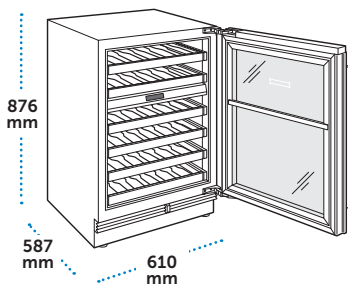

61cm Designer Undercounter Wine Storage

MODEL	COST
ICBDEU2450W	\$11,999

SPECIFICATIONS

Overall Dimensions	610 mm W x 876 mm H x 587 mm D
Design	Undercounter
Wine Storage Capacity	42 bottles (750 ml)
Shipping Weight	80 kg

FEATURES

- 2 temperature zones
- 6 full-extension wine racks
- Full-view, UV-resistant glass door
- Adjustable LED accent light
- Espresso interior
- Door alarm
- Inventory tile system

Accessories

Stainless Steel Door Panels

DESCRIPTION	NUMBER	COST
Tubular Handle / RH	9029034	\$990
Tubular Handle / RH / Lock	9029032	\$1,125
Tubular Handle / LH	9029028	\$1,045
Tubular Handle / LH / Lock	9029026	\$1,125
Pro Handle / RH	9028545	\$1,045
Pro Handle / RH / Lock	9028544	\$1,125
Pro Handle / LH	9028514	\$1,045
Pro Handle / LH / Lock	9028513	\$1,125

Door panel kits include solid stainless steel kickplate, minimum installation height of 864 mm.

Miscellaneous

DESCRIPTION	NUMBER	COST
Stainless Steel Kickplate		
610 mm Tall*	7042677	N/C
Custom Panel Lock Kit	7042232	\$320
Solid Panel-Ready Door RH**	7042312	\$1,245
Solid Panel-Ready Door LH**	7042313	\$1,245

*Minimum installation height of 876 mm.

**Installation requires authorized service.

Accessories

Dual Installation

DESCRIPTION	NUMBER	COST
Dual Installation Kits		
Two DEU Units*	9029245	\$360
One DEU with One ID Unit**	9035535	\$360
Stainless Steel Kickplates		
1219 mm	7042655	\$465
1219 mm Tall***	7042680	\$465

*Use when dual installing two undercounter units. Handle to handle installation only.

**Use when dual installing undercounter unit with drawer unit. Handle to drawer installation only.

***Minimum installation height of 876 mm.

Designer Series Undercounter Refrigeration

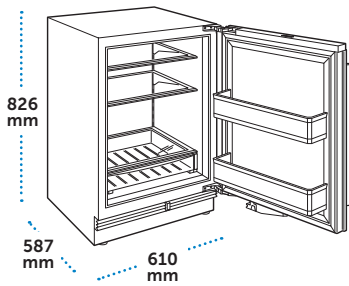

61cm Designer Undercounter Refrigerator

MODEL	COST
ICBDEU2450R	\$7,999

SPECIFICATIONS

Overall Dimensions	610 mm W x 826 mm H x 587 mm D
Shipping Weight	60 kg

FEATURES

- 2 adjustable glass shelves
- 1 fixed glass shelf
- All glass shelves feature a spill-proof, nano-coating
- Clear storage drawer
- 2 door shelves
- White interior
- Door alarm

Accessories

Stainless Steel Door Panels

DESCRIPTION	NUMBER	COST
Tubular Handle / RH	9029035	\$915
Tubular Handle / LH	9029029	\$915
Pro Handle / RH	9029031	\$915
Pro Handle / LH	9029025	\$915

Door panel kits include solid stainless steel kickplate, minimum installation height of 864 mm.

Dual Installation

DESCRIPTION	NUMBER	COST
Dual Installation Kits		
Two DEU Units*	9029245	\$360
One DEU with One ID Unit**	9035535	\$360

Stainless Steel Kickplates

1219 mm	7042655	\$465
1219 mm Tall**	7042680	\$465

*Use when dual installing two undercounter units. Handle to handle installation only.

**Use when dual installing undercounter unit with drawer unit. Handle to hinge installation only.

***Minimum installation height of 876 mm.

Miscellaneous

DESCRIPTION	NUMBER	COST
Stainless Steel Kickplate		
610 mm Tall*	7042677	N/C

*Minimum installation height of 876 mm.

Designer Series Undercounter Refrigeration

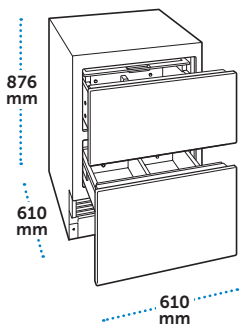

61cm Indoor/Outdoor Refrigerator Drawers

MODEL	COST
ICBID-24RO	\$13,495

SPECIFICATIONS	
Overall Dimensions	610 mm W x 876 mm H x 610 mm D
Shipping Weight	77 kg

FEATURES	
<ul style="list-style-type: none"> - 2 refrigerator storage drawers with dividers - Suitable for indoor and outdoor installations 	

Accessories

Indoor Installation Stainless Steel Drawer Panels (2-panel set)

DESCRIPTION	NUMBER	COST
102 mm Toe Kick		
Tubular Handle	7025408	\$1,595
Pro Handle	7025360	\$1,595
152 mm Toe Kick		
Tubular Handle	7025409	\$1,595
Pro Handle	7025361	\$1,595

Outdoor Installation Stainless Steel Drawer Panels (2-panel set)

DESCRIPTION	NUMBER	COST
102 mm Toe Kick		
Pro Handle (with lock)*	9011615	\$2,640
Pro Handle (without lock)*	9011700	\$2,485

*Required for outdoor installation.

Dual Installation

DESCRIPTION	NUMBER	COST
Dual Installation Kit	7027903	\$530
Kickplates*‡		
1067 mm Stainless Steel	7027399	\$180
1219 mm Stainless Steel	7026838	\$180
1372 mm Stainless Steel	7026839	\$180
1524 mm Stainless Steel	7026840	\$210

*Will accommodate 102 mm and 152 mm toe kick heights.
‡For indoor installation only.

Miscellaneous

DESCRIPTION	NUMBER	COST
Reduced Toe Kick Divider*‡	7029956	\$145
Egg Container	7007506	\$110

*Required for toekicks from 98 mm to 51 mm.
‡For indoor installation only.

Designer Series Undercounter Refrigeration

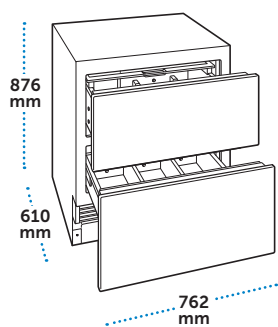

76cm Refrigerator Drawers

MODEL	COST
ICBID-30R	\$15,999

SPECIFICATIONS

Overall Dimensions	762 mm W x 876 mm H x 610 mm D
Shipping Weight	95 kg

FEATURES

- 2 refrigerator storage drawers with dividers
- Sliding crisper cover

Accessories

Stainless Steel Drawer Panels (2-panel set)

DESCRIPTION	NUMBER	COST
102 mm Toe Kick		
Tubular Handle	7023702	\$1,760
Pro Handle	7025308	\$1,760
152 mm Toe Kick		
Tubular Handle	7023703	\$1,760
Pro Handle	7025309	\$1,760

Dual Installation

DESCRIPTION	NUMBER	COST
Dual Installation Kit	7027903	\$530
Kickplates*		
1219 mm Stainless Steel	7026838	\$180
1372 mm Stainless Steel	7026839	\$180
1524 mm Stainless Steel	7026840	\$210
1676 mm Stainless Steel	7026841	\$235

*Will accommodate 102 mm and 152 mm toe kick heights.

Miscellaneous

DESCRIPTION	NUMBER	COST
Mounting Kit		
Drawer Panel Support	7028082	\$65
Reduced Toe Kick Divider*	7029956	\$145
Egg Container	7007506	\$110
Crisper Cover	7025420	\$660

*Required for toekicks from 98 mm to 51 mm.

Designer Series Undercounter Refrigeration

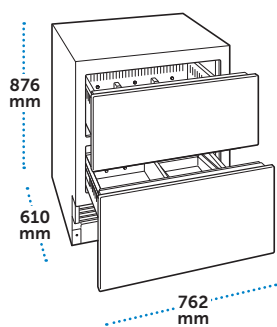

76cm Designer Freezer Drawers with Ice Maker

MODEL	COST
ICBID-30FI	\$14,495

SPECIFICATIONS

Overall Dimensions	762 mm W x 876 mm H x 610 mm D
Shipping Weight	95 kg

FEATURES

- 2 freezer storage drawers with dividers
- Automatic ice maker

Accessories

Stainless Steel Drawer Panels (2-panel set)

DESCRIPTION	NUMBER	COST
102 mm Toe Kick		
Tubular Handle	7023702	\$1,760
Pro Handle	7025308	\$1,760
152 mm Toe Kick		
Tubular Handle	7023703	\$1,760
Pro Handle	7025309	\$1,760

Dual Installation

DESCRIPTION	NUMBER	COST
Dual Installation Kit	7027903	\$530
Kickplates*		
1219 mm Stainless Steel	7026838	\$180
1372 mm Stainless Steel	7026839	\$180
1524 mm Stainless Steel	7026840	\$210
1676 mm Stainless Steel	7026841	\$235

*Will accommodate 102 mm and 152 mm toe kick heights.

Miscellaneous

DESCRIPTION	NUMBER	COST
Mounting Kit		
Drawer Panel Support	7028082	\$65
Reduced Toe Kick Divider*	7029956	\$145

*Required for toekicks from 98 mm to 51 mm.

PRO Series Refrigeration

The only thing more impressive than its bold exterior is the groundbreaking technology and design found inside the reimagined PRO Series. Fitted with the most advanced preservation system, the PRO 48 and PRO 36 continue to fulfill our promise of keeping food fresher longer. Crafted with stainless steel inside and out, it checks all the boxes for those desiring the most luxurious, professional aesthetic. And now in a smaller width, it opens up new design opportunities for small and large kitchens alike. The PRO 36 and PRO 48 are available with or without a glass door and may be either built-in or freestanding.

- Can be used freestanding or installed as a standard or flush built-in application.
- Handles coordinate with Wolf ranges.
- Stainless steel interior and exterior.
- Dual refrigeration system enhanced with dual evaporators allow independent control of storage conditions in refrigerator cabinet and drawer compartments.
- Advanced water filtration and air purification systems.
- Exterior touch control panels.
- Flip-up grille provides easy access for routine maintenance.
- All models are Star-K certified.

MODEL NUMBER KEY

International Certified Body (ICB) Approved Model	ICB
PRO Series Refrigeration	PRO
Glass Door	G
Left-Hinge	-LH
Right-Hinge	-RH

PRO 36 Models

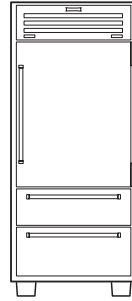

ICBPRO3650

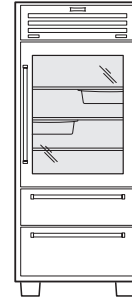

ICBPRO3650G

PRO 48 Models

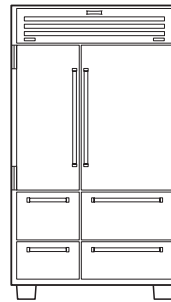

ICBPRO4850

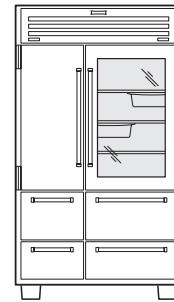

ICBPRO4850G

PRO Series Refrigeration

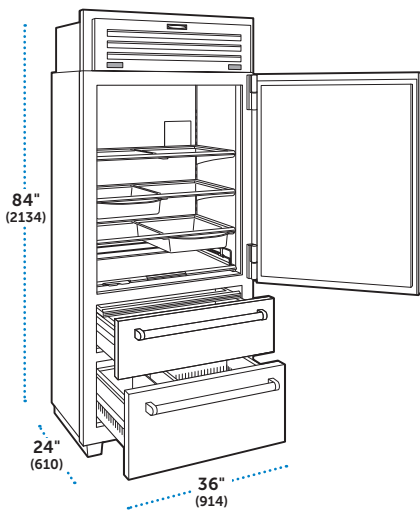

91cm PRO Refrigerator Freezer

MODEL	COST
ICBPRO3650	\$53,495

SPECIFICATIONS

Overall Dimensions	914 mm W x 2134 mm H x 610 mm D
Shipping Weight	286 kg

FEATURES

Refrigerator

- 3 adjustable glass shelves
- 2 stainless steel slide-out bins
- Sliding glass shelf with folding gates
- 1 crisper drawer with cover
- Set of interchangeable drawer dividers
- Air purification system

Freezer

- Automatic ice maker
- Full-extension drawer
- Stainless steel ice bucket
- Water filtration system

Accessories

Stainless Steel Panels

DESCRIPTION	NUMBER	COST
Side Panel	9013058	\$1,935
Top Panel*	9013005	\$660
Kickplate	9013060	\$320

*Requires at least one side panel for proper installation.

Filters and Cartridges

DESCRIPTION	NUMBER	COST
Replacement Filter		
Water Filter	4204490	\$180
Replacement Cartridge		
Air Purification	7007067	\$180

Miscellaneous

DESCRIPTION	NUMBER	COST
Dual Installation Kit*	9029083	\$785
Slide-Out Bin	9013059	\$495
Drawer Divider Set	9018894	\$410
Slide-Out Shelf Gates (2)	9019829	\$235
Egg Container	7007506	\$110
90° Door Stop	0000046	N/C

*Handle-to-handle installation only.

PRO Series Refrigeration

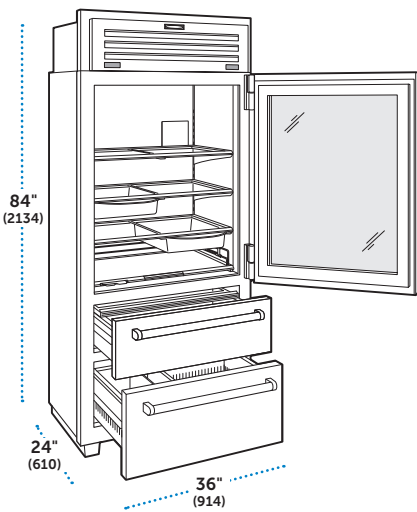

91cm PRO Refrigerator Freezer with Glass Door

MODEL	COST
ICBPRO3650G	\$53,495

SPECIFICATIONS

Overall Dimensions	914 mm W x 2134 mm H x 610 mm D
Shipping Weight	295 kg

FEATURES

Refrigerator

- 3 adjustable glass shelves
- 2 stainless steel slide-out bins
- Sliding glass shelf with folding gates
- 1 crisper drawer
- Crisper cover
- Set of interchangeable drawer dividers
- Triple-pane, UV-resistant glass door
- Air purification system

Freezer

- Automatic ice maker
- Full-extension drawer
- Stainless steel ice bucket
- Water filtration system

Accessories

Stainless Steel Panels

DESCRIPTION	NUMBER	COST
Side Panel	9013058	\$1,935
Top Panel*	9013005	\$660
Kickplate	9013060	\$320

*Requires at least one side panel for proper installation.

Filters and Cartridges

DESCRIPTION	NUMBER	COST
Replacement Filter		
Water Filter	4204490	\$180
Replacement Cartridge		
Air Purification	7007067	\$180

Miscellaneous

DESCRIPTION	NUMBER	COST
Dual Installation Kit*	9029083	\$785
Slide-Out Bin	9013059	\$495
Drawer Divider Set	9018894	\$410
Slide-Out Shelf Gates (2)	9019829	\$235
Egg Container	7007506	\$110
90° Door Stop	0000046	N/C

*Handle-to-handle installation only.

PRO Series Refrigeration

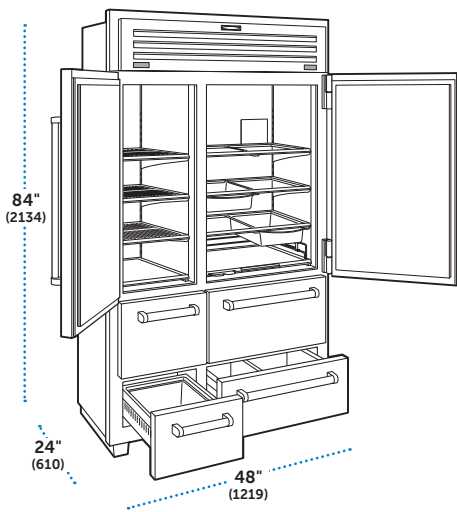

122cm PRO Refrigerator Freezer

MODEL	COST
ICBPRO4850	\$61,999

SPECIFICATIONS

Overall Dimensions	1219 mm W x 2134 mm H x 610 mm D
Shipping Weight	390 kg

FEATURES

Refrigerator

- 3 adjustable glass shelves
- 2 stainless steel slide-out bins
- Sliding glass shelf with folding gates
- 2 storage drawers
- Crisper cover
- Set of interchangeable drawer dividers
- Air purification system

Freezer

- Automatic ice maker
- 3 adjustable stainless steel shelves
- 2 storage drawers
- Stainless steel ice bucket
- Water filtration system

Accessories

Stainless Steel Panels

DESCRIPTION	NUMBER	COST
Side Panel	9013058	\$1,935
Top Panel*	9013057	\$810
Kickplate	9013060	\$320

*Requires at least one side panel for proper installation.

Filters and Cartridges

DESCRIPTION	NUMBER	COST
Replacement Filter		
Water Filter	4204490	\$180
Replacement Cartridge		
Air Purification	7007067	\$180

Miscellaneous

DESCRIPTION	NUMBER	COST
Slide-Out Bin	0000045	\$490
Drawer Divider Set	9018893	\$410
Slide-Out Shelf Gates (2)	9019829	\$235
Egg Container	7007506	\$110
90° Door Stop	0000046	N/C

PRO Series Refrigeration

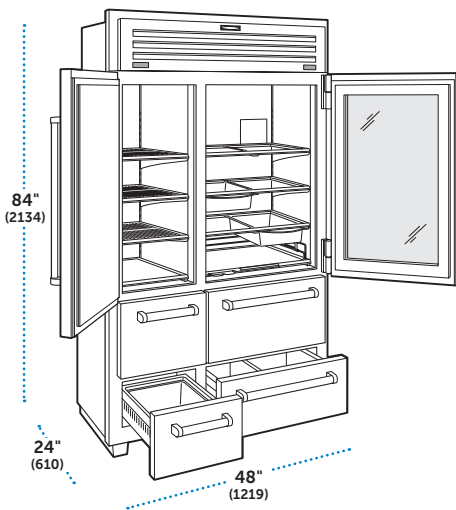

122cm PRO Refrigerator Freezer with Glass Door

MODEL	COST
ICBPRO4850G	\$61,999

SPECIFICATIONS

Overall Dimensions	1219 mm W x 2134 mm H x 610 mm D
Shipping Weight	399 kg

FEATURES

Refrigerator

- 3 adjustable glass shelves
- 2 stainless steel slide-out bins
- Sliding glass shelf with folding gates
- 2 storage drawers
- Crisper cover
- Set of interchangeable drawer dividers
- Triple-pane, UV-resistant glass door
- Air purification system

Freezer

- Automatic ice maker
- 3 adjustable stainless steel shelves
- 2 storage drawers
- Stainless steel ice bucket
- Water filtration system

Accessories

Stainless Steel Panels

DESCRIPTION	NUMBER	COST
Side Panel	9013058	\$1,935
Top Panel*	9013057	\$810
Kickplate	9013060	\$320

*Requires at least one side panel for proper installation.

Filters and Cartridges

DESCRIPTION	NUMBER	COST
Replacement Filter		
Water Filter	4204490	\$180
Replacement Cartridge		
Air Purification	7007067	\$180

Miscellaneous

DESCRIPTION	NUMBER	COST
Slide-Out Bin	0000045	\$490
Drawer Divider Set	9018893	\$410
Slide-Out Shelf Gates (2)	9019829	\$235
Egg Container	7007506	\$110
90° Door Stop	0000046	N/C

Wine Storage

To preserve the integrity of every glass, Sub-Zero Wine Storage units are more than just coolers; they are built with advanced preservation technologies and protective features that guard against the harmful effects of heat, humidity, light, and vibration. Cherrywood-faced shelves, soft lighting, custom cabinetry if desired—Sub-Zero helps make a wine collection an element of beauty in the home.

- Overlay, flush inset, stainless steel, and integrated design options complement Classic Series, Designer Series, Designer Undercounter units for dual installation.
- Full-view glass door on all models.
- Discreet interior lighting with illuminated display shelf.
- Two independent storage zones maintain temperature, humidity, and UV protection.
- Cherrywood-faced shelves display the wine beautifully and accommodate 750 ml bottles, half-bottles, and magnums.

MODEL NUMBER KEY

International Certified Body (ICB) Approved Model	ICB
Classic Series	CL
Designer Series Column	DEC
Designer Series Tall	DET
Wine Storage	W
Refrigerator Drawers	R
Overlay Model	/O
Stainless Steel Model	/S
Tubular Handle	/T
Pro Handle	/P
Right-Hinge	/R
Left-Hinge	/L

Models are shown in the stainless steel design with tubular handles.

Specify right-hinge (/R) or left-hinge (/L) door when ordering.

Overall dimensions for ICBCL3050W are based on stainless steel models. Overall dimensions for Designer Series full size models do not include panels or handles. Dimensions will vary with panel thickness.

Wine Storage Models

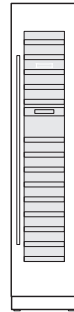

ICBDEC1850W



ICBDEC2450W



ICBDEC3050W

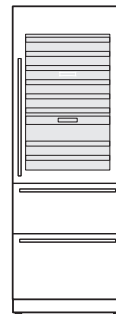

ICBDET3050WR



ICBCL3050W

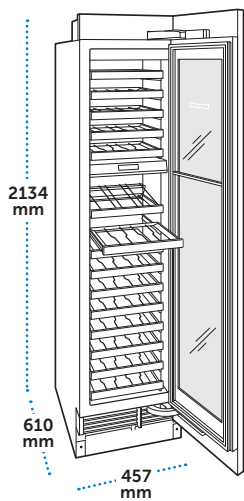

NEW

46cm Designer Wine Storage - Custom Panel Ready

MODEL	COST
ICBDEC1850W	\$20,999

SPECIFICATIONS

Overall Dimensions	457 mm W x 2134 mm H x 610 mm D
Design	Designer Series
Wine Storage Capacity	59 bottles (750 ml)
Shipping Weight	159 kg

FEATURES

- 2 temperature zones
- 5 upper and 10 lower compartment shelves
- Full-view, UV-resistant glass door
- Inventory tile system

Accessories

Stainless Steel Door Panels

DESCRIPTION	NUMBER	COST
2134 mm Fin Height – 102 mm Toe Kick		
Tubular Handle / RH	7025376	\$1,960
Tubular Handle / RH / Lock	7025380	\$2,310
Tubular Handle / LH	7025377	\$1,960
Tubular Handle / LH / Lock	7025381	\$2,310
Pro Handle / RH	7025328	\$1,960
Pro Handle / RH / Lock	7025332	\$2,310
Pro Handle / LH	7025329	\$1,960
Pro Handle / LH / Lock	7025333	\$2,310

Dual Installation

DESCRIPTION	NUMBER	COST
Dual Installation Kits		
Handle-to-Handle	7027904	\$785
Handle-to-Hinge	7030378	\$785
Hinge-to-Hinge	7030379	\$785
Kickplates		
914 mm Stainless Steel	7026837	\$180
1067 mm Stainless Steel	7027399	\$180
1219 mm Stainless Steel	7026838	\$180
1372 mm Stainless Steel	7026839	\$180

Miscellaneous

DESCRIPTION	NUMBER	COST
Enclosure Panel		
Stainless Steel Side (1)	7031340	\$3,115
Reduced Toe Kick Divider	7029956	\$145
Solid Panel-Ready Door RH*	7031923	\$1,510
Solid Panel-Ready Door LH*	7031924	\$1,510
Lock Kit	7028773	\$320
Inventory Tiles (15)	7031944	\$110
Inventory Tiles / Writable (15)	7030331	\$180
Bulk Storage Drawer	7028448	\$1,510
Dessert Wine Rack	7028451	\$1,190

*Installation may require authorized service.

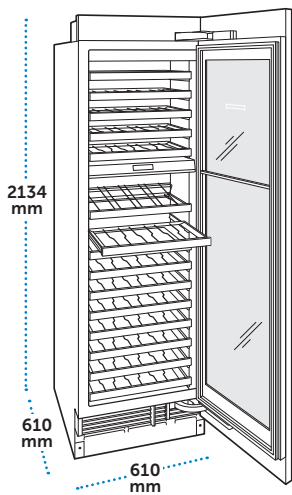

NEW

61cm Designer Wine Storage - Custom Panel Ready

MODEL	COST
ICBDEC2450W	\$21,999

SPECIFICATIONS

Overall Dimensions	610 mm W x 2134 mm H x 610 mm D
Design	Designer Series
Wine Storage Capacity	102 bottles (750 ml)
Shipping Weight	186 kg

FEATURES

- 2 temperature zones
- 5 upper and 10 lower compartment shelves
- Full-view, UV-resistant glass door
- Inventory tile system

Accessories

Stainless Steel Door Panels

DESCRIPTION	NUMBER	COST
2134 mm Fin Height – 102 mm Toe Kick		
Tubular Handle / RH	7025384	\$2,260
Tubular Handle / RH / Lock	7025388	\$2,630
Tubular Handle / LH	7025385	\$2,345
Tubular Handle / LH / Lock	7025389	\$2,630
Pro Handle / RH	7025336	\$2,345
Pro Handle / RH / Lock	7025340	\$2,630
Pro Handle / LH	7025337	\$2,345
Pro Handle / LH / Lock	7025341	\$2,630

Dual Installation

DESCRIPTION	NUMBER	COST
Dual Installation Kits		
Handle-to-Handle	7027904	\$785
Handle-to-Hinge	7030378	\$785
Hinge-to-Hinge	7030379	\$785
Kickplates		
1067 mm Stainless Steel	7027399	\$180
1219 mm Stainless Steel	7026838	\$180
1372 mm Stainless Steel	7026839	\$180
1524 mm Stainless Steel	7026840	\$210

Miscellaneous

DESCRIPTION	NUMBER	COST
Enclosure Panels		
Stainless Steel Side (1)	7031340	\$3,115
Reduced Toe Kick Divider	7029956	\$145
Solid Panel-Ready Door RH*	7031925	\$1,620
Solid Panel-Ready Door LH*	7031926	\$1,620
Lock Kit	7028773	\$320
Inventory Tiles (15)	7031944	\$110
Inventory Tiles / Writable (15)	7030331	\$180
Bulk Storage Drawer	7028449	\$1,760
Dessert Wine Rack	7028451	\$1,190

*Installation may require authorized service.

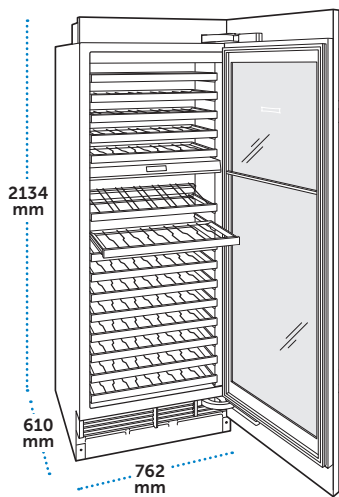

NEW

76cm Designer Wine Storage - Custom Panel Ready

MODEL	COST
ICBDEC3050W	\$25,999

SPECIFICATIONS

Overall Dimensions	762 mm W x 2134 mm H x 610 mm D
Design	Designer Series
Wine Storage Capacity	146 bottles (750 ml)
Shipping Weight	209 kg

FEATURES

- 2 temperature zones
- 5 upper and 10 lower compartment shelves
- Full-view, UV-resistant glass door
- Inventory tile system

Accessories

Stainless Steel Door Panels

DESCRIPTION	NUMBER	COST
2134 mm Fin Height – 102 mm Toe Kick		
Tubular Handle / RH	7025392	\$2,565
Tubular Handle / RH / Lock	7025396	\$2,970
Tubular Handle / LH	7025393	\$2,640
Tubular Handle / LH / Lock	7025397	\$2,970
Pro Handle / RH	7025344	\$2,640
Pro Handle / RH / Lock	7025348	\$2,970
Pro Handle / LH	7025345	\$2,640
Pro Handle / LH / Lock	7025349	\$2,970

Dual Installation

DESCRIPTION	NUMBER	COST
Dual Installation Kits		
Handle-to-Handle	7027904	\$785
Handle-to-Hinge	7030378	\$785
Hinge-to-Hinge	7030379	\$785
Kickplates		
1219 mm Stainless Steel	7026838	\$180
1372 mm Stainless Steel	7026839	\$180
1524 mm Stainless Steel	7026840	\$210
1676 mm Stainless Steel	7026841	\$235

Miscellaneous

DESCRIPTION	NUMBER	COST
Enclosure Panels		
Stainless Steel Side (1)	7031340	\$3,115
Reduced Toe Kick Divider	7029956	\$145
Solid Panel-Ready Door RH*	7031927	\$1,705
Solid Panel-Ready Door LH*	7031928	\$1,705
Lock Kit	7028773	\$320
Inventory Tiles (15)	7031944	\$110
Inventory Tiles / Writable (15)	7030331	\$180
Bulk Storage Drawer	7028450	\$2,155
Dessert Wine Rack	7028451	\$1,190

*Installation may require authorized service.

Wine Storage

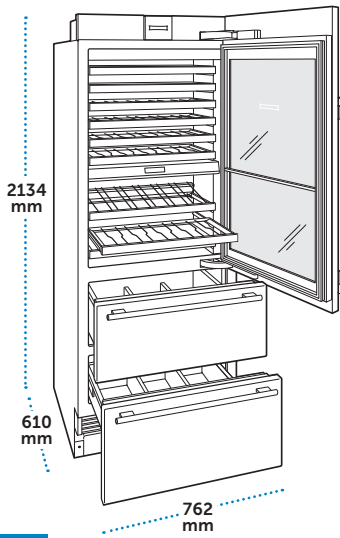

76cm Designer Wine Storage with Refrigerator Drawers

MODEL	COST
ICBDET3050WR	\$29,999

SPECIFICATIONS

Overall Dimensions	762 mm W x 2134 mm H x 610 mm D
Design	Designer Series
Wine Storage Capacity	86 bottles (750 ml)
Shipping Weight	222 kg

FEATURES

- 3 temperature zones
- 6 upper and 3 lower compartment shelves
- Display shelf
- Full-view, UV-resistant glass door
- 2 refrigerator drawers with dividers

Accessories

Stainless Steel Door Panels

DESCRIPTION	NUMBER	COST
2134 mm Finished Height		
Tubular Handle / RH	7025400	\$2,345
Tubular Handle / RH / Lock	7025402	\$2,630
Tubular Handle / LH	7025401	\$2,345
Tubular Handle / LH / Lock	7025403	\$2,630
Pro Handle / RH	7025352	\$2,345
Pro Handle / RH / Lock	7025354	\$2,630
Pro Handle / LH	7025353	\$2,345
Pro Handle / LH / Lock	7025355	\$2,630

Stainless Steel Drawer Panels (2-panel set)

DESCRIPTION	NUMBER	COST
102 mm Toe Kick		
Tubular Handle	7023702	\$1,760
Pro Handle	7025308	\$1,760

Dual Installation

DESCRIPTION	NUMBER	COST
Dual Installation Kits		
Handle-to-Handle	7027904	\$785
Handle-to-Hinge	7030378	\$785
Hinge-to-Hinge	7030379	\$785

Kickplates

1219 mm Stainless Steel	7026838	\$180
1372 mm Stainless Steel	7026839	\$180
1524 mm Stainless Steel	7026840	\$210
1676 mm Stainless Steel	7026841	\$235

Miscellaneous

DESCRIPTION	NUMBER	COST
Enclosure Panel		
Stainless Steel Side (1)	7031340	\$3,115
Mounting Kit		
Drawer Panel Support	7028082	\$65
Reduced Toe Kick Divider	7029956	\$145
Solid Panel-Ready Door RH*	7031929	\$1,475
Solid Panel-Ready Door LH*	7031930	\$1,475
Lock Kit	7028773	\$320
Inventory Tiles (15)	7031944	\$110
Inventory Tiles / Writable (15)	7030331	\$180
Bulk Storage Drawer	7028450	\$2,155
Dessert Wine Rack	7028451	\$1,190

*Installation may require authorized service.

Wine Storage

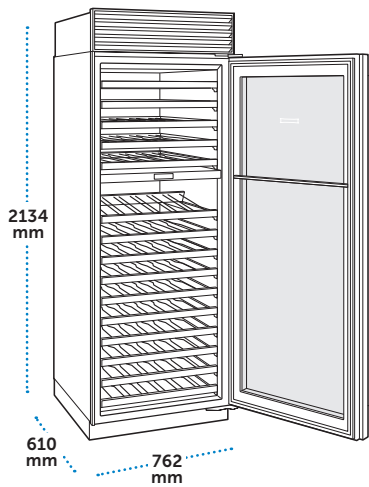

NEW

76cm Classic Wine Storage - Custom Panel Ready

MODEL	COST
ICBCL3050W/O	\$26,999
ICBCL3050W/S/T	\$30,495
ICBCL3050W/S/P	\$30,495

SPECIFICATIONS

Overall Dimensions	762 mm W x 2134 mm H x 610 mm D
Design	Classic Series
Wine Storage Capacity	146 bottles (750 ml)
Shipping Weight	215 kg

FEATURES

- 2 temperature zones
- 5 upper and 9 lower compartment shelves
- Display shelf
- Full-view, UV-resistant glass door

No solid door option available for this model.

Accessories

Grilles

FINISHED HEIGHT	NUMBER	COST
Overlay or Flush Inset		
2134 mm Grille Frame	9044751	\$745
Stainless Steel		
2134 mm Pro Louvered	9044755	\$1,335

Accessories

Dual Installation Kit

DESCRIPTION	NUMBER	COST
All Designs		
Dual Installation Kit	9040597	\$1,155

For handle-to-handle installations only. Kit includes center trim strip, heater and mounting hardware.

Dual Installation Kit with Dual Wide Grille

DESCRIPTION	NUMBER	COST
Stainless Steel		
1524 mm Pro Louvered	9040594	\$3,670
1676 mm Pro Louvered	9040595	\$3,840

For handle-to-handle installations only. Kit includes dual wide kickplate and dual wide grille for 2134 mm finished height, center trim strip, heater and mounting hardware.

Single Flush Inset – Stainless Steel

DESCRIPTION	NUMBER	COST
Grilles		
2134 mm Solid SS	9038231	\$670
2134 mm Pro Louvered	9045093	\$1,030
Door Panels		
Pro Handle	9038447	\$2,775
Tubular Handle	9038448	\$2,775

Miscellaneous

DESCRIPTION	NUMBER	COST
Mounting Kits		
Custom Side Panel	7003407	\$375
Side Panels		
Stainless Steel (1)	9044759	\$2,325
Kickplates		
Stainless Steel RH	9038627	\$155
Stainless Steel LH	9038628	\$155
Lock Kit	9040598	\$670
90° Door Stop	7005865	N/C
Inventory Tiles (15)	7031944	\$110
Inventory Tiles / Writable (15)	7030331	\$180
Bulk Storage Drawer	9038248	\$2,375
Dessert Wine Rack	7040428	\$1,020

Accessory Handles

Stainless Steel Handles

Tubular Handles (Square Standoffs)

DESCRIPTION	NUMBER	COST
19 mm Diameter		
572 mm	9036005	\$510
692 mm	7025229	\$510
845 mm	7025228	\$510
1273 mm	7025227	\$585
25 mm Diameter		
635 mm	9042359	\$510
787 mm	9042361	\$510
940 mm	9042362	\$510
1019 mm	9042356	\$510
1092 mm	9042364	\$510
1543 mm	9042354	\$585

Pro Handles

DESCRIPTION	NUMBER	COST
572 mm	9036003	\$510
610 mm	9042357	\$510
648 mm	7026117	\$510
762 mm	9042360	\$510
800 mm	7026116	\$510
916 mm	9042355	\$510
1067 mm	9042363	\$510
1229 mm	7026115	\$585
1440 mm	9042353	\$585

Standard Handle Length

MODEL	TUBULAR	PRO
Classic Series		
Full Door	1543 mm	1440 mm
Over-and-Under Door	1019 mm	916 mm
762 mm Drawer	635 mm	610 mm
914 mm Drawer	787 mm	762 mm
1067 mm Drawer	940 mm	916 mm
1219 mm Drawer	1092 mm	1067 mm
Designer Series		
Column Door	1273 mm	1229 mm
Tall Door	845 mm	800 mm
914 mm Drawer	845 mm	800 mm
762 mm Drawer	692 mm	648 mm
Wine Storage		
ICBCL3050W Door	1543 mm	1440 mm
ICBDEC1850W, ICBDEC2450W, ICBDEC3050W Door	1273 mm	1229 mm
ICBDET3050WR Door	845 mm	800 mm
ICBDET3050WR Drawer	692 mm	648 mm
Designer Series Undercounter		
ICBDEU2450BG, ICBDEU2450R	572 mm	572 mm

Warranty Information

Sub-Zero International Limited Warranty

FOR RESIDENTIAL USE

FULL TWO YEAR WARRANTY*

For two years from the date of original installation, this Sub-Zero product warranty covers all parts and labor to repair or replace, under normal residential use, any part of the product that proves to be defective in materials or workmanship. All service provided by Sub-Zero under the above warranty must be performed by Sub-Zero Factory Certified Service, unless otherwise specified by Sub-Zero, Inc. Service will be provided during normal business hours.

FULL FIVE YEAR SEALED SYSTEM WARRANTY

For five years from the date of original installation, this Sub-Zero product warranty covers all parts and labor to repair or replace, under normal residential use, these parts that prove to be defective in materials or workmanship: compressor, condenser, evaporator, drier and all connecting tubing. All service provided by Sub-Zero under the above warranty must be performed by Sub-Zero Factory Certified Service, unless otherwise specified by Sub-Zero, Inc. Service will be provided during normal business hours.

TERMS APPLICABLE TO EACH WARRANTY

The warranty applies only to products installed for normal residential use. This warranty does not cover any parts or labor to correct any defect caused by negligence, accident or improper use, maintenance, installation, service or repair.

THE REMEDIES DESCRIBED ABOVE FOR EACH WARRANTY ARE THE ONLY ONES THAT SUB-ZERO, INC. WILL PROVIDE, EITHER UNDER THIS WARRANTY OR UNDER ANY WARRANTY ARISING BY OPERATION OF LAW. SUB-ZERO, INC. WILL NOT BE RESPONSIBLE FOR ANY CONSEQUENTIAL OR INCIDENTAL DAMAGES ARISING FROM THE BREACH OF THIS WARRANTY OR ANY OTHER WARRANTY, WHETHER EXPRESS, IMPLIED OR STATUTORY.

For more information regarding your Sub-Zero product warranty, contact your authorized Sub-Zero dealer. Warranties must comply to all country, state, city, local and or ordinance.

*Stainless steel (doors, panels, handles, product frames and interior surfaces) are covered by a limited 60-day parts and labor warranty for cosmetic defects.

*Replacement water filters and air purification cartridges are not covered by the product warranty.



Warranty Information

Sub-Zero International Outdoor Limited Warranty*

FOR RESIDENTIAL USE

FULL ONE YEAR WARRANTY**

For one year from the date of original installation, this Sub-Zero product warranty covers all parts and labor to repair or replace, under normal residential use, any part of the product that proves to be defective in materials or workmanship. All service provided by Sub-Zero under the above warranty must be performed by Sub-Zero Factory Certified Service, unless otherwise specified by Sub-Zero, Inc. Service will be provided during normal business hours.

FULL FIVE YEAR SEALED SYSTEM WARRANTY

For five years from the date of original installation, this Sub-Zero product warranty covers all parts and labor to repair or replace, under normal residential use, these parts that prove to be defective in materials or workmanship: compressor, condenser, evaporator, drier and all connecting tubing. All service provided by Sub-Zero under the above warranty must be performed by Sub-Zero Factory Certified Service, unless otherwise specified by Sub-Zero, Inc. Service will be provided during normal business hours.

TERMS APPLICABLE TO EACH WARRANTY

The warranty applies only to products installed for normal residential use. This warranty does not cover any parts or labor to correct any defect caused by negligence, accident or improper use, maintenance, installation, service or repair.

THE REMEDIES DESCRIBED ABOVE FOR EACH WARRANTY ARE THE ONLY ONES THAT SUB-ZERO, INC. WILL PROVIDE, EITHER UNDER THIS WARRANTY OR UNDER ANY WARRANTY ARISING BY OPERATION OF LAW. SUB-ZERO, INC. WILL NOT BE RESPONSIBLE FOR ANY CONSEQUENTIAL OR INCIDENTAL DAMAGES ARISING FROM THE BREACH OF THIS WARRANTY OR ANY OTHER WARRANTY, WHETHER EXPRESS, IMPLIED OR STATUTORY.

For more information regarding your Sub-Zero product warranty, contact your dealer. Warranties must comply to all country, state, city, local and or ordinance.

*Product must be approved for outdoor use, designated by model and serial number.

**Stainless steel (doors, panels, handles, product frames and interior surfaces) are covered by a limited 60-day parts and labor warranty for cosmetic defects.

**Replacement water filters and air purification cartridges are not covered by the product warranty.



Warranty Information

Sub-Zero International Display Products Limited Warranty*

FOR RESIDENTIAL USE

FULL ONE YEAR WARRANTY**

For one year from the date of original installation, this Sub-Zero product warranty covers all parts and labor to repair or replace, under normal residential use, any part of the product that proves to be defective in materials or workmanship. All decisions whether to repair or replace will be made by Sub-Zero, Inc. Cosmetic defects are not covered by the product warranty. All service provided by Sub-Zero under the above warranty must be performed by Sub-Zero Factory Certified Service, unless otherwise specified by Sub-Zero, Inc. Service will be provided during normal business hours.

LIMITED FIVE YEAR SEALED SYSTEM WARRANTY

For five years from the date of original installation, Sub-Zero will repair or replace the following parts that prove to be defective in materials or workmanship: compressor, condenser, evaporator, drier and all connecting tubing. If the owner uses Sub-Zero Factory Certified Service, the service provider will repair or replace these parts with the owner paying for all other costs, including labor. If the owner uses non-certified service, the owner must contact Sub-Zero, Inc. (using the information below) to receive repaired or replacement parts. Sub-Zero will not reimburse the owner for parts purchased from non-certified service or other sources.

TERMS APPLICABLE TO EACH WARRANTY

This warranty does not cover any parts or labor to correct any defect caused by negligence, accident or improper use, maintenance, installation, service or repair.

THE REMEDIES DESCRIBED ABOVE FOR EACH WARRANTY ARE THE ONLY ONES THAT SUB-ZERO, INC. WILL PROVIDE, EITHER UNDER THIS WARRANTY OR UNDER ANY WARRANTY ARISING BY OPERATION OF LAW. SUB-ZERO, INC. WILL NOT IN ANY EVENT BE RESPONSIBLE FOR ANY CONSEQUENTIAL OR INCIDENTAL DAMAGES.

For more information regarding your Sub-Zero product warranty, contact your authorized Sub-Zero dealer. Warranties must comply to all country, state, city, local and or ordinance.

*Applies to display products sold more than three years from the invoice date.

**Replacement water filters and air purification cartridges are not covered by the product warranty.



Warranty Information

Sub-Zero International Non-Residential Limited Warranty

FOR NON-RESIDENTIAL USE

FULL ONE YEAR WARRANTY*

For one year from the date of original installation, this Sub-Zero product warranty covers all parts and labor to repair or replace, under normal use, any part of the product that proves to be defective in materials or workmanship. All service provided by Sub-Zero under the above warranty must be performed by Sub-Zero Factory Certified Service, unless otherwise specified by Sub-Zero, Inc. Service will be provided during normal business hours.

LIMITED FIVE YEAR SEALED SYSTEM WARRANTY

For five years from the date of original installation, Sub-Zero will repair or replace the following parts that prove to be defective in materials or workmanship: compressor, condenser, evaporator, drier and all connecting tubing. If the owner uses Sub-Zero Factory Certified Service, the service provider will repair or replace these parts with the owner paying for all other costs, including labor. If the owner uses non-certified service, the owner must contact Sub-Zero, Inc. (using the information below) to receive repaired or replacement parts. Sub-Zero will not reimburse the owner for parts purchased from non-certified service or other sources.

TERMS APPLICABLE TO EACH WARRANTY

This warranty does not cover any parts or labor to correct any defect caused by negligence, accident or improper use, maintenance, installation, service or repair.

THE REMEDIES DESCRIBED ABOVE FOR EACH WARRANTY ARE THE ONLY ONES THAT SUB-ZERO, INC. WILL PROVIDE, EITHER UNDER THIS WARRANTY OR UNDER ANY WARRANTY ARISING BY OPERATION OF LAW. SUB-ZERO, INC. WILL NOT BE RESPONSIBLE FOR ANY CONSEQUENTIAL OR INCIDENTAL DAMAGES ARISING FROM THE BREACH OF THIS WARRANTY OR ANY OTHER WARRANTY, WHETHER EXPRESS, IMPLIED OR STATUTORY.

For more information regarding your Sub-Zero product warranty, contact your authorized Sub-Zero dealer. Warranties must comply to all country, state, city, local and or ordinance.

*Stainless steel (doors, panels, handles, product frames and interior surfaces) are covered by a limited 60-day parts and labor warranty for cosmetic defects.

*Replacement water filters and air purification cartridges are not covered by the product warranty.



20

22

