

# Zip HydroTap for the workplace



PURE-TASTING | INSTANT | **BOILING** | CHILLED | SPARKLING



POWERED BY  
**G5**  
TECHNOLOGY

Water at its best



Introduction	2
Water at its best	3
Classic Plus	7
Touch-Free Wave	8
Zip Micro	9
UltraCare	10
G5 technology	11
Filtration technology	13
Healthier workplace	14
Widest range and finishes	15
Environmental product declaration	17
Safe and accessible	19
Zip service difference	20
Zip innovation history timeline	21

HydroTap Classic range	
Touch-Free Wave	25
Touch-Free Wave with Mixer	26
Classic Plus	27
Classic Plus with Mixer	28
Classic	29
Classic with Mixer	30
Classic All-In-One	31
Classic Industrial	32
Classic for accessibility	33

HydroTap Design range	
Arc Plus	35
Arc Plus with Mixer	36
Cube Plus	37
Cube Plus with Mixer	38
Elite Plus	39
Elite Plus with Mixer	40

HydroTap Celsius range	
Celsius All-In-One	42
Celsius Arc	43
Celsius Cube	44
Micro	45

Technical data	
Classic Plus	46
Touch-Free Wave	48
Classic	50
Industrial	52
UltraCare	52
Arc Plus	53
Cube Plus	54
Elite Plus	55
Celsius All-In-One	57
Celsius Arc	57
Celsius Cube	57
Technical information	58

Consumables and accessories	
Accessories	60
Installation accessories	61
HydroTap filters and CO <sub>2</sub>	61



75  
CELEBRATING  
1947-2022

## 75 years of innovation

As we mark our 75th anniversary, we are thrilled to share with you our latest technology. With unrivalled expertise in instant filtered boiling, chilled and sparkling water, Zip Water is known globally for being home to the Zip HydroTap, which dispenses pure-tasting water at the touch of a button.

Founded in Australia in 1947, we've always been innovators, advancing and perfecting our drinking water technology for decades. Today, we're proud to provide workplaces, in over 70 countries across the world with the purest tasting water possible from our range of Zip HydroTaps.

Access the latest water filtration technology for pure-tasting water. Convenience at the touch of a button for instant boiled, chilled and sparkling water. Stylish designs and finishes to suit any kitchen and declutter bench space for efficiency.

Start drinking more, saving time, saving energy and seeing the benefits to your family's wellbeing from your very first glass.

Welcome to the Zip HydroTap family. We thank you for your support as we embark on another 75 years of delivering water at its best.

John Doumani, President Zip Industries

Featured product  
HydroTap Classic Plus in Chrome finish



# Experience water at its best with Zip HydroTap

## Convenience of instant pure-tasting water at the touch of a button

Enjoy pure-tasting boiling, chilled and sparkling water flowing from the simplest of touches with the Zip HydroTap G5. With sleek design and slick function powered by our most advanced technology, the HydroTap G5 has more personalised settings and features SteriTouch® for enhanced hygiene. It's not just water, it's water at its best.



FILTERED  
BOILING



FILTERED  
CHILLED



FILTERED  
SPARKLING



FILTERED  
AMBIENT



UNFILTERED  
HOT & COLD



POWERED BY  
**G5**  
TECHNOLOGY

# Powered by our latest G5 technology

Zip HydroTap's superior filtration and compact, efficient design makes it the perfect water solution for any workspace.

Remove kettles from your benchtops. Eliminate refrigerated bottles of still and sparkling water. Save space, energy and money. Forget deliveries and storage of water cooler bottles.

The Zip HydroTap is a convenient and practical way to offer your staff, customers and visitors fresh, pure-tasting water – instantly and safely.

# Experience water at its best with HydroTap in the workplace

Pure-tasting boiling, chilled and sparkling water in an instant, delivered seamlessly with a Zip HydroTap. There is a HydroTap to suit any workplace.

## For the office workplace

Workplace productivity and wellbeing is vital to every team environment. Zip HydroTap meets all your workplace water needs, in one elegant, easy-to-use system, using the latest technology to keep up with a busy workplace. Introducing our latest addition to our flagship HydroTap range - Classic Plus.



## For touch-free workplaces

With an increased consideration around hygiene in the workplace, Zip HydroTap Touch-Free Wave provides a 100% touch-free solution to instantly dispense pure-tasting drinking water with a simple wave of a hand.



## For the small workplace

Award winning Zip Micro is our smallest ever drinking water system, designed to fit under almost any bench and keeps up to 10 people hydrated – the perfect solution for smaller offices.



## For health and aged care facilities

For health and aged care facilities, HydroTap UltraCare is proven to deliver a 99.9% reduction in Legionella\*.



\*ALS Pty Ltd Testing of the Zip HydroTap UltraCare system efficacy tests



# Zip HydroTap certified installation

For professional results, let Zip Water take care of the installation. Our skilled service technicians will install and set up your HydroTap so you can start enjoying instant pure-tasting water as soon as possible.

## Experienced & certified installers

As certified installation specialists, we will install your new HydroTap including stone cutting for tap and/or font installations\*.

## Full national coverage

With more than 100 Zip certified technicians and 350 authorised service providers across the country, Zip Water can ensure coverage for your installation and service needs.

## Experts in residential installation

Access our certified installation team, experienced in navigating around residential kitchens and equipped with all necessary tools to complete your HydroTap installation\*.

## Product demonstration

Zip HydroTap certified installation includes a product demonstration to show how to get the most out of your new HydroTap system and answer any questions you may have.

## High customer satisfaction

We strive to deliver exceptional customer service and take pride in our customer satisfaction. 80% of our customers have rated our Zip Water service technicians 9 or 10/10 demonstrating our commitment to you, our customers.

\*Installation service is available in Australian metro areas only where suitable power and water are available within 1 metre of the installation location. Installation must be within 70 kilometres of metro areas. Includes stone cutting for tap and/or font installation but excludes cutting of fixtures or major plumbing modifications. \*Zip Water Service Net Promoter Survey, Feb 21-Feb 22.

## Arrange a Zip HydroTap certified installation



Add installation to your order when visiting your nearest retailer



Purchase directly at [zipwater.com/hydrotap-installation](https://zipwater.com/hydrotap-installation)



# Say hello to Classic Plus & Elite Plus

Enjoy pure-tasting boiling, chilled and sparkling water instantly with Zip HydroTap, powered by our most advanced G5 technology.

## Sleek design meets slick function

With simple, intuitive controls including continuous flow to fill bottles and coming in seven ultra-modern finishes, HydroTap Classic Plus and Elite Plus will add designer style to any kitchen.

## Smarter and more personalised

Create your preferred settings with a few touches using the optimised new menu in the HydroTap G5 command centre. Select energy modes and usage settings for easier customisation.

## Setting the hygiene standard

Zip HydroTap G5 has SteriTouch® antimicrobial protection impregnated within key water surfaces as well as on the new touch-pad for enhanced hygiene.



Classic Plus

Elite Plus



Classic Plus - 2021 Accolade Winner  
in the Product Design Domestic Appliances category in recognition for outstanding design and innovation.



# The evolution of Arc Plus and Cube Plus

Elevate any kitchen with HydroTap Arc Plus and Cube Plus, our latest addition to the Zip HydroTap range.

## Sophisticated elegance

HydroTap Arc Plus and Cube Plus will add a stylish finish to all kitchens with its designer silhouette, balancing the on-trend tap styles with our G5 technology to deliver boiling, chilled and sparkling water on demand.

## Instant refreshments

Enjoy access to perfect refreshments with pure-tasting water at the press of a button. HydroTap Arc Plus and Cube Plus offers enhanced sparkling & chilled water delivery with the optimised aerator hidden inside the elegant spout of the tap.



Arc Plus

Cube Plus

Available in 7 ultra-modern finishes to suit any designer kitchen.





# Create a safer workplace with HydroTap Touch-Free Wave

Available in Chrome and Matte Black



Introducing Zip HydroTap Touch-Free Wave, with smart infrared sensors that activate boiling, chilled and sparkling water.

With an increased consideration around hygiene in the workplace, new Zip HydroTap Touch-Free Wave provides a 100% touch-free solution to instantly dispense pure-tasting drinking water with a simple wave of a hand.

## How it works

- Infrared smart sensors detect hand movements within 1.5 - 5cm in range of the tap
- Once the hand moves away, the water flow will stop
- All drinking water types will have a maximum run time of 15 seconds which is adjustable from the command centre
- Continuous flow to fill bottles with twin sensor activation



View how to operate Touch-Free Wave

## Safety features

- Twin sensor activation for safe delivery of boiling water



- Dispensing will deactivate when the tap is touched or grabbed, allowing for safe cleaning



Wave right for chilled



Wave above for sparkling



Twin sensor activation for boiling



Infrared sensor



Touch-free activation



1.5-5cm sensor range



Deactivates when touched



2021 Accolade Winner

in the Product Design Domestic Appliances category in recognition for outstanding design and innovation.

# Zip Micro, our smallest ever drinking water system



**37%\***  
narrower  
to fit under almost  
any bench

Zip Micro is 37% narrower, perfect for small kitchens for up to 10 people, delivering perfectly **boiling** and **chilled** water at your fingertips.



**Designed with space in mind**  
Our smallest underbench system footprint is 37%\* narrower.



**Optimised for up to 10 people**  
Keep up to 10 people hydrated with boiling only or boiling + chilled filtered water options.



**Easy to use**  
The Zip Micro tap design comes with an integrated safety lock and uses an intuitive twist activation with auto and manual fill options. The underbench system comes with pre-configured settings and modes.



**Micro-filtration for pure tasting water**  
Zip Micro uses the latest filtration technology for pure-tasting water. Zip filters are certified to reduce bacteria, sediment, odours to NSF 42 (aesthetic effects) and NSF 53 (health effects).



**2020 Gold Accolade Winner**  
in the Product Design Domestic Appliances category in recognition for outstanding design and innovation.

# The Zip HydroTap UltraCare system is proven to deliver 99.9% reduction in Legionella\*

Zip HydroTap UltraCare uses a combination of localised treatments and barriers that are proven as the most effective method of reducing waterborne organisms and pathogens including Legionella\*\*.

The barriers provided in the UltraCare system are:

- MicroPurity™ 0.2-micron carbon-free filtration
- SteriTouch® antimicrobial enhanced surfaces
- MicroPurity™ UV-C LED disinfection
- Lifecycle maintenance plan
- Zip HydroCare Gold+

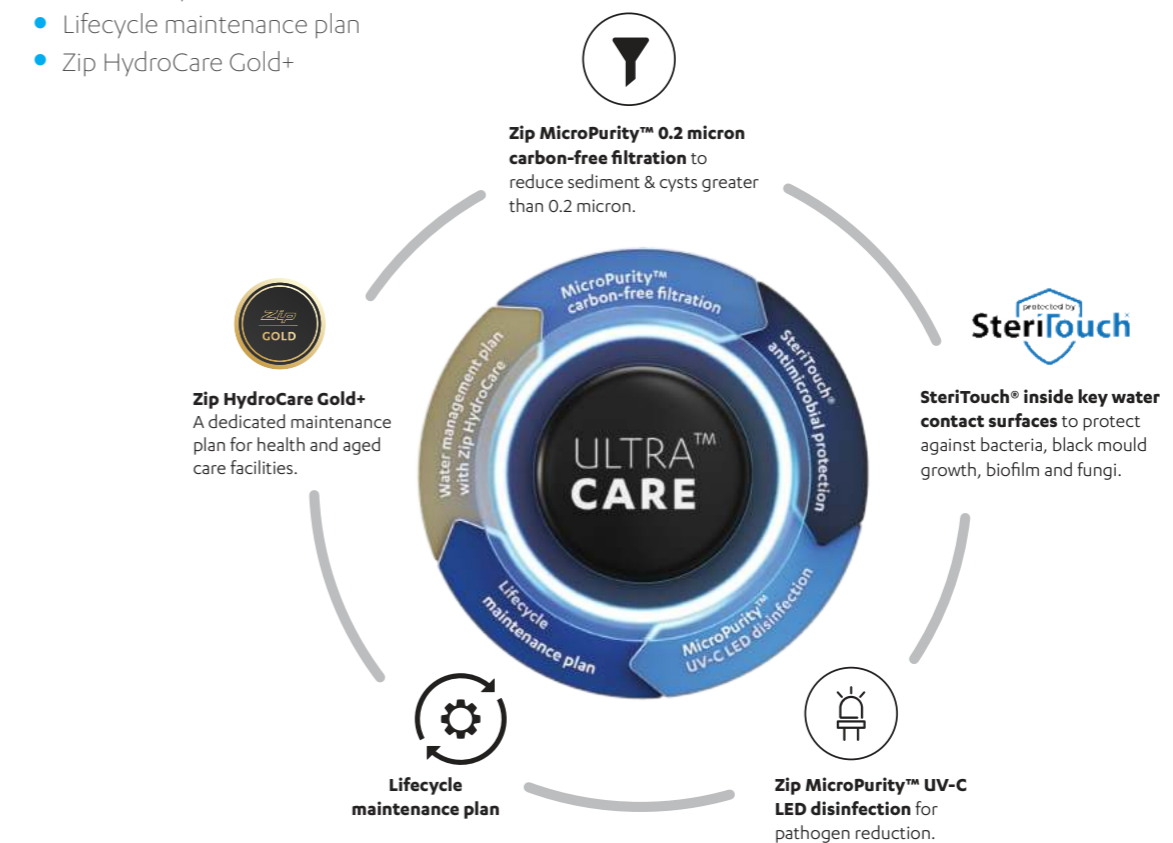

Zip HydroTap UltraCare is available in 3 tap designs



HydroTap Touch-Free Wave



HydroTap Classic Plus



HydroTap Classic with accessible levers

\*ALS Pty Ltd Testing of the Zip HydroTap UltraCare system efficacy tests.

\*\*enHealth 2015 Guidelines for Legionella control in the operation and maintenance of water distribution systems in health and aged care facilities, Australian Government, Canberra.



# HydroTap, powered by new G5 technology

Leading the way in performance and functionality, Zip's fifth generation G5 technology continues to deliver the convenience you would expect from a HydroTap.

Perfected over 70 years of development and innovation, HydroTap G5 transforms tap water into a form you will love, in an instant.

The G5 command centre is WaterMark approved, which means it is fit for purpose and appropriately authorised for use in plumbing and drainage installations.



## HydroTap product warranty

Zip HydroTap G5 is backed by a 36 month comprehensive parts and labour warranty, plus a further 24 months on internal tanks.

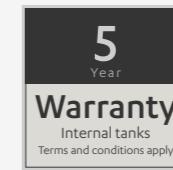

### PowerPulse technology



Our innovative Zip PowerPulse technology maintains stored boiling water to within 0.2°C of your set temperature, meaning no energy or time is wasted waiting for water to boil.

### Unique safety features



Zip boiling water is delivered smoothly and the tap has a safety lock to facilitate safe boiling water delivery.

### Air-cooled system



Our unique air-cooled refrigeration system is 100% water efficient.

### Auto-diagnostics



An advanced auto-diagnostics system continuously monitors your HydroTap's performance.

### MicroPurity™ filtration



Inbuilt 0.2 micron NSF-certified filter incorporating innovative silver ion antimicrobial technology means healthier, pure-tasting water for your workplace.

### Smart Customisation



New optimised menu in the G5 HydroTap command centre allows you to select energy modes and usage settings for easier customisation.

### SteriTouch® antimicrobial protection



SteriTouch® is impregnated inside materials in contact with key water paths in HydroTap for added protection against surface bacteria.

### Touch-Free Technology



Zip HydroTap Touch-Free Wave uses smart infrared sensors to activate the tap to dispense boiling, chilled and sparkling water, all without touching the tap.

### CO<sub>2</sub> level indicator



New feature in the command centre shows when CO<sub>2</sub> gas is running low.



# Pure-tasting filtered water with Zip MicroPurity filtration

At Zip Water, we put water quality at the heart of our offering, with perfectly filtered boiling, chilled and sparkling water instantly.

Our mission is to help our customers to enjoy pure-tasting water, on tap, all the time, and that is why only the best tasting water will do.

## Advanced filtration in every HydroTap system

Zip MicroPurity uses the latest filtration technology to filter and reduce impurities and potentially harmful contaminants larger than 0.2 microns in size – an impurity that will fit 250 times into a strand of hair.

## Easy to maintain

We recommend regular filter changes to ensure you continue to enjoy pure-tasting water. Our MicroPurity filters are easy to change with a hygienic cartridge and our qualified service technicians can also perform filter changes for your convenience.

## Trust Zip genuine filters

Every Zip HydroTap system comes fitted with a genuine MicroPurity filter, certified to reduce contaminants.

Crystal clear pure-tasting water



**MICROPURITY™  
FILTRATION**

SAFELY FILTERS DOWN TO 0.2 MICRON

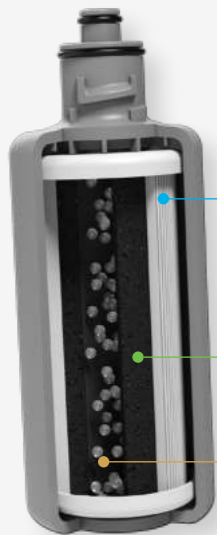

### Triple Action Technology

- 1. Removes particulates greater than 5 micron**  
Pleated membrane pre-filtration
- 2. Filter reduces particulates, lead, chlorine, taste, odour and cysts to 0.2 micron**  
0.2 micron Fibredyne carbon element including bacteriostatic effect
- 3. Reduces limescale build up**  
Limescale inhibitor

Zip MicroPurity filters are certified to reduce chlorine, taste, odour, bacteria, sediment and limescale in line with NSF 42 (aesthetic effects) and WaterMark requirements.

Zip MicroPurity filtration is also certified to deliver a reduction of 99.9% of cysts including cryptosporidium and giardia, and lead reduction of 98.9% to NSF 53 (health effects).



## Water for a healthier workplace

Workplace wellness and wellbeing is vital to your team remaining engaged and productive. Water plays a significant role in the function of the brain, so ensuring your staff have access to fresh, healthy water is essential.

Zip Water research shows that 80% of Zip HydroTap owners drink more water than before\*. Drinking more water offers a range of benefits, such as better concentration and less fatigue. Plus, the increased activity from getting up and moving around increases circulation, encourages the elimination of waste and toxins, and reduces the damaging effects of long periods of inactivity.

Zip HydroTap meets all your workplace water solution needs, in one elegant, easy to use system.

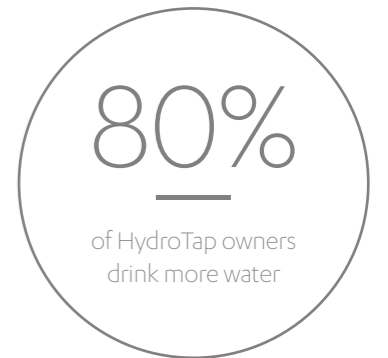

\*Research carried out to 340 existing Zip HydroTap customers

# The widest range of designs and finishes



Touch-Free Wave\*    Classic Plus    Elite Plus    Classic\*\*    Classic All-In-One\*\*    Micro\*\*\*    **NEW** Arc Plus    **NEW** Cube Plus    Celsius All-In-One    Celsius Arc    Celsius Cube

## Popular finish options

Whether you opt for a classic Chrome or stylish Matte Black, our range of timeless popular finishes has been designed to sit seamlessly in a wide range of kitchen designs, from contemporary to traditional.

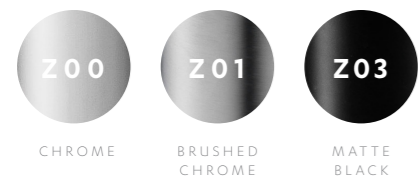

## Platinum finish options

Taking the HydroTap from a kitchen appliance you can't live without to a striking design accessory, our platinum finish options include stylish metallic finishes, each stunning in its own right.



\*Available in Chrome and Matte Black two tone finish.  
 \*\*Available only in popular finish options  
 \*\*\*Available only in Chrome and Matte Black finish options

# Environmentally responsible

## Independently verified Environmental Product Declaration

In another first for the world leaders in instant drinking water systems, Zip has released an internationally recognised and independently verified Environmental Product Declaration (EPD) for its HydroTap products. Developed with leading sustainability consulting company, **thinkstep\***, it is the first EPD for an electrical product in Australasia, clearly demonstrating Zip's innovative and forward-thinking approach.

The HydroTap EPD details the environmental impact of the product throughout its life cycle, from the production and processing of raw materials, to manufacturing, distribution, installation, ongoing usage, maintenance and filter changing, right down to the end of the product's life.

Australians buy **over 580 MILLION** litres of bottled water a year.

Much of which ends up in **LANDFILL** and on our **BEACHES#**

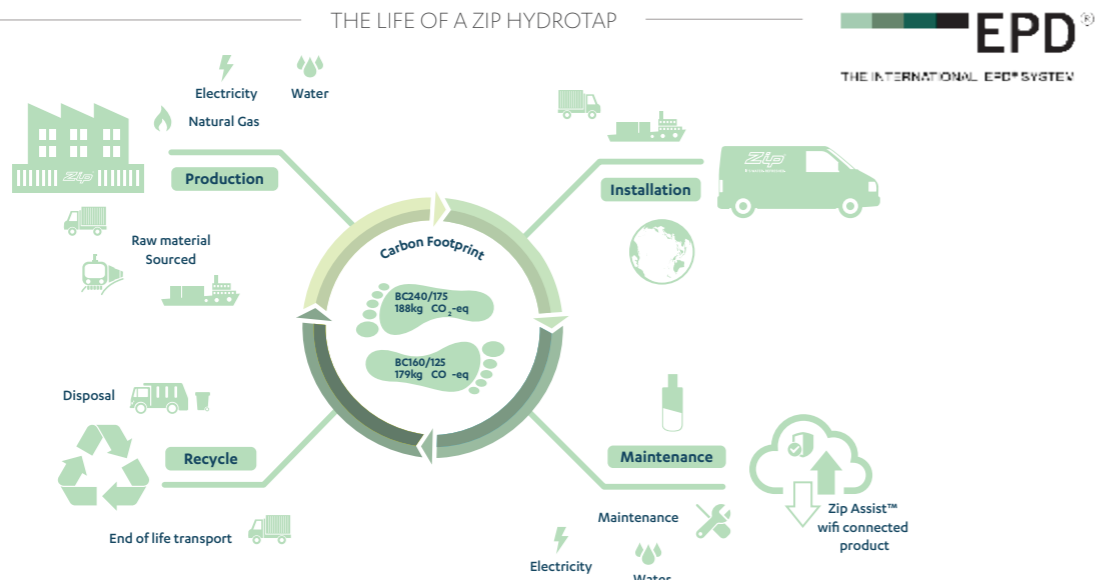

### Responsible manufacturing

Organisational dedication to sustainability



### Innovative air-cooled technology

Making HydroTap 100% water efficient



### Low impact design

Complies with RoHS EU Directive 2002/95/EC



### Smart energy saving modes

Time switch adheres to the Building Code of Australia



### World class environmental credentials

Providing transparent product life cycle impact



### Eliminates the need for bottled water

Reducing your environmental impact



## Sustainable manufacturing

Zip Water products are Australian-made in Condell Park, New South Wales and exported to the rest of the world. Our manufacturing adheres to the highest standards of environmental responsibility and ensures the Zip HydroTap is manufactured sustainably.

**ISO14001** is about much more than just designing an energy efficient product. It is complete organisational dedication to sustainable environmental management and ensures genuine commitment to a sound environment management system.

Zip Water is the only Australian manufacturer in our category to be accredited with all of the following internationally recognised standards:

- ISO14001** – Environmental Systems compliance and independently audited standards
- ISO9001** – Quality Management System
- AS/NZS 4801** – Workplace Health and Safety System



\*oceanrangers.org/plastic-crusades/plastic-statistics/  
 \*Thinkstep certified life cycle assessment and EPD verifiers - www.thinkstep-anz.com

## Safe and accessible

All Zip products are designed to be completely safe and easy to use, with unique boiling water safety locks and cool touch technology. You can be confident that the end user can operate our systems safely, without needing to worry about spluttering steam.

For users with limited mobility or impaired vision, Zip HydroTap Classic is also available with accessible levers. The oversized levers incorporates braille into the colour coded red and blue options to indicate boiling or chilled drinking water.

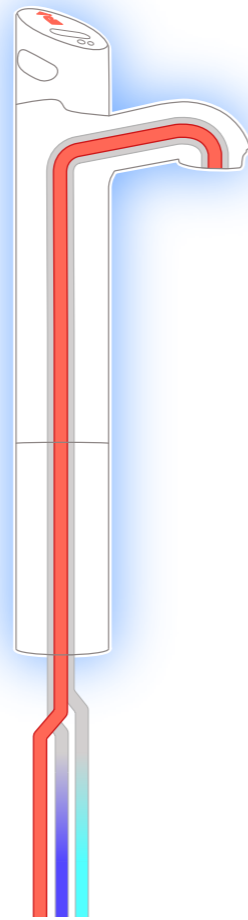

**Featured product**  
HydroTap Classic with oversized levers and braille covers.



## The Zip service difference



Our highly skilled network of mobile technicians and friendly customer service team are here to help keep your Zip products in top working order. Our expert technicians install HydroTaps across residential and commercial kitchens, and we can maintain any drinking water systems.

### Full national coverage

With more than 100 Zip certified technicians and 270 authorised service providers across the country, fully trained and qualified support is never far away.

### Fast and efficient

Every Zip service technician carries a range of spare parts, genuine filters and CO<sub>2</sub> canisters to repair on first time attendance, which means you can get back to enjoying your fresh, filtered water in no time.

### Professional repairs and maintenance

Zip certified technicians are highly skilled, specialised and factory trained with years of experience to ensure you receive efficient, reliable and prompt service and repairs.

### HydroTap certified installation

Zip Water offers an installation service, with a national fleet of certified installers who can install your HydroTap in any kitchen.

Our certified installers will make sure your HydroTap is up and running in no time and includes stone cutting for tap and font installation.

### Be informed with updates

Get up-to-date SMS notifications when your Zip service technician is on their way to your service call to save you time in your day.

### High customer satisfaction

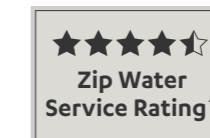

We aim to provide our customers with professional care at a high standard and take pride on our level of service.

### HydroTap product warranty

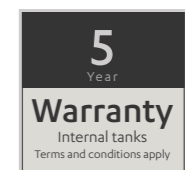
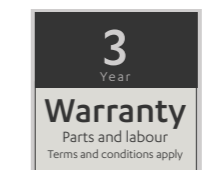

### Preventative maintenance plans

For ultimate peace of mind, Zip Water offers professional care of your system with a comprehensive range of HydroCare packages covering every maintenance requirement.

With everything you need to enjoy pure-tasting water, HydroCare ensures your HydroTap not only remains in perfect condition but operates at peak performance.



# A history of drinking water innovation for over 75 years

Zip Water is a world-leading designer and manufacturer of instant boiling, chilled and sparkling filtered water solutions. Zip Water invests in Australian-based innovation design and world-class manufacturing to continually enhance water quality, functionality, energy efficiency and aesthetic appeal. Recognised as a global innovator, Zip Water's products are sought after and installed in over 75 countries worldwide, providing homes and workplaces with the purest-tasting, safest and cleanest water possible.



**1947**

Zip founded in Australia as a manufacturer of sink & bath heaters



**1975**

Zip introduces the world's first small On-Wall instant boiling water system



**1980**

Miniboil On-Wall instant boiling water launches for residential kitchens



**1984**

Zip Miniboil wins Australian design award



**1988**

Zip specified into Parliament House, Canberra



**1991**

Zip opens in the UK and soon wins a place in 10 Downing Street



**1993**

Zip upgrades technology for Hydroboil On-Wall instant boiling water



**1996**

Zip launches HydroTap underbench instant boiling water



**2004**

Zip HydroTap redesign wins Australian Design Mark



**2007**

Zip launches advanced electronically controlled Hydroboil



**2012**

Zip launches world's first boiling, chilled and sparkling water on tap



**2014**

Zip launches G4, the fourth generation of HydroTap



**2015**

Zip launches Design Range with three new styles



**2016**

Zip introduces eight new platinum finishes



**2017**

Zip launches Celsius All-in-One Arc



**2018**

Zip launches HydroChill high capacity sparkling systems



**2019**

Zip launches Micro, our smallest drinking water system



**2020**

Zip launches HydroTap Touch-Free Wave, a 100% contactless solution

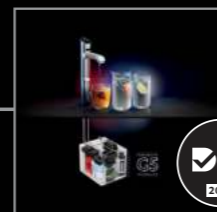

**2021**

Zip launches HydroTap G5, the fifth generation of HydroTap and UltraCare



**2022**

Zip launches Arc Plus and Cube Plus



ZIP HYDROTAP COMMERCIAL

# Classic range

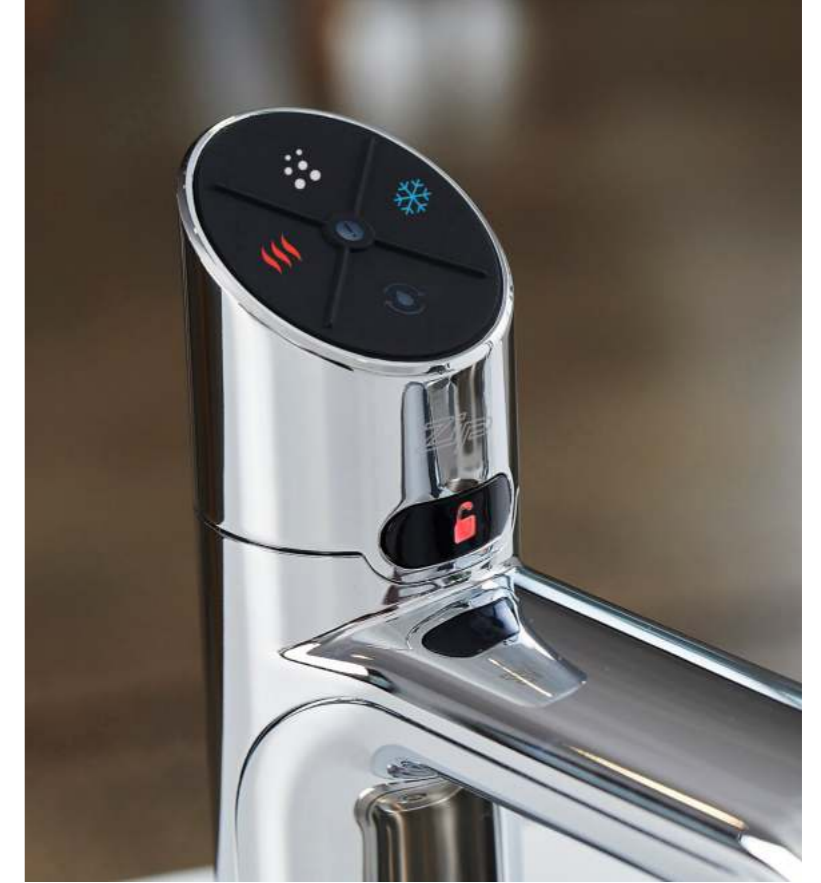

**Featured product**

Opposite Page - HydroTap Classic All-In-One in Chrome finish

Top Right - HydroTap Classic Plus in Chrome finish

Bottom Right - HydroTap Touch-Free Wave in Chrome finish

# Touch-Free Wave

**Featured product**  
HydroTap Touch-Free Wave  
in Chrome finish

For workplaces looking to reduce shared touchpoints. Zip HydroTap Touch-Free Wave provides a 100% touch-free solution to instantly dispense pure-tasting drinking water with a simple wave of a hand.



Available water options & finishes:

FILTERED: <b>BOILING</b> CHILLED SPARKLING	FILTERED: <b>BOILING</b> CHILLED	FILTERED: <b>CHILLED</b> SPARKLING	FILTERED: <b>CHILLED</b>	FILTERED: <b>BOILING</b> AMBIENT	FILTERED: <b>BOILING</b>

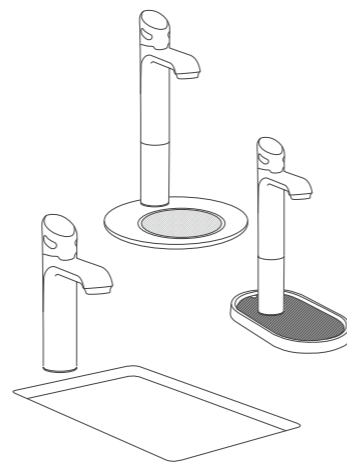

HydroTap Touch-Free Wave can be installed over sink or optional front.



# Touch-Free Wave with Mixer

**Featured product**  
HydroTap Touch-Free Wave with Arc Mixer  
installed over sink in Matte Black finish

Designed for situations with only a cold water supply. Perfect for workplace kitchens that require a mixer tap and a Zip HydroTap in the same area as well as hot water to the sink.



Available water options & finishes:

FILTERED: <b>BOILING</b> CHILLED SPARKLING	UNFILTERED: <b>HOT &amp; COLD</b>	FILTERED: <b>BOILING</b> CHILLED	UNFILTERED: <b>HOT &amp; COLD</b>
5-In-1		4-In-1	

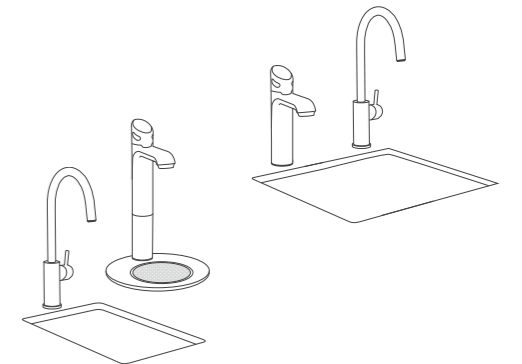

HydroTap Touch-Free Wave can be installed over sink or optional front

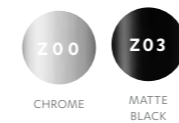



# Classic Plus

**Featured product**  
HydroTap Classic Plus installed over sink  
in Chrome finish

Offering boiling, chilled and sparkling water in a modern design with intuitive controls.



Available water options & finishes:

FILTERED: <b>BOILING</b> CHILLED SPARKLING	FILTERED: <b>BOILING</b> CHILLED	FILTERED: <b>CHILLED</b> SPARKLING	FILTERED: <b>CHILLED</b>	FILTERED: <b>BOILING</b> AMBIENT	FILTERED: <b>BOILING</b>

POPULAR

- Z00  
CHROME
- Z01  
BRUSHED  
CHROME
- Z03  
MATTE  
BLACK

PLATINUM

- Z05  
BRUSHED  
ROSE GOLD
- Z07  
BRUSHED  
GOLD
- Z09  
GUNMETAL
- Z11  
BRUSHED  
NICKEL

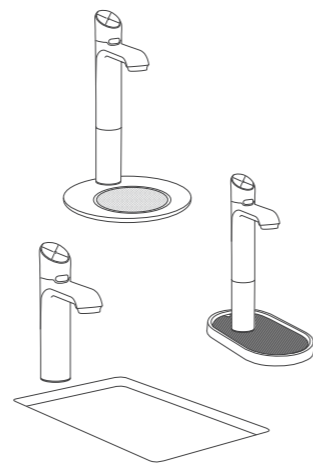

HydroTap Classic Plus can be installed over sink or optional font.

# Classic Plus with Mixer

**Featured product**  
HydroTap Classic Plus with Arc Mixer  
installed over sink in Matte Black finish

Designed for situations with only a cold water supply. Perfect for workplace kitchens that require a mixer tap and a Zip HydroTap in the same area as well as hot water to the sink.



Available water options & finishes:

FILTERED: <b>BOILING</b> CHILLED SPARKLING	UNFILTERED: <b>HOT &amp; COLD</b>	FILTERED: <b>BOILING</b> CHILLED	UNFILTERED: <b>HOT &amp; COLD</b>	FILTERED: <b>BOILING</b>	FILTERED: <b>HOT &amp; COLD</b>
5-In-1		4-In-1		3-In-1	

POPULAR

- Z00  
CHROME
- Z01  
BRUSHED  
CHROME
- Z03  
MATTE  
BLACK

PLATINUM

- Z05  
BRUSHED  
ROSE GOLD
- Z07  
BRUSHED  
GOLD
- Z09  
GUNMETAL
- Z11  
BRUSHED  
NICKEL

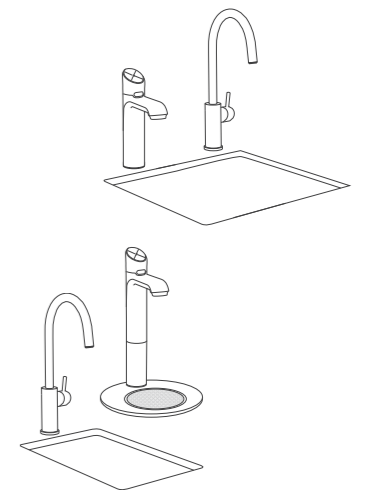

HydroTap Classic Plus can be installed over sink or optional font

# Classic

**Featured product**  
HydroTap Classic installed with optional font  
in Chrome finish

Offering the choice of instant filtered boiling, chilled or sparkling water, or all three in any combination, the iconic design of the Classic HydroTap remains a much-loved and popular choice suited to any workplace.



Available water options & finishes:

FILTERED: <b>BOILING</b> CHILLED SPARKLING	FILTERED: <b>BOILING</b> CHILLED	FILTERED: <b>CHILLED</b> SPARKLING	FILTERED: <b>CHILLED</b>	FILTERED: <b>BOILING</b> AMBIENT	FILTERED: <b>BOILING</b>

POPULAR

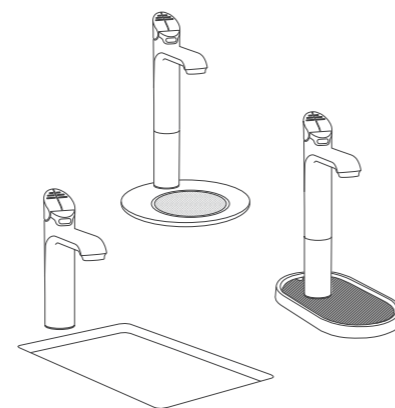
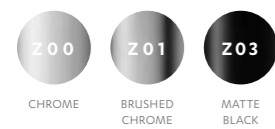

HydroTap Classic can be installed over sink or optional font

# Classic with Mixer

**Featured product**  
HydroTap Classic with Arc Mixer installed over sink  
in Chrome finish

Designed for situations with only a cold water supply. Perfect for workplace kitchens that require a mixer tap and a Zip HydroTap in the same area as well as hot water to the sink.



The more stars the more water efficient

**WATER RATING**

www.waterrating.gov.au

**3.0**

litres per minute

In accordance with AS/NZS 6400

Licence No. 0086

Zip Heaters (Aust) Pty Ltd

The more stars the more water efficient

**WATER RATING**

www.waterrating.gov.au

**5.5**

litres per minute

In accordance with AS/NZS 6400

Licence No. 0086

Zip Heaters (Aust) Pty Ltd

Classic Mixer
Arc & Cube Mixer

Available water options & finishes:

FILTERED: <b>BOILING</b> CHILLED SPARKLING	UNFILTERED: <b>HOT &amp; COLD</b>	FILTERED: <b>BOILING</b> CHILLED	UNFILTERED: <b>HOT &amp; COLD</b>	FILTERED: <b>BOILING</b>	FILTERED: <b>HOT &amp; COLD</b>
5-In-1		4-In-1		3-In-1	

POPULAR

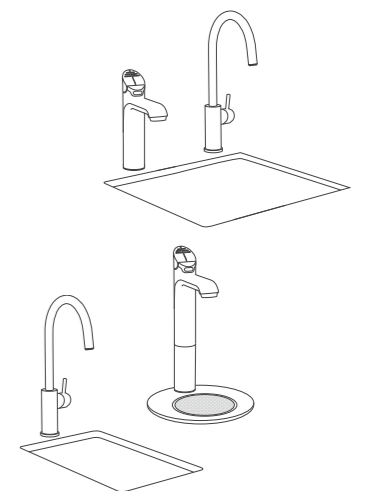
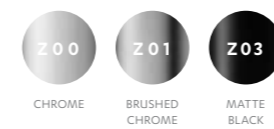

HydroTap Classic can be installed over sink or optional font

# Classic All-In-One

**Featured product**  
HydroTap Classic All-In-One installed over sink  
in Chrome finish

The Classic HydroTap All-In-One offers filtered boiling, chilled and sparkling water, plus unfiltered hot and cold water from a single tap.



Available water options & finishes:

FILTERED: <b>BOILING</b> CHILLED SPARKLING	UNFILTERED: HOT & COLD	FILTERED: <b>BOILING</b> CHILLED	UNFILTERED: HOT & COLD

POPULAR

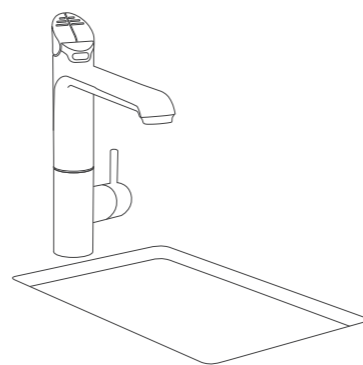
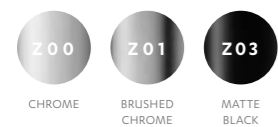

HydroTap Classic All-In-One can be installed over sink only

# Classic Industrial

**Featured product**  
HydroTap Classic Industrial installed on  
optional font in Chrome finish

For Industrial and Correctional Facilities. Designed with strength and security, the Classic Industrial is proven under the toughest industrial and institutional conditions.



Available water options & finishes:

FILTERED: <b>BOILING</b> CHILLED	FILTERED: <b>BOILING</b>

POPULAR



High strength vandal resistant tapered base

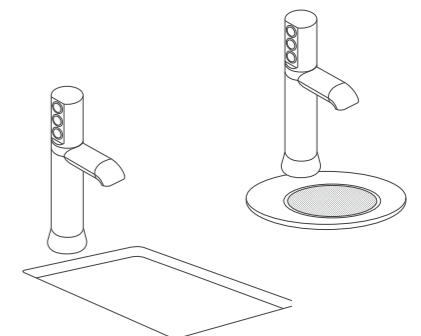

HydroTap Classic Industrial can be installed over sink or optional font

# Classic for accessibility

**Featured product**  
HydroTap Classic with accessibility levers installed with optional font in Chrome finish

Classic for accessibility is designed for users with limited mobility or impaired vision.

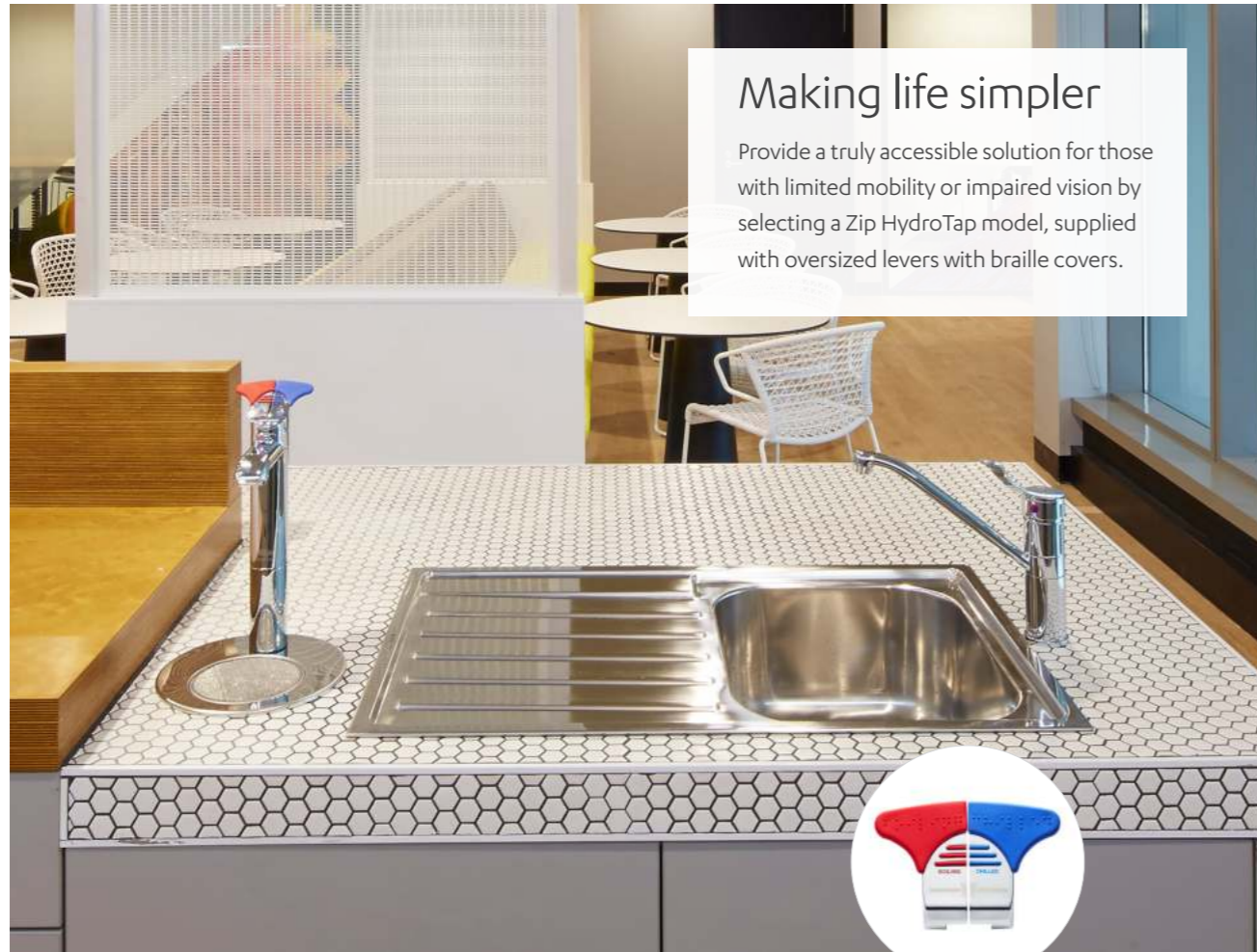

## Making life simpler

Provide a truly accessible solution for those with limited mobility or impaired vision by selecting a Zip HydroTap model, supplied with oversized levers with braille covers.



Oversized colour coded braille tap levers

Available water options & finishes:

FILTERED: <b>BOILING</b> CHILLED SPARKLING	FILTERED: <b>BOILING</b> CHILLED	FILTERED: <b>CHILLED</b> SPARKLING	FILTERED: <b>CHILLED</b>	FILTERED: <b>BOILING</b> AMBIENT	FILTERED: <b>BOILING</b>

POPULAR

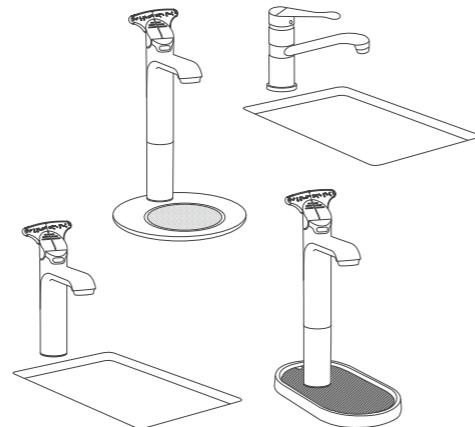
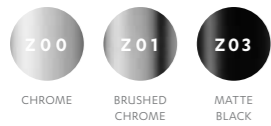

HydroTap Classic with accessibility levers can be installed over sink or optional font

ZIP HYDROTAP COMMERCIAL

# Design range

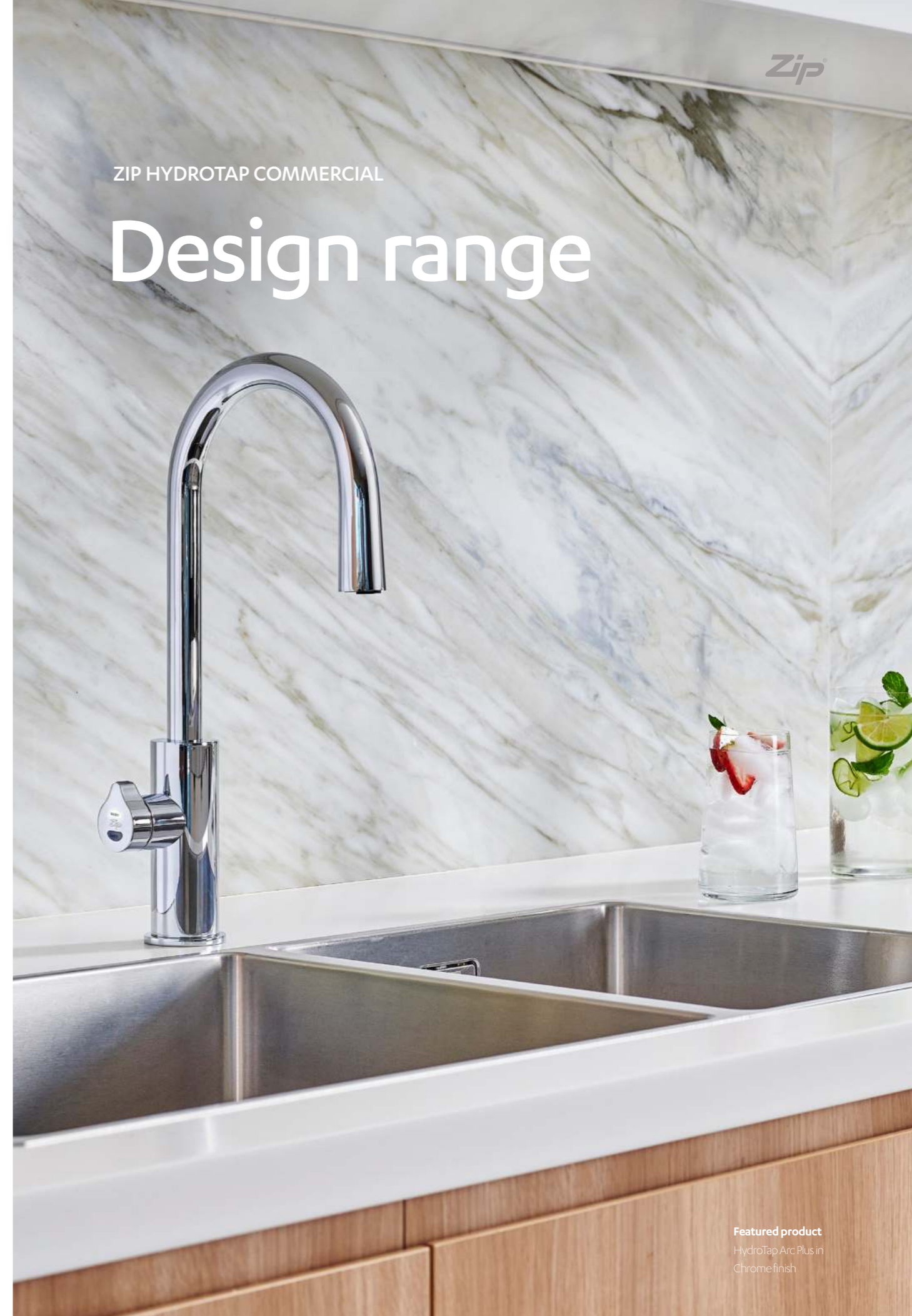

**Featured product**  
HydroTap Arc Plus in Chrome finish

# Arc Plus

**Featured product**  
HydroTap Arc Plus installed over sink  
in Chrome finish

With an elegant curved shape, Zip HydroTap Arc Plus will complement any contemporary office or corporate space – available in boiling, chilled or sparkling water, or all three in any combination.



Available water options & finishes:

FILTERED: <b>BOILING</b> CHILLED SPARKLING	FILTERED: <b>BOILING</b> CHILLED	FILTERED: <b>CHILLED</b> SPARKLING	FILTERED: <b>CHILLED</b>	FILTERED: <b>BOILING</b> AMBIENT	FILTERED: <b>BOILING</b>

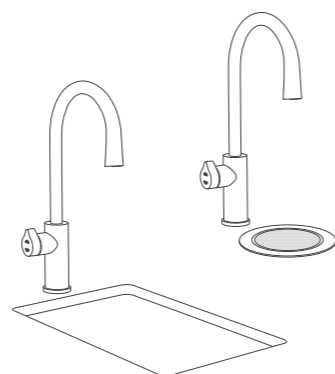

HydroTap Arc Plus can be installed over sink or optional font

- POPULAR**
- Z00 CHROME
  - Z01 BRUSHED CHROME
  - Z03 MATTE BLACK
- PLATINUM**
- Z05 BRUSHED ROSE GOLD
  - Z07 BRUSHED GOLD
  - Z09 GUNMETAL
  - Z11 BRUSHED NICKEL

# Arc Plus with Mixer

**Featured product**  
HydroTap Arc Plus installed with Arc Mixer  
in Chrome finish

Designed for situations with only a cold water supply. Perfect for workplace kitchens that require a mixer tap and a Zip HydroTap in the same area.



Available water options & finishes:

FILTERED: <b>BOILING</b> CHILLED SPARKLING	UNFILTERED: <b>HOT &amp; COLD</b>	FILTERED: <b>BOILING</b> CHILLED	UNFILTERED: <b>HOT &amp; COLD</b>	FILTERED: <b>BOILING</b>	FILTERED: <b>HOT &amp; COLD</b>
5-In-1		4-In-1		3-In-1	

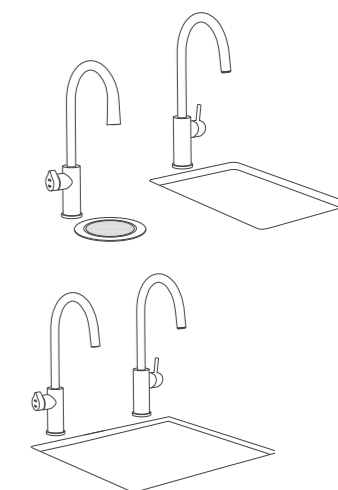

HydroTap Arc Plus can be installed over sink or optional font

- POPULAR**
- Z00 CHROME
  - Z01 BRUSHED CHROME
  - Z03 MATTE BLACK
- PLATINUM**
- Z05 BRUSHED ROSE GOLD
  - Z07 BRUSHED GOLD
  - Z09 GUNMETAL
  - Z11 BRUSHED NICKEL

# Cube Plus

**Featured product**  
HydroTap Cube Plus installed over sink  
in Chrome finish

The stylish Zip HydroTap Cube Plus is both a source of inspiration and a source of wellness – available in boiling, chilled or sparkling water, or all three in any combination.



Available water options & finishes:

FILTERED: <b>BOILING</b> CHILLED SPARKLING	FILTERED: <b>BOILING</b> CHILLED	FILTERED: <b>CHILLED</b> SPARKLING	FILTERED: <b>CHILLED</b>	FILTERED: <b>BOILING</b> AMBIENT	FILTERED: <b>BOILING</b>

POPULAR

- Z00  
CHROME
- Z01  
BRUSHED  
CHROME
- Z03  
MATTE  
BLACK

PLATINUM

- Z05  
BRUSHED  
ROSE GOLD
- Z07  
BRUSHED  
GOLD
- Z09  
GUNMETAL
- Z11  
BRUSHED  
NICKEL

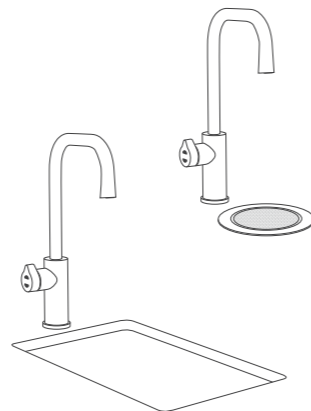

HydroTap Cube Plus can be installed over sink or optional front

# Cube Plus with Mixer

**Featured product**  
HydroTap Cube Plus installed with Cube Mixer  
in Matte Black finish

Designed for situations with only a cold water supply. Perfect for workplace kitchens that require a mixer tap and a Zip HydroTap in the same area.



Available water options & finishes:

FILTERED: <b>BOILING</b> CHILLED SPARKLING	UNFILTERED: <b>HOT &amp; COLD</b>	FILTERED: <b>BOILING</b> CHILLED	UNFILTERED: <b>HOT &amp; COLD</b>	FILTERED: <b>BOILING</b>	FILTERED: <b>HOT &amp; COLD</b>
5-In-1		4-In-1		3-In-1	

POPULAR

- Z00  
CHROME
- Z01  
BRUSHED  
CHROME
- Z03  
MATTE  
BLACK

PLATINUM

- Z05  
BRUSHED  
ROSE GOLD
- Z07  
BRUSHED  
GOLD
- Z09  
GUNMETAL
- Z11  
BRUSHED  
NICKEL

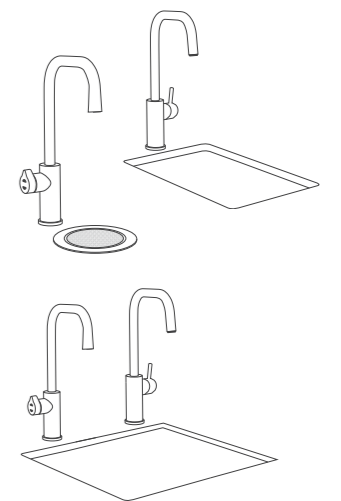

HydroTap Cube Plus can be installed over sink or optional front

# Elite Plus

**Featured product**  
HydroTap Elite Plus installed over sink  
in Matte Black finish

Form meets function with the sophisticated and innovative Zip HydroTap Elite Plus – available in boiling, chilled or sparkling water, or all three in any combination.



Available water options & finishes:

<b>FILTERED:</b> <b>BOILING</b> <b>CHILLED</b> <b>SPARKLING</b>	<b>FILTERED:</b> <b>BOILING</b> <b>CHILLED</b>	<b>FILTERED:</b> <b>CHILLED</b> <b>SPARKLING</b>	<b>FILTERED:</b> <b>CHILLED</b>	<b>FILTERED:</b> <b>BOILING</b> <b>AMBIENT</b>	<b>FILTERED:</b> <b>BOILING</b>

POPULAR

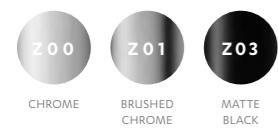

PLATINUM

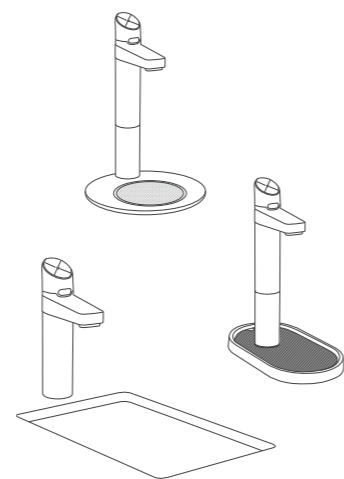

HydroTap Elite Plus can be installed over sink or optional front

# Elite Plus with Mixer

**Featured product**  
HydroTap Elite Plus with Arc Mixer installed over  
sink in Brushed Chrome finish

Designed for situations with only a cold water supply. Perfect for workplace kitchens that require a mixer tap and a Zip HydroTap in the same area.



**WATER RATING**  
www.waterrating.gov.au

**3.0** litres per minute

In accordance with AS/NZS 6400  
Licence No. 0086  
Zip Heaters (Aust) Pty Ltd

Classic Mixer

**WATER RATING**  
www.waterrating.gov.au

**5.5** litres per minute

In accordance with AS/NZS 6400  
Licence No. 0086  
Zip Heaters (Aust) Pty Ltd

Arc & Cube Mixer

Available water options & finishes:

<b>FILTERED:</b> <b>BOILING</b> <b>CHILLED</b> <b>SPARKLING</b>	<b>UNFILTERED:</b> <b>HOT &amp; COLD</b>	<b>FILTERED:</b> <b>BOILING</b> <b>CHILLED</b>	<b>UNFILTERED:</b> <b>HOT &amp; COLD</b>	<b>FILTERED:</b> <b>BOILING</b>	<b>FILTERED:</b> <b>HOT &amp; COLD</b>
5-In-1		4-In-1		3-In-1	

POPULAR

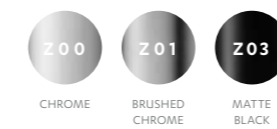

PLATINUM

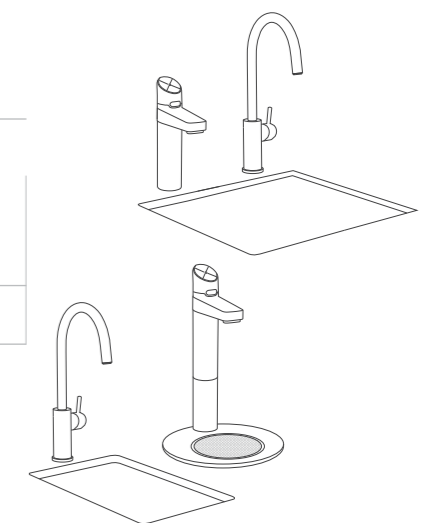

HydroTap Elite Plus can be installed over sink or optional front

ZIP HYDROTAP COMMERCIAL

# Celsius range

GOOD DESIGN Award



**Featured product**  
HydroTap Celsius All-In-One  
in Brushed Gold finish

# Celsius All-In-One

**Featured product**  
HydroTap Celsius All-In-One installed over sink  
in Chrome finish

The ultimate in functionality, the All-In-One Celsius Arc is fitted over your sink and offers all five water types – filtered boiling, chilled and sparkling drinking water, plus unfiltered hot and cold water – from a single tap.



\*This product needs a hot and cold water supply

Available water options & finishes:

FILTERED: <b>BOILING</b> CHILLED SPARKLING	UNFILTERED: HOT & COLD	FILTERED: <b>BOILING</b> CHILLED	UNFILTERED: HOT & COLD

POPULAR

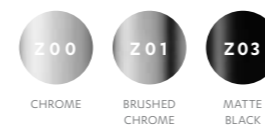

PLATINUM

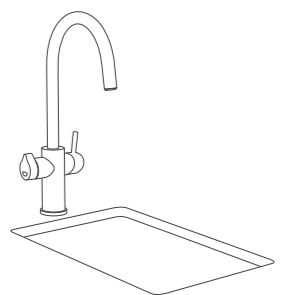

HydroTap Celsius All-In-One can be installed over sink only



# Celsius Arc

**Featured product**  
HydroTap Celsius Arc installed over sink  
in Brushed Rose Gold finish

The Celsius Arc delivers your choice of filtered boiling, or chilled, or chilled and sparkling water, plus unfiltered hot and cold water – from a single tap.



\*This product needs a hot and cold water supply

Available water options & finishes:

<b>FILTERED:</b> <b>CHILLED</b> <b>SPARKLING</b>	<b>UNFILTERED:</b> <b>HOT &amp; COLD</b>	<b>FILTERED:</b> <b>CHILLED</b>	<b>UNFILTERED:</b> <b>HOT &amp; COLD</b>	<b>FILTERED:</b> <b>BOILING</b>	<b>FILTERED:</b> <b>HOT &amp; COLD</b>

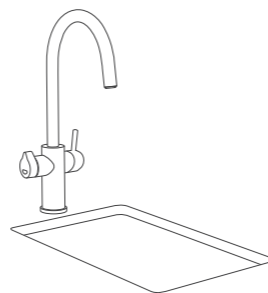

HydroTap Celsius Arc can be installed over sink only

POPULAR

- Z00**  
CHROME
- Z01**  
BRUSHED CHROME
- Z03**  
MATTE BLACK

PLATINUM

- Z05**  
BRUSHED ROSE GOLD
- Z07**  
BRUSHED GOLD
- Z09**  
GUNMETAL
- Z11**  
BRUSHED NICKEL

# Celsius Cube

**Featured product**  
HydroTap Celsius Cube installed over sink  
in Brushed Chrome finish

The Celsius Cube delivers your choice of filtered boiling, or chilled, or chilled and sparkling water, plus unfiltered hot and cold water – from a single tap.



\*This product needs a hot and cold water supply

Available water options & finishes:

<b>FILTERED:</b> <b>CHILLED</b> <b>SPARKLING</b>	<b>UNFILTERED:</b> <b>HOT &amp; COLD</b>	<b>FILTERED:</b> <b>CHILLED</b>	<b>UNFILTERED:</b> <b>HOT &amp; COLD</b>	<b>FILTERED:</b> <b>BOILING</b>	<b>FILTERED:</b> <b>HOT &amp; COLD</b>

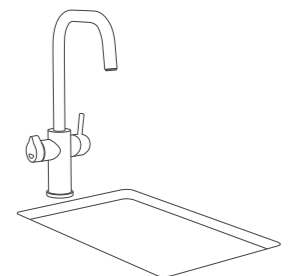

HydroTap Celsius Cube can be installed over sink only

POPULAR

- Z00**  
CHROME
- Z01**  
BRUSHED CHROME
- Z03**  
MATTE BLACK

PLATINUM

- Z05**  
BRUSHED ROSE GOLD
- Z07**  
BRUSHED GOLD
- Z09**  
GUNMETAL
- Z11**  
BRUSHED NICKEL

# Micro

**Featured product**  
HydroTap Micro installed over sink  
in Chrome finish

Zip Micro is our smallest system, designed to fit under almost any bench, but still delivers perfectly boiling and chilled water at your fingertips. Zip Micro is perfect for small workplaces with up to 10 people.



# Commercial HydroTap

CLASSIC PLUS



ORDER CODE	NO. PEOPLE	MODEL	WATER OPTIONS	CUPS	GLASSES	SIZE*
				PER HOUR	PER HOUR	H x W x D (mm)
H55760Z00AU	20	BCS	[[[ [snowflake] [bubbles] ]]	100	75	333 x 339 x 460
H55762Z00AU	60			160	175	333 x 395 x 464
H55763Z00AU	100			240*	175	333 x 395 x 464
H55702Z00AU	20	BC	[[[ [snowflake] ]]	100	75	333 x 280 x 455
H55703Z00AU	40			160	125	333 x 395 x 464
H55704Z00AU	60			160	175	333 x 395 x 464
H55705Z00AU	100	BA	[[[ [drop] ]]	240*	175	333 x 395 x 464
H55708Z00AU	60			160	-	333 x 280 x 313
H55709Z00AU	100			240*	-	333 x 280 x 313
H55706Z00AU	60	B	[[[ ]]	160	-	333 x 280 x 313
H55707Z00AU	100			240*	-	333 x 280 x 313
H55765Z00AU	100	CS	[snowflake] [bubbles]	-	150	333 x 280 x 480
H55710Z00AU	40	C	[snowflake]	-	125	333 x 280 x 476
H55711Z00AU	100			-	150	333 x 280 x 476

CLASSIC PLUS WITH CLASSIC MIXER

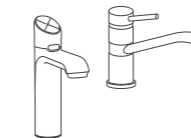

H55675Z00AU	60	BCSHA	[[[ [snowflake] [bubbles] [mixer] ]]	160	175	333 x 395 x 464
H55676Z00AU	100			240*	175	333 x 395 x 464
H55621Z00AU	20	BCHA	[[[ [snowflake] [mixer] ]]	100	75	333 x 280 x 455
H55622Z00AU	40			160	125	333 x 395 x 464
H55623Z00AU	60			160	175	333 x 395 x 464
H55624Z00AU	100			240*	175	333 x 395 x 464

Available water options & finishes:

FILTERED: BOILING CHILLED	FILTERED: BOILING
[[[ [snowflake] ]]	[[[ ]]

POPULAR

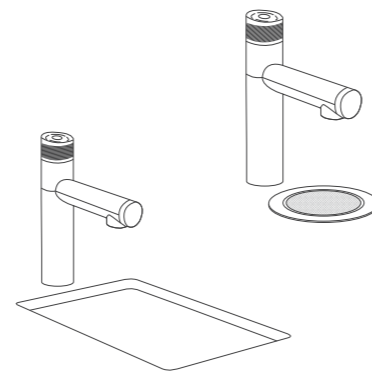

HydroTap Micro can be installed over sink or optional front

AVAILABLE IN:

POPULAR



PLATINUM

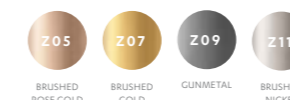

Order code listed above is for Chrome finish. To select a different finish, replace Z00 with the relevant colour code. For example, HydroTap G5 BCS20 Classic Plus in a Matte Black finish use code H51760Z03AU.

KEY TO ICONS

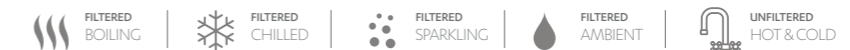

\*240 boiling cup per hour models include additional Booster and require 2 x 10 amp power GPOs. Refer to zipwater.com for full specification details.

Size relates to command centre - revert to installation diagram for clearance and ventilation.

Class size is 200ml and cup size 167ml.

'Ambient' describes the temperature of the water where there is no additional heating or chilling to the incoming cold water supply.

# Commercial HydroTap

CLASSIC PLUS WITH ARC MIXER

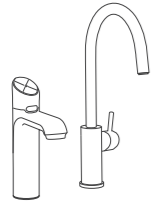

ORDER CODE	NO. PEOPLE	MODEL	WATER OPTIONS	CUPS PER HOUR	GLASSES PER HOUR	SIZE* H x W x D (mm)
H55875Z00AU	60	BCSHA		160	175	333 x 395 x 464
H55876Z00AU	100			240*	175	333 x 395 x 464
H55821Z00AU	20	BCHA		100	75	333 x 280 x 455
H55822Z00AU	40			160	125	333 x 395 x 464
H55823Z00AU	60			160	175	333 x 395 x 464
H55824Z00AU	100			240*	175	333 x 395 x 464
H55856Z00AU	60	BHA		160	-	333 x 280 x 313
H55857Z00AU	100			240*	-	333 x 280 x 313

CLASSIC PLUS WITH CUBE MIXER

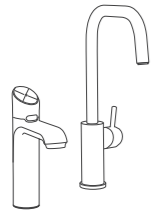

ORDER CODE	NO. PEOPLE	MODEL	WATER OPTIONS	CUPS PER HOUR	GLASSES PER HOUR	SIZE* H x W x D (mm)
H55975Z00AU	60	BCSHA		160	175	333 x 395 x 464
H55976Z00AU	100			240*	175	333 x 395 x 464
H55921Z00AU	20	BCHA		100	75	333 x 280 x 455
H55922Z00AU	40			160	125	333 x 395 x 464
H55923Z00AU	60			160	175	333 x 395 x 464
H55924Z00AU	100			240*	175	333 x 395 x 464
H55956Z00AU	60	BHA		160	-	333 x 280 x 313
H55957Z00AU	100			240*	-	333 x 280 x 313

AVAILABLE IN:



Order code listed above is for Chrome finish. To select a different finish, replace Z00 with the relevant colour code. For example, HydroTap GS BCSHA60 Classic Plus in a Matte Black finish use code H55875Z03AU.



\*240 boiling cup per hour models include additional Booster and require 2 x 10 amp power GPOs. Refer to zipwater.com for full specification details.

Size relates to command centre - revert to installation diagram for clearance and ventilation.

Glass size is 200ml and cup size 167ml.

'Ambient' describes the temperature of the water where there is no additional heating or chilling to the incoming cold water supply.

TOUCH-FREE WAVE



ORDER CODE	NO. PEOPLE	MODEL	WATER OPTIONS	CUPS PER HOUR	GLASSES PER HOUR	SIZE* H x W x D (mm)
H5W760Z00AU	20	BCS		100	75	333 x 339 x 460
H5W762Z00AU	60			160	175	333 x 395 x 464
H5W763Z00AU	100			240*	175	333 x 395 x 464
H5W702Z00AU	20	BC		100	75	333 x 280 x 455
H5W703Z00AU	40			160	125	333 x 395 x 464
H5W704Z00AU	60			160	175	333 x 395 x 464
H5W705Z00AU	100			240*	175	333 x 395 x 464
H5W708Z00AU	60	BA		160	-	333 x 280 x 313
H5W706Z00AU	60	B		160	-	333 x 280 x 313
H5W707Z00AU	100			240*	-	333 x 280 x 313
H5W765Z00AU	100	CS		-	150	333 x 280 x 480
H5W710Z00AU	40	C		-	125	333 x 280 x 476
H5W711Z00AU	100			-	150	333 x 280 x 476

TOUCH-FREE WAVE WITH CLASSIC MIXER

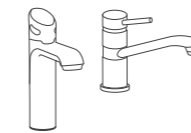

H5W675Z00AU	60	BCSHA		160	175	333 x 395 x 464
H5W676Z00AU	100			240*	175	333 x 395 x 464
H5W621Z00AU	20	BCHA		100	75	333 x 280 x 455
H5W622Z00AU	40			160	125	333 x 395 x 464
H5W623Z00AU	60			160	175	333 x 395 x 464
H5W624Z00AU	100			240*	175	333 x 395 x 464

AVAILABLE IN:

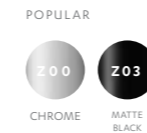

Order code listed above is for Chrome finish. To select a different finish, replace Z00 with the relevant colour code. For example, HydroTap GS BCS20 Touch-Free Wave in a Matte Black finish use code H5W760Z03AU.



\*240 boiling cup per hour models include additional Booster and require 2 x 10 amp power GPOs. Refer to zipwater.com for full specification details.

Size relates to command centre - revert to installation diagram for clearance and ventilation.

Glass size is 200ml and cup size 167ml.

'Ambient' describes the temperature of the water where there is no additional heating or chilling to the incoming cold water supply.

# Commercial HydroTap

## TOUCH-FREE WAVE WITH ACCESSIBLE MIXER

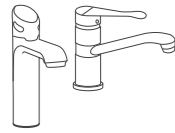

ORDER CODE	NO. PEOPLE	MODEL	WATER OPTIONS	CUPS PER HOUR	GLASSES PER HOUR	SIZE* H x W x D (mm)
H5WD21Z00AU	20	BCHA		100	75	333 x 280 x 455
H5WD22Z00AU	40			160	125	333 x 395 x 464
H5WD23Z00AU	60			160	175	333 x 395 x 464
H5WD24Z00AU	100			240*	175	333 x 395 x 464

## TOUCH-FREE WAVE WITH ARC MIXER

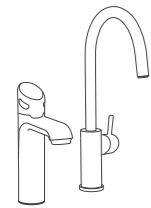

ORDER CODE	NO. PEOPLE	MODEL	WATER OPTIONS	CUPS PER HOUR	GLASSES PER HOUR	SIZE* H x W x D (mm)
H5W875Z00AU	60	BCSHA		160	175	333 x 395 x 464
H5W876Z00AU	100			240*	175	333 x 395 x 464
H5W821Z00AU	20	BCHA		100	75	333 x 280 x 455
H5W822Z00AU	40			160	125	333 x 395 x 464
H5W823Z00AU	60			160	175	333 x 395 x 464
H5W824Z00AU	100			240*	175	333 x 395 x 464

## TOUCH-FREE WAVE WITH CUBE MIXER

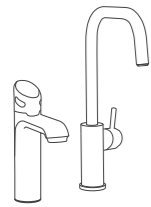

ORDER CODE	NO. PEOPLE	MODEL	WATER OPTIONS	CUPS PER HOUR	GLASSES PER HOUR	SIZE* H x W x D (mm)
H5W975Z00AU	60	BCSHA		160	175	333 x 395 x 464
H5W976Z00AU	100			240*	175	333 x 395 x 464
H5W921Z00AU	20	BCHA		100	75	333 x 280 x 455
H5W922Z00AU	40			160	125	333 x 395 x 464
H5W923Z00AU	60			160	175	333 x 395 x 464
H5W924Z00AU	100			240*	175	333 x 395 x 464

### AVAILABLE IN:

#### POPULAR

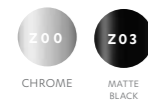

Order code listed above is for Chrome finish. To select a different finish, replace Z00 with the relevant colour code. For example, HydroTap GS BCHA20 Touch-Free Wave in a Matte Black finish use code H5WD21Z03AU.

#### KEY TO ICONS

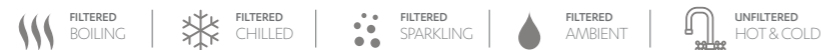

\*240 boiling cup per hour models include additional Booster and require 2 x 10 amp power GPOs. Refer to zipwater.com for full specification details.

Size relates to command centre - revert to installation diagram for clearance and ventilation.

Glass size is 200ml and cup size 167ml.

'Ambient' describes the temperature of the water where there is no additional heating or chilling to the incoming cold water supply.

## CLASSIC



ORDER CODE	NO. PEOPLE	MODEL	WATER OPTIONS	CUPS PER HOUR	GLASSES PER HOUR	SIZE* H x W x D (mm)
H51760Z00AU	20	BCS		100	75	333 x 339 x 460
H51762Z00AU	60			160	175	333 x 395 x 464
H51763Z00AU	100			240*	175	333 x 395 x 464
H51702Z00AU	20	BC		100	75	333 x 280 x 455
H51703Z00AU	40			160	125	333 x 395 x 464
H51704Z00AU	60			160	175	333 x 395 x 464
H51705Z00AU	100			240*	175	333 x 395 x 464
H51708Z00AU	60	BA		160	-	333 x 280 x 313
H51709Z00AU	100			240*	-	333 x 280 x 313
H51706Z00AU	60	B		160	-	333 x 280 x 313
H51707Z00AU	100			240*	-	333 x 280 x 313
H51765Z00AU	100	CS		-	150	333 x 280 x 480
H51710Z00AU	40	C		-	125	333 x 280 x 476
H51711Z00AU	100			-	150	333 x 280 x 476

## CLASSIC WITH CLASSIC MIXER

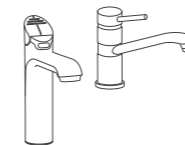

H51675Z00AU	60	BCSHA		160	175	333 x 395 x 464
H51676Z00AU	100			240*	175	333 x 395 x 464
H51621Z00AU	20	BCHA		100	75	333 x 280 x 455
H51622Z00AU	40			160	125	333 x 395 x 464
H51623Z00AU	60			160	175	333 x 395 x 464
H51624Z00AU	100			240*	175	333 x 395 x 464
H51656Z00AU	60	BHA		160	-	333 x 280 x 313
H51657Z00AU	100			240*	-	333 x 280 x 313

### AVAILABLE IN:

#### POPULAR

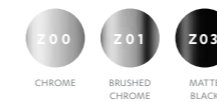

Order code listed above is for Chrome finish. To select a different finish, replace Z00 with the relevant colour code. For example, HydroTap GS BCS20 Classic in a Matte Black finish use code H51760Z03AU.

#### KEY TO ICONS

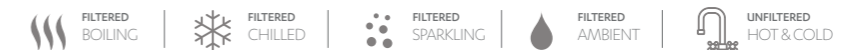

\*240 boiling cup per hour models include additional Booster and require 2 x 10 amp power GPOs. Refer to zipwater.com for full specification details.

Size relates to command centre - revert to installation diagram for clearance and ventilation.

Glass size is 200ml and cup size 167ml.

'Ambient' describes the temperature of the water where there is no additional heating or chilling to the incoming cold water supply.

# Commercial HydroTap

## CLASSIC WITH ARC MIXER

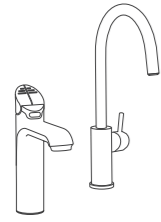

ORDER CODE	NO. PEOPLE	MODEL	WATER OPTIONS	CUPS PER HOUR	GLASSES PER HOUR	SIZE* H x W x D (mm)
H51875Z00AU	60	BCSHA		160	175	333 x 395 x 464
H51876Z00AU	100			240*	175	333 x 395 x 464
H51821Z00AU	20	BCHA		100	75	333 x 280 x 455
H51822Z00AU	40			160	125	333 x 395 x 464
H51823Z00AU	60			160	175	333 x 395 x 464
H51824Z00AU	100			240*	175	333 x 395 x 464
H51856Z00AU	60	BHA		160	-	333 x 280 x 313
H51857Z00AU	100			240*	-	333 x 280 x 313

## CLASSIC WITH CUBE MIXER

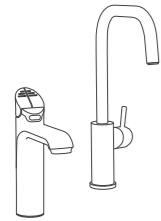

H51975Z00AU	60	BCSHA		160	175	333 x 395 x 464
H51976Z00AU	100			240*	175	333 x 395 x 464
H51921Z00AU	20	BCHA		100	75	333 x 280 x 455
H51922Z00AU	40			160	125	333 x 395 x 464
H51923Z00AU	60			160	175	333 x 395 x 464
H51924Z00AU	100			240*	175	333 x 395 x 464
H51956Z00AU	60	BHA		160	-	333 x 280 x 313
H51957Z00AU	100			240*	-	333 x 280 x 313

## CLASSIC ALL-IN-ONE

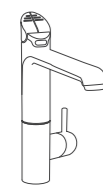

H5A775Z00AU	60	BCSHA		160	175	333 x 395 x 464
H5A776Z00AU	100			240*	175	333 x 395 x 464
H5A722Z00AU	40	BCHA		160	125	333 x 395 x 464
H5A723Z00AU	60			160	175	333 x 395 x 464
H5A724Z00AU	100			240*	175	333 x 395 x 464

### AVAILABLE IN:

#### POPULAR



Order code listed above is for Chrome finish. To select a different finish, replace Z00 with the relevant colour code. For example, HydroTap GS BCSHA60 Classic with Arc Mixer in a Matte Black finish use code H51875Z03AU.

#### KEY TO ICONS

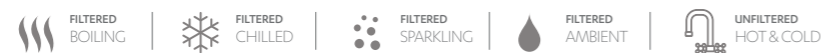

\*240 boiling cup per hour models include additional Booster and require 2 x 10 amp power GPOs. Refer to zipwater.com for full specification details.

Size relates to command centre - revert to installation diagram for clearance and ventilation.

Glass size is 200ml and cup size 167ml.

'Ambient' describes the temperature of the water where there is no additional heating or chilling to the incoming cold water supply.

## CLASSIC INDUSTRIAL SIDE TOUCH\*\*

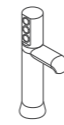

ORDER CODE	NO. PEOPLE	MODEL	WATER OPTIONS	CUPS PER HOUR	GLASSES PER HOUR	SIZE* H x W x D (mm)
H5J703Z00AU	40	BC		160	125	333 x 395 x 464
H5J704Z00AU	60			160	175	333 x 395 x 464
H5J705Z00AU	100			240*	175	333 x 395 x 464

## CLASSIC INDUSTRIAL TOP TOUCH\*\*

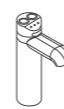

H5I703Z00AU	40	BC		160	125	333 x 395 x 464
H5I704Z00AU	60			160	175	333 x 395 x 464
H5I705Z00AU	100			240*	175	333 x 395 x 464

## MICRO

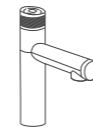

M1005AU	10	BC		90	60	340 x 180 x 502
M1001AU	10	B		90	-	340 x 180 x 270

## ULTRACARE\*\*



H557U1Z00AUC



H5D7U1Z00AUC



H5W7U1Z00AUC

H5W7U1Z00AUC	40	BCU		160	125	333 x 395 x 464
H5D7U1Z00AUC	40	BCU		160	125	333 x 395 x 464
H557U1Z00AUC	40	BCU		160	125	333 x 395 x 464

### AVAILABLE IN:

#### POPULAR

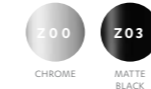

Order code listed above is for Chrome finish.

#### KEY TO ICONS

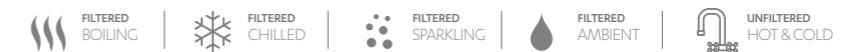

\*240 boiling cup per hour models include additional Booster and require 2 x 10 amp power GPOs. Refer to zipwater.com for full specification details.

Size relates to command centre - revert to installation diagram for clearance and ventilation.

Glass size is 200ml and cup size 167ml.

\*\*Industrial & UltraCare products only available in Chrome finish.

'Ambient' describes the temperature of the water where there is no additional heating or chilling to the incoming cold water supply.

# Commercial HydroTap

## ARC PLUS

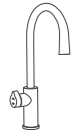

ORDER CODE	NO. PEOPLE	MODEL	WATER OPTIONS	CLIPS		SIZE* H x W x D (mm)
				PER HOUR	PER HOUR	
H5L760Z00AU	20	BCS		100	75	333 x 339 x 460
H5L762Z00AU	60			160	175	333 x 395 x 464
H5L763Z00AU	100			240*	175	333 x 395 x 464
H5L702Z00AU	20	BC		100	75	333 x 280 x 455
H5L703Z00AU	40			160	125	333 x 395 x 464
H5L704Z00AU	60			160	175	333 x 395 x 464
H5L705Z00AU	100			240*	175	333 x 395 x 464
H5L708Z00AU	60	BA		160	-	333 x 280 x 313
H5L709Z00AU	100			240*	-	333 x 280 x 313
H5L706Z00AU	60	B		160	-	333 x 280 x 313
H5L707Z00AU	100			240*	-	333 x 280 x 313
H5L765Z00AU	100	CS		-	150	333 x 280 x 480
H5L710Z00AU	40	C		-	125	333 x 280 x 476
H5L711Z00AU	100			-	150	333 x 280 x 476

## CUBE PLUS

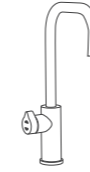

ORDER CODE	NO. PEOPLE	MODEL	WATER OPTIONS	CLIPS		SIZE* H x W x D (mm)
				PER HOUR	PER HOUR	
H5C760Z00AU	20	BCS		100	75	333 x 339 x 460
H5C762Z00AU	60			160	175	333 x 395 x 464
H5C763Z00AU	100			240*	175	333 x 395 x 464
H5C702Z00AU	20	BC		100	75	333 x 280 x 455
H5C703Z00AU	40			160	125	333 x 395 x 464
H5C704Z00AU	60			160	175	333 x 395 x 464
H5C705Z00AU	100			240*	175	333 x 395 x 464
H5C708Z00AU	60	BA		160	-	333 x 280 x 313
H5C709Z00AU	100			240*	-	333 x 280 x 313
H5C706Z00AU	60	B		160	-	333 x 280 x 313
H5C707Z00AU	100			240*	-	333 x 280 x 313
H5C765Z00AU	100	CS		-	150	333 x 280 x 480
H5C710Z00AU	40	C		-	125	333 x 280 x 476
H5C711Z00AU	100			-	150	333 x 280 x 476

## ARC PLUS WITH ARC MIXER



H5L875Z00AU	60	BCSHA		160	175	333 x 395 x 464
H5L876Z00AU	100			240*	175	333 x 395 x 464
H5L822Z00AU	40	BCHA		160	125	333 x 395 x 464
H5L823Z00AU	60			160	175	333 x 395 x 464
H5L824Z00AU	100			240*	175	333 x 395 x 464
H5L856Z00AU	60	BHA		160	-	333 x 280 x 313
H5L857Z00AU	100			240*	-	333 x 280 x 313

## CUBE PLUS WITH CUBE MIXER

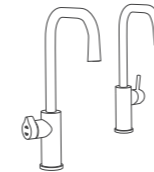

H5C975Z00AU	60	BCSHA		160	175	333 x 395 x 464
H5C976Z00AU	100			240*	175	333 x 395 x 464
H5C922Z00AU	40	BCHA		160	125	333 x 395 x 464
H5C923Z00AU	60			160	175	333 x 395 x 464
H5C924Z00AU	100			240*	175	333 x 395 x 464
H5C956Z00AU	60	BHA		160	-	333 x 280 x 313
H5C957Z00AU	100			240*	-	333 x 280 x 313

### AVAILABLE IN:



Order code listed above is for Chrome finish. To select a different finish, replace Z00 with the relevant colour code. For example, HydroTap GS BCS20 Arc in a Matte Black finish use code H52760Z03AU.



\*240 boiling cup per hour models include additional Booster and require 2 x 10 amp power GPOs. Refer to zipwater.com for full specification details.

Size relates to command centre - revert to installation diagram for clearance and ventilation.

Glass size is 200ml and cup size 167ml.

'Ambient' describes the temperature of the water where there is no additional heating or chilling to the incoming cold water supply.

### AVAILABLE IN:



Order code listed above is for Chrome finish. To select a different finish, replace Z00 with the relevant colour code. For example, HydroTap GS BCS20 Cube in a Matte Black finish use code H53760Z03AU.



\*240 boiling cup per hour models include additional Booster and require 2 x 10 amp power GPOs. Refer to zipwater.com for full specification details.

Size relates to command centre - revert to installation diagram for clearance and ventilation.

Glass size is 200ml and cup size 167ml.

'Ambient' describes the temperature of the water where there is no additional heating or chilling to the incoming cold water supply.

# Commercial HydroTap

## ELITE PLUS

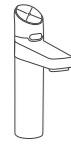

ORDER CODE	NO. PEOPLE	MODEL	WATER OPTIONS	CUPS PER HOUR	GLASSES PER HOUR	SIZE* H x W x D (mm)
H5E760Z00AU	20	BCS		100	75	333 x 339 x 460
H5E762Z00AU	60			160	175	333 x 395 x 464
H5E763Z00AU	100			240*	175	333 x 395 x 464
H5E702Z00AU	20	BC		100	75	333 x 280 x 455
H5E703Z00AU	40			160	125	333 x 395 x 464
H5E704Z00AU	60			160	175	333 x 395 x 464
H5E705Z00AU	100			240*	175	333 x 395 x 464
H5E708Z00AU	60	BA		160	-	333 x 280 x 313
H5E709Z00AU	100			240*	-	333 x 280 x 313
H5E706Z00AU	60	B		160	-	333 x 280 x 313
H5E707Z00AU	100			240*	-	333 x 280 x 313
H5E765Z00AU	100	CS		-	150	333 x 280 x 480
H5E710Z00AU	40	C		-	125	333 x 280 x 476
H5E711Z00AU	100			-	150	333 x 280 x 476

## ELITE PLUS WITH CLASSIC MIXER

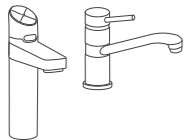

H5E675Z00AU	60	BCSHA		160	175	333 x 395 x 464
H5E676Z00AU	100			240*	175	333 x 395 x 464
H5E622Z00AU	40	BCHA		160	125	333 x 395 x 464
H5E623Z00AU	60			160	175	333 x 395 x 464
H5E624Z00AU	100			240*	175	333 x 395 x 464
H5E656Z00AU	60	BHA		160	-	333 x 280 x 313
H5E657Z00AU	100			240*	-	333 x 280 x 313

## AVAILABLE IN:



Order code listed above is for Chrome finish. To select a different finish, replace Z00 with the relevant colour code. For example, HydroTap G5 BCS20 Elite Plus in a Matte Black finish use code H5E760Z03AU.

## KEY TO ICONS

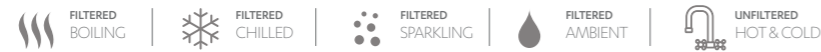

\*240 boiling cup per hour models include additional Booster and require 2 x 10 amp power GPOs. Refer to zipwater.com for full specification details.

Size relates to command centre - revert to installation diagram for clearance and ventilation.

Glass size is 200ml and cup size 167ml.

'Ambient' describes the temperature of the water where there is no additional heating or chilling to the incoming cold water supply.

## ELITE PLUS WITH ARC MIXER

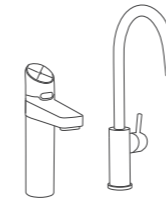

ORDER CODE	NO. PEOPLE	MODEL	WATER OPTIONS	CUPS PER HOUR	GLASSES PER HOUR	SIZE* H x W x D (mm)
H5E875Z00AU	60	BCSHA		160	175	333 x 395 x 464
H5E876Z00AU	100			240*	175	333 x 395 x 464
H5E822Z00AU	40			BCHA		160
H5E823Z00AU	60	160	175			333 x 395 x 464
H5E824Z00AU	100	240*	175			333 x 395 x 464
H5E856Z00AU	60	BHA		160	-	333 x 280 x 313
H5E857Z00AU	100			240*	-	333 x 280 x 313

## ELITE PLUS WITH CUBE MIXER

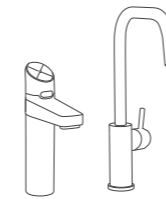

ORDER CODE	NO. PEOPLE	MODEL	WATER OPTIONS	CUPS PER HOUR	GLASSES PER HOUR	SIZE* H x W x D (mm)
H5E975Z00AU	60	BCSHA		160	175	333 x 395 x 464
H5E976Z00AU	100			240*	175	333 x 395 x 464
H5E922Z00AU	40	BCHA		160	125	333 x 395 x 464
H5E923Z00AU	60			160	175	333 x 395 x 464
H5E924Z00AU	100			240*	175	333 x 395 x 464
H5E956Z00AU	60	BHA		160	-	333 x 280 x 313
H5E957Z00AU	100			240*	-	333 x 280 x 313

## AVAILABLE IN:



Order code listed above is for Chrome finish. To select a different finish, replace Z00 with the relevant colour code. For example, HydroTap G5 BCSHA60 5-In-1 Elite Plus tap with Arc Mixer in a Matte Black finish use code H5E875Z03AU.

## KEY TO ICONS

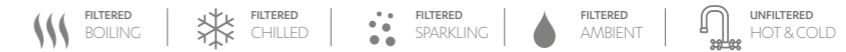

\*240 boiling cup per hour models include additional Booster and require 2 x 10 amp power GPOs. Refer to zipwater.com for full specification details.

Size relates to command centre - revert to installation diagram for clearance and ventilation.

Glass size is 200ml and cup size 167ml.

'Ambient' describes the temperature of the water where there is no additional heating or chilling to the incoming cold water supply.

# Commercial HydroTap

CELSIUS ALL-IN-ONE\*\*

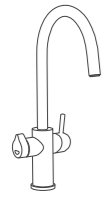

ORDER CODE	NO. PEOPLE	MODEL	WATER OPTIONS	CUPS PER HOUR	GLASSES PER HOUR	SIZE* H x W x D (mm)
H57760Z00AU	20	BCSHA		100	75	333 x 339 x 460
H57762Z00AU	60			160	175	333 x 395 x 464
H57763Z00AU	100			240*	175	333 x 395 x 464
H57702Z00AU	20	BCHA		100	75	333 x 280 x 455
H57703Z00AU	40			160	125	333 x 395 x 464
H57704Z00AU	60			160	175	333 x 395 x 464
H57705Z00AU	100			240	175	333 x 395 x 464

CELSIUS ARC\*\*

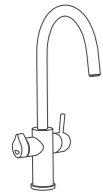

ORDER CODE	NO. PEOPLE	MODEL	WATER OPTIONS	CUPS PER HOUR	GLASSES PER HOUR	SIZE* H x W x D (mm)
H58706Z00AU	60	B		160	-	333 x 280 x 313
H58707Z00AU	100			240*	-	333 x 280 x 313
H58765Z00AU	100	CS		-	150	333 x 280 x 480
H58711Z00AU	100	C		-	150	333 x 280 x 476

CELSIUS CUBE\*\*

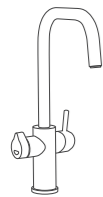

MODEL CODE	NO. PEOPLE	MODEL	WATER OPTIONS	CUPS PER HOUR	GLASSES PER HOUR	SIZE* H x W x D (mm)
H59706Z00AU	60	B		160	-	333 x 280 x 313
H59707Z00AU	100			240*	-	333 x 280 x 313
H59765Z00AU	100	CS		-	150	333 x 280 x 480
H59711Z00AU	100	C		-	150	333 x 280 x 476

\*\*Celsius products require a hot and cold water supply

AVAILABLE IN:

POPULAR



PLATINUM



Order code listed above is for Chrome finish. To select a different finish, replace Z00 with the relevant colour code. For example, HydroTap G5 BCSHA20 Elite in a Matte Black finish use code H57760Z03AU.

KEY TO ICONS

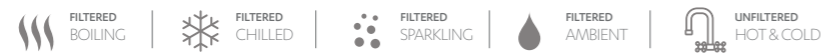

\*240 boiling cup per hour models include additional Booster and require 2 x 10 amp power GPOs. Refer to zipwater.com for full specification details.

Size relates to command centre - revert to installation diagram for clearance and ventilation.

Glass size is 200ml and cup size 167ml.

'Ambient' describes the temperature of the water where there is no additional heating or chilling to the incoming cold water supply.

# Technical information

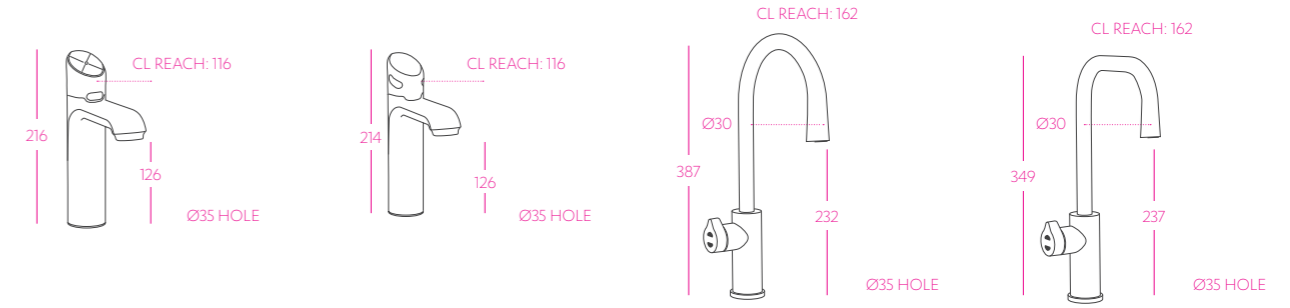

Classic Plus

Touch-Free Wave

Arc Plus

Cube Plus

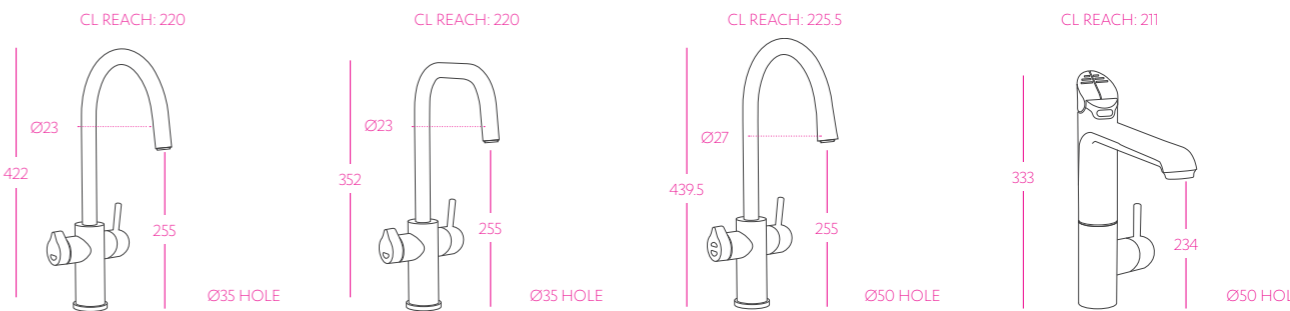

Celsius Arc

Celsius Cube

Celsius All-In-One

Classic All-In-One

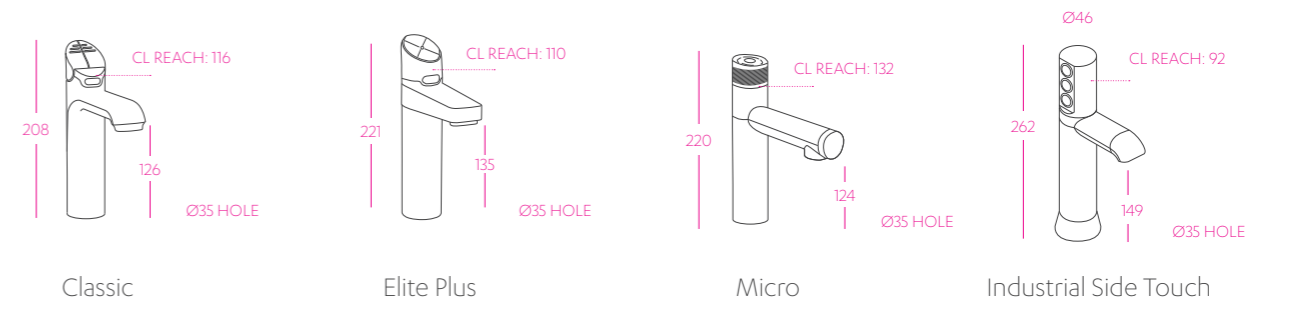

Classic

Elite Plus

Micro

Industrial Side Touch

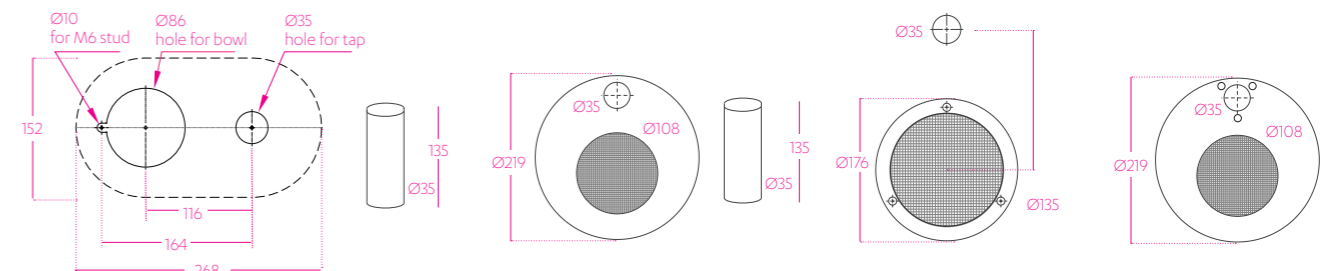

95258Z00

Zip font raised Chrome

Suits any current model Zip HydroTap Classic, Classic Plus, Touch-Free Wave, Miniboil Classic and Elite Plus

90915Z00

Zip font kit Chrome

Suits any current model Zip HydroTap Classic, Classic Plus, Touch-Free Wave, Miniboil Classic and Elite Plus

93441Z00

Zip stand alone font Chrome for HydroTap Arc Plus and Cube Plus

90869Z00

Font for Industrial in Chrome finish



# Technical information

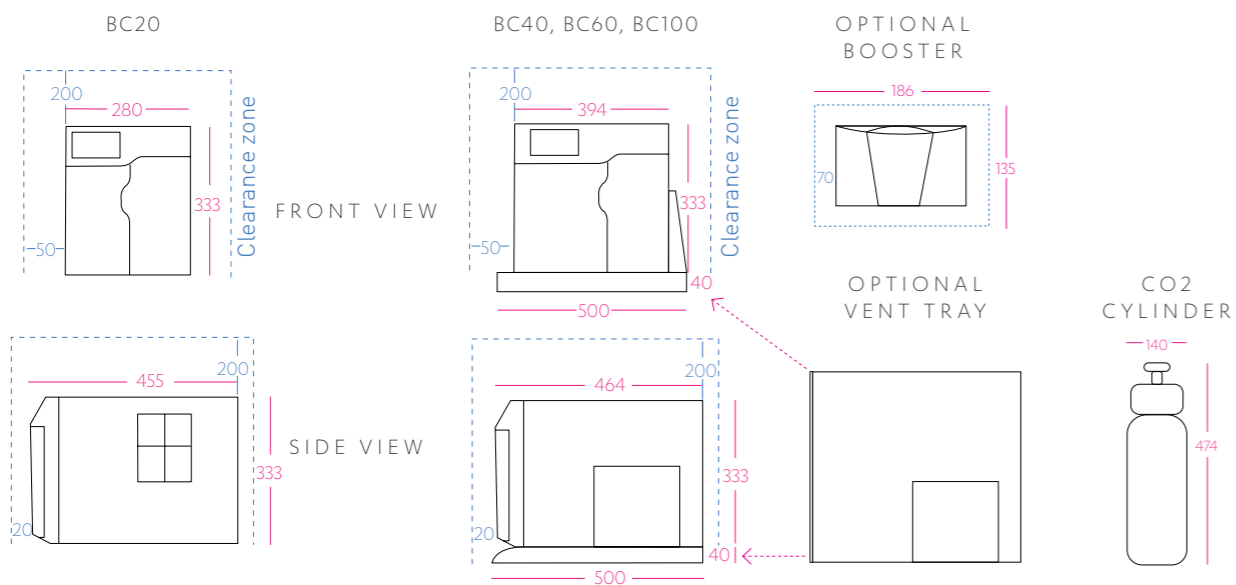

For full installation details please refer to the installation instructions which can be found at [zipwater.com](http://zipwater.com)  
 Be sure to allow additional space required if installing a sparkling model with CO2 cylinder.



Image shows BC40 command centre installed with vent tray

# Accessories





**90915Z00**  
 Zip font kit Chrome

Suits current model Zip HydroTap Classic, Classic Plus, Touch-Free Wave, Miniboil Classic and Elite Plus

Available in popular finish options only

POPULAR

  
Z00  
CHROME

  
Z01  
BRUSHED CHROME

  
Z03  
MATTE BLACK





**93441Z00**  
 Zip stand alone font Chrome

Suits current model HydroTap Arc Plus or Cube Plus. Does not include extension

Available in 7 colour finish options

POPULAR

  
Z00  
CHROME

  
Z01  
BRUSHED CHROME

  
Z03  
MATTE BLACK





**95258Z00**  
 Zip font raised Chrome

Suits current model Zip HydroTap Classic, Classic Plus, Touch-Free Wave, Miniboil Classic and Elite Plus

Available in 7 colour finish options

PLATINUM

  
Z05  
BRUSHED ROSE GOLD

  
Z07  
BRUSHED GOLD

  
Z09  
GUNMETAL

  
Z11  
BRUSHED NICKEL



**91564**  
 Zip BCS accessibility lever

Available in various configurations to suit your needs. Compatible with HydroTap Classic only



**91560**  
 Zip BC accessibility lever

# Installation accessories



**91412**

Zip HydroTap boiling water boost upgrade kit

Suits current Zip HydroTap with boiling water



**91394**

Zip 1.5m silicone tube replacement kit

Suits current commercial Zip HydroTap Classic excluding sparkling models



**93156**

Zip dual exhaust fan

Suits any current commercial Zip HydroTap with chilled water

# Consumables (filters & CO<sub>2</sub>)



**93702**

Zip 0.2 micron commercial filter

Suits any current model Zip HydroTap



**93703**

Zip 3 micron commercial filter

Suits any current model Zip HydroTap (for water with high sediment levels)



**93706**

Zip 0.2 micron non-carbon commercial filter

Suits any current model Zip HydroTap (Non-carbon filter do not remove chlorine)

**Australia**  
Zip Water  
1800 947 827  
zipwater.com



**93179**

Zip sparkling 2.6kg refillable cylinder

Suits any current commercial sparkling model Zip HydroTap



**93179-R**

Zip sparkling 2.6kg replacement cylinder

Available exclusively through the Zip HydroCare CO<sub>2</sub> exchange program



Copyright 2022. Zip reserves the right to change product specifications without notice. The term "Zip" is a trade mark of Zip Heaters (Aust) Pty Ltd. SteriTouch® and the SteriTouch logo are registered trade marks of SteriTouch Limited. As Zip's policy is one of continuous product improvement, changes to specifications may be made without prior notice. Products may not be exactly as depicted.



1800 947 827

[zipwater.com](http://zipwater.com)

2022 ZIP INDUSTRIES ALL RIGHTS RESERVED

Z1739  
NOV 2022